

**Panasonic**  
ideas for life

**GU (General Use)-E Type  
[1, 2-Channel (Form A)  
4, 6-Pin Type]**

**PhotoMOS  
RELAYS**

**FEATURES**

- 1. Low cost type.**
- 2. Reinforced insulation 5,000V type (DIP type)**  
More than 0.4mm internal insulation distance between inputs and outputs. Conforms to EN41003, EN60950 (reinforced insulation)
- 3. Various package design (DIP4, SOP4, DIP8, SOP8 packages are available)**
- 4. High sensitivity, Low ON resistance**  
Can control a maximum 0.5A (AQY282EH, AQW282EH) load current with a 5mA input current.  
Low ON resistance of 2.5Ω (AQY282EH, AQW282EH).  
Stable operation because there are no metallic contact parts.
- 5. Low-level off state leakage current**  
The SSR has an off state leakage current of several milliamperes, where as the PhotoMOS relay has only 100pA even with the rated load voltage of 350V (AQY280EH).

**TYPICAL APPLICATIONS**

- Modem
- Telephone equipment
- Security equipment
- Sensors
- Amusement

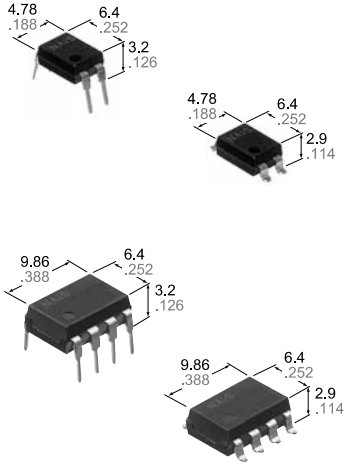

mm inch

**DIP TYPES**

**DIP 4pin**

Type	I/O isolation voltage	Output rating*		Part No.				Packing quantity
				Through hole terminal	Surface-mount terminal			
					Tube packing style		Tape and reel packing style	
Load voltage	Load current			Picked from the 1/2-pin side	Picked from the 3/4-pin side			
AC/DC type	Reinforced 5,000 V	60 V	500 mA	AQY282EH	AQY282EHA	AQY282EHAX	AQY282EHAZ	Tube: 1 tube contains 100 pcs. Tube: 1 batch contains 1,000 pcs. Tape and reel: 1,000 pcs.
		350 V	130 mA	AQY280EH	AQY280EHA	AQY280EHAX	AQY280EHAZ	
		400 V	120 mA	AQY284EH	AQY284EHA	AQY284EHAX	AQY284EHAZ	

\*Indicate the peak AC and DC values.

Note: For space reasons, the initial letters of the product number "AQY", the SMD terminal shape indicator "A" and the package type indicator "X" and "Z" are omitted from the seal.

**DIP 8pin**

Type	I/O isolation voltage	Output rating*		Part No.				Packing quantity
				Through hole terminal	Surface-mount terminal			
					Tube packing style		Tape and reel packing style	
Load voltage	Load current			Picked from the 1/2/3/4-pin side	Picked from the 5/6/7/8-pin side			
AC/DC type	Reinforced 5,000 V	60 V	400 mA	AQW282EH	AQW282EHA	AQW282EHAX	AQW282EHAZ	Tube: 1 tube contains 40 pcs. Tube: 1 batch contains 400 pcs. Tape and reel: 1,000 pcs.
		350 V	120 mA	AQW280EH	AQW280EHA	AQW280EHAX	AQW280EHAZ	
		400 V	100 mA	AQW284EH	AQW284EHA	AQW284EHAX	AQW284EHAZ	

\*Indicate the peak AC and DC values.

Note: For space reasons, the SMD terminal shape indicator "A" and the package type indicator "X" and "Z" are omitted from the seal.

**RATING**

## 1. Absolute maximum ratings (Ambient temperature: 25°C 77°F)

## DIP 4pin

Item		Symbol	AQY282EH	AQY280EH	AQY284EH	Remarks
Input	LED forward current	$I_F$	50 mA			
	LED reverse voltage	$V_R$	5 V			
	Peak forward current	$I_{FP}$	1 A			f = 100 Hz, Duty factor = 0.1%
	Power dissipation	$P_{in}$	75 mW			
Output	Load voltage (peak AC)	$V_L$	60 V	350 V	400 V	
	Continuous load current (peak AC)	$I_L$	0.5 A	0.13 A	0.12 A	
	Peak load current	$I_{peak}$	1.5 A	0.4 A	0.3 A	100 ms (1 shot), $V_L = DC$
	Power dissipation	$P_{out}$	500 mW			
Total power dissipation		$P_T$	550 mW			
I/O isolation voltage		$V_{iso}$	5,000 V AC			
Operating temperature		$T_{opr}$	-40°C to +85°C -40°F to +185°F			Non-condensing at low temperature
Storage temperature		$T_{stg}$	-40°C to +100°C -40°F to +212°F			

## DIP 8pin

Item		Symbol	AQW282EH	AQW280EH	AQW284EH	Remarks
Input	LED forward current	$I_F$	50 mA			
	LED reverse voltage	$V_R$	5 V			
	Peak forward current	$I_{FP}$	1 A			f = 100 Hz, Duty factor = 0.1%
	Power dissipation	$P_{in}$	75 mW			
Output	Load voltage (peak AC)	$V_L$	60 V	350 V	400 V	
	Continuous load current (peak AC)	$I_L$	0.4 (0.5) A	0.12 (0.14) A	0.1 (0.13) A	( ): in case of using only 1 channel
	Peak load current	$I_{peak}$	1.2 A	0.36 A	0.3 A	100 ms (1 shot), $V_L = DC$
	Power dissipation	$P_{out}$	800 mW			
Total power dissipation		$P_T$	850 mW			
I/O isolation voltage		$V_{iso}$	5,000 V AC			
Operating temperature		$T_{opr}$	-40°C to +85°C -40°F to +185°F			Non-condensing at low temperature
Storage temperature		$T_{stg}$	-40°C to +100°C -40°F to +212°F			

## 2. Electrical characteristics (Ambient temperature: 25°C 77°F)

## DIP4pin

Item			Symbol	AQY282EH	AQY280EH	AQY284EH	Condition
Input	LED operate current	Typical	$I_{Fon}$	1.8 mA			$I_L = Max.$
		Maximum		3.0 mA			
	LED turn off current	Minimum	$I_{Foff}$	0.2 mA			$I_L = Max.$
		Typical		1.6 mA			
LED dropout voltage	Typical	$V_F$	1.14 V (1.25 V at $I_F = 50mA$ )			$I_F = 5 mA$	
	Maximum		1.5 V				
Output	On resistance	Typical	$R_{on}$	0.85Ω	20Ω	28Ω	$I_F = 5 mA$ $I_L = Max.$ Within 1 s on time
		Maximum		2.5Ω	25Ω	35Ω	
	Off state leakage current	Maximum	$I_{Leak}$	1μA			$I_F = 0 mA$ $V_L = Max.$
Transfer characteristics	Turn on time*	Typical	$T_{on}$	1.8 ms	1.5 ms		$I_F = 5 mA$ $I_L = Max.$
		Maximum		5 ms			
	Turn off time*	Typical	$T_{off}$	0.5 ms			$I_F = 5 mA$ $I_L = Max.$
		Maximum		2 ms			
	I/O capacitance	Typical	$C_{iso}$	0.8 pF			f = 1 MHz $V_B = 0V$
Maximum		1.5 pF					
Initial I/O isolation resistance	Minimum	$R_{iso}$	1,000 MΩ			500 V DC	

# AQO280EH

DIP8pin

Item		Symbol	AQW282EH	AQW280EH	AQW284EH	Condition
Input	LED operate current	Typical	1.8 mA			$I_L = \text{Max.}$
		Maximum	3.0 mA			
	LED turn off current	Minimum	0.2 mA			$I_L = \text{Max.}$
		Typical	1.6 mA			
LED dropout voltage	Typical	1.14 V (1.25 V at $I_F = 50\text{mA}$ )			$I_F = 5 \text{ mA}$	
	Maximum	1.5 V				
Output	On resistance	Typical	0.85Ω	20Ω	28Ω	$I_F = 5 \text{ mA}$ $I_L = \text{Max.}$ Within 1 s on time
		Maximum	2.5Ω	25Ω	35Ω	
	Off state leakage current	Maximum	1μA			$I_F = 0 \text{ mA}$ $V_L = \text{Max.}$
Transfer characteristics	Turn on time*	Typical	1.8 ms	1.5 ms		$I_F = 5 \text{ mA}$ $I_L = \text{Max.}$
		Maximum	5 ms			
	Turn off time*	Typical	0.5 ms			$I_F = 5 \text{ mA}$ $I_L = \text{Max.}$
		Maximum	2 ms			
	I/O capacitance	Typical	0.8 pF			$f = 1 \text{ MHz}$ $V_B = 0\text{V}$
Maximum		1.5 pF				
Initial I/O isolation resistance	Minimum	$R_{iso}$	1,000 MΩ		500 V DC	

\*Turn on/Turn off time

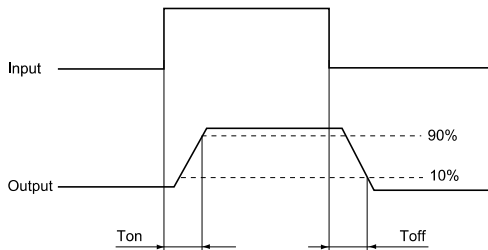

3-4 the terminal leads receive solder plating or solder dip plating.

## REFERENCE DATA

[DIP type]

1. Load current vs. ambient temperature characteristics

Allowable ambient temperature: -40°C to +85°C  
-40°F to +185°F

Type of connection: A

(1) AQY282EH

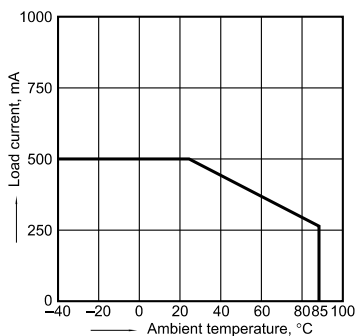

(2) AQY280EH, AQY284EH

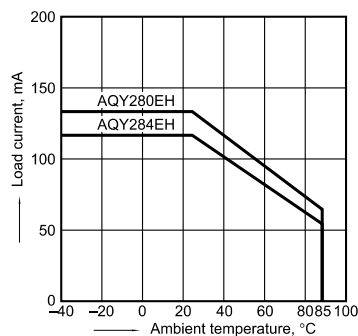

(3) AQW282EH

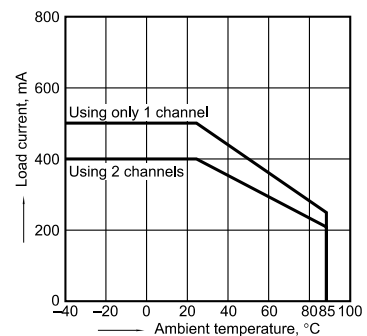

**DIMENSIONS**

**AQY28○S**

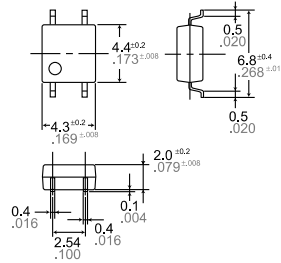

Recommended mounting pad  
(Top view)

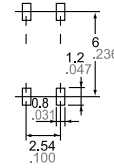

Terminal thickness =  $0.15 \pm 0.006$   
General tolerance:  $\pm 0.1 \pm 0.004$

Tolerance:  $\pm 0.1 \pm 0.004$

**AQW28○S**

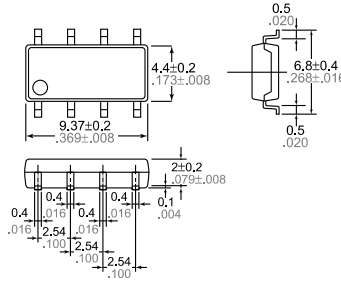

Recommended mounting pad  
(Top view)

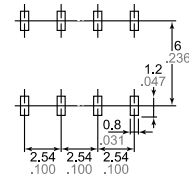

Terminal thickness =  $0.15 \pm 0.006$   
General tolerance:  $\pm 0.1 \pm 0.004$

Tolerance:  $\pm 0.1 \pm 0.004$

**AQY28○EH(A)**



Through hole terminal type

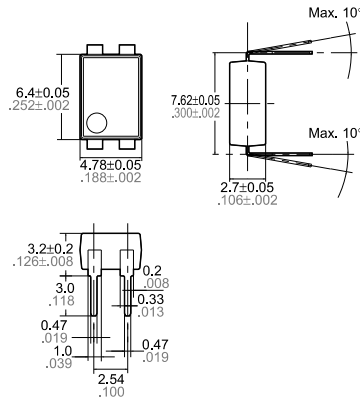

Terminal thickness =  $0.2 \pm 0.008$   
General tolerance:  $\pm 0.1 \pm 0.004$

Surface mount terminal type

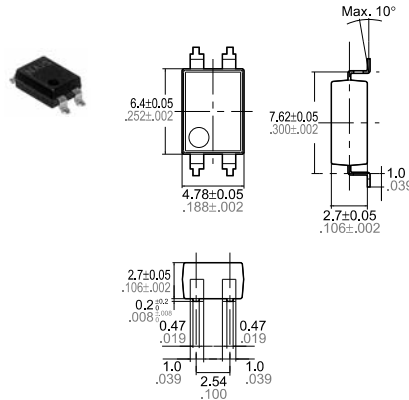

Terminal thickness =  $0.2 \pm 0.008$   
General tolerance:  $\pm 0.1 \pm 0.004$

PC board pattern (Bottom view)

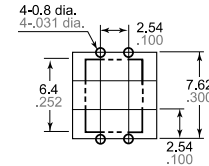

Tolerance:  $\pm 0.1 \pm 0.004$

Mounting pad (Top view)

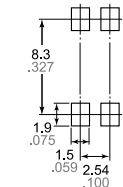

Tolerance:  $\pm 0.1 \pm 0.004$

**AQW28○EH(A)**



Through hole terminal type

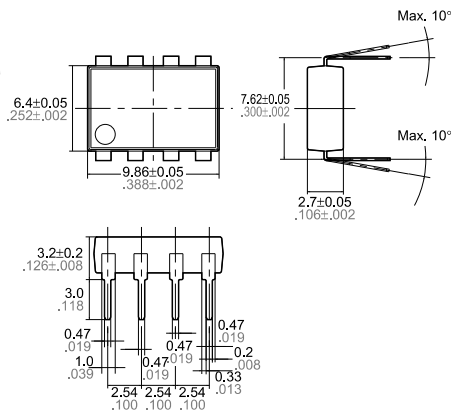

Terminal thickness =  $0.2 \pm 0.008$   
General tolerance:  $\pm 0.1 \pm 0.004$

Surface mount terminal type

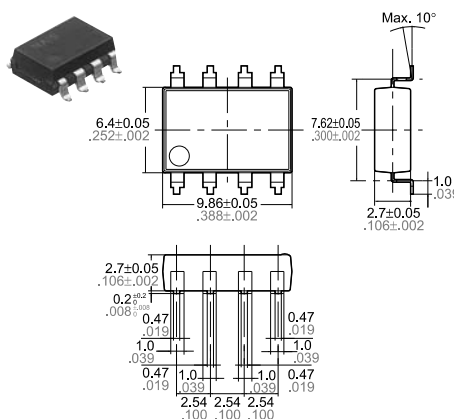

Terminal thickness =  $0.2 \pm 0.008$   
General tolerance:  $\pm 0.1 \pm 0.004$

PC board pattern  
(Bottom view)

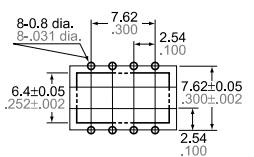

Tolerance:  $\pm 0.1 \pm 0.004$

Mounting pad (Top view)

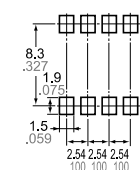

Tolerance:  $\pm 0.1 \pm 0.004$

# Mouser Electronics

Authorized Distributor

Click to View Pricing, Inventory, Delivery & Lifecycle Information:

Panasonic:

[AQY282S](#) [AQY280EH](#) [AQY282EH](#) [AQY282EHA](#) [AQY282EHAX](#) [AQY282EHAZ](#) [AQY282SZ](#) [AQY284EH](#)