

NTD2955, NVD2955

Power MOSFET

-60 V, -12 A, P-Channel DPAK

This Power MOSFET is designed to withstand high energy in the avalanche and commutation modes. Designed for low-voltage, high-speed switching applications in power supplies, converters, and power motor controls. These devices are particularly well suited for bridge circuits where diode speed and commutating safe operating areas are critical and offer an additional safety margin against unexpected voltage transients.

Features

- Avalanche Energy Specified
- I_{DSS} and $V_{DS(on)}$ Specified at Elevated Temperature
- Designed for Low-Voltage, High-Speed Switching Applications and to Withstand High Energy in the Avalanche and Commutation Modes
- NVD and SVD Prefix for Automotive and Other Applications Requiring Unique Site and Control Change Requirements; AEC-Q101 Qualified and PPAP Capable
- These Devices are Pb-Free and are RoHS Compliant

MAXIMUM RATINGS ($T_J = 25^\circ\text{C}$ unless otherwise noted)

Rating	Symbol	Value	Unit
Drain-to-Source Voltage	V_{DSS}	-60	Vdc
Gate-to-Source Voltage	V_{GS}	± 20	Vdc
- Continuous	V_{GSM}	± 25	Vpk
- Non-repetitive ($t_p \leq 10$ ms)			
Drain Current	I_D	-12	Adc
- Continuous @ $T_a = 25^\circ\text{C}$	I_{DM}	-18	Apk
- Single Pulse ($t_p \leq 10$ ms)			
Total Power Dissipation @ $T_a = 25^\circ\text{C}$	P_D	55	W
Operating and Storage Temperature Range	T_J, T_{stg}	-55 to 175	$^\circ\text{C}$
Single Pulse Drain-to-Source Avalanche Energy - Starting $T_J = 25^\circ\text{C}$ ($V_{DD} = 25$ Vdc, $V_{GS} = 10$ Vdc, Peak $I_L = 12$ Apk, $L = 3.0$ mH, $R_G = 25$ Ω)	E_{AS}	216	mJ
Thermal Resistance	$R_{\theta JC}$	2.73	$^\circ\text{C/W}$
- Junction-to-Case	$R_{\theta JA}$	71.4	
- Junction-to-Ambient (Note 1)	$R_{\theta JA}$	100	
- Junction-to-Ambient (Note 2)			
Maximum Lead Temperature for Soldering Purposes, 1/8 in. from case for 10 seconds	T_L	260	$^\circ\text{C}$

Stresses exceeding those listed in the Maximum Ratings table may damage the device. If any of these limits are exceeded, device functionality should not be assumed, damage may occur and reliability may be affected.

1. When surface mounted to an FR4 board using 1 in pad size (Cu area = 1.127 in²).
2. When surface mounted to an FR4 board using the minimum recommended pad size (Cu area = 0.412 in²).



ON Semiconductor®

www.onsemi.com

$V_{(BR)DSS}$	$R_{DS(on)}$ TYP	I_D MAX
-60 V	155 m Ω @ -10 V, 6 A	-12 A

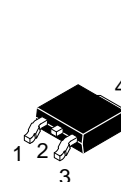
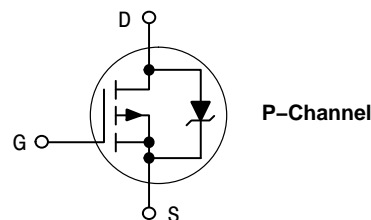

DPAK
CASE 369C
STYLE 2

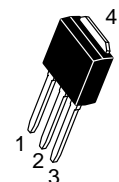

IPAK
CASE 369D
STYLE 2

MARKING DIAGRAMS & PIN ASSIGNMENTS

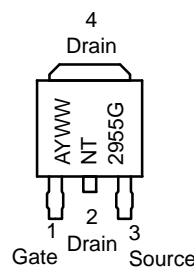

Gate Drain Source

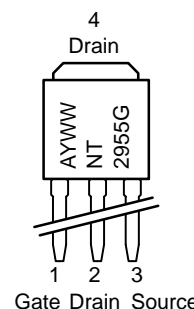

Gate Drain Source

- A = Assembly Location*
- NT2955/NV2955 = Specific Device Code (DPAK)
- NT2955 = Specific Device Code (IPAK)
- Y = Year
- WW = Work Week
- G = Pb-Free Package

* The Assembly Location code (A) is front side optional. In cases where the Assembly Location is stamped in the package, the front side assembly code may be blank.

ORDERING INFORMATION

See detailed ordering and shipping information on page 5 of this data sheet.

NTD2955, NVD2955

ELECTRICAL CHARACTERISTICS (T_J = 25°C unless otherwise noted)

Characteristic	Symbol	Min	Typ	Max	Unit
----------------	--------	-----	-----	-----	------

OFF CHARACTERISTICS

Drain-to-Source Breakdown Voltage (Note 3) (V _{GS} = 0 Vdc, I _D = -0.25 mA) (Positive Temperature Coefficient)	V _{(BR)DSS}	-60 -	- 67	- -	Vdc mV/°C
Zero Gate Voltage Drain Current (V _{GS} = 0 Vdc, V _{DS} = -60 Vdc, T _J = 25°C) (V _{GS} = 0 Vdc, V _{DS} = -60 Vdc, T _J = 150°C)	I _{DSS}	- -	- -	-10 -100	μAdc
Gate-Body Leakage Current (V _{GS} = ± 20 Vdc, V _{DS} = 0 Vdc)	I _{GSS}	-	-	-100	nAdc

ON CHARACTERISTICS (Note 3)

Gate Threshold Voltage (V _{DS} = V _{GS} , I _D = -250 μAdc) (Negative Temperature Coefficient)	V _{GS(th)}	-2.0 -	-2.8 4.5	-4.0 -	Vdc mV/°C
Static Drain-Source On-State Resistance (V _{GS} = -10 Vdc, I _D = -6.0 Adc)	R _{DS(on)}	-	0.155	0.180	Ω
Drain-to-Source On-Voltage (V _{GS} = -10 Vdc, I _D = -12 Adc) (V _{GS} = -10 Vdc, I _D = -6.0 Adc, T _J = 150°C)	V _{DS(on)}		-1.86 -	-2.6 -2.0	Vdc
Forward Transconductance (V _{DS} = 10 Vdc, I _D = 6.0 Adc)	g _{FS}		8.0	-	Mhos

DYNAMIC CHARACTERISTICS

Input Capacitance	(V _{DS} = -25 Vdc, V _{GS} = 0 Vdc, F = 1.0 MHz)	C _{iSS}	-	500	750	pF
Output Capacitance		C _{oSS}	-	150	250	
Reverse Transfer Capacitance		C _{rSS}	-	50	100	

SWITCHING CHARACTERISTICS (Notes 3 and 4)

Turn-On Delay Time	(V _{DD} = -30 Vdc, I _D = -12 A, V _{GS} = -10 V, R _G = 9.1 Ω)	t _{d(on)}	-	10	20	ns
Rise Time		t _r	-	45	85	
Turn-Off Delay Time		t _{d(off)}	-	26	40	
Fall Time		t _f	-	48	90	
Gate Charge	(V _{DS} = -48 Vdc, V _{GS} = -10 Vdc, I _D = -12 A)	Q _T	-	15	30	nC
		Q _{GS}	-	4.0	-	
		Q _{GD}	-	7.0	-	

DRAIN-SOURCE DIODE CHARACTERISTICS (Note 3)

Diode Forward On-Voltage (I _S = 12 Adc, V _{GS} = 0 V) (I _S = 12 Adc, V _{GS} = 0 V, T _J = 150°C)	V _{SD}	- -	-1.6 -1.3	-2.5 -	Vdc
Reverse Recovery Time (I _S = 12 A, di _S /dt = 100 A/μs, V _{GS} = 0 V)	t _{rr}	-	50		ns
	t _a	-	40	-	
	t _b	-	10	-	
Reverse Recovery Stored Charge	Q _{RR}	-	0.10	-	μC

Product parametric performance is indicated in the Electrical Characteristics for the listed test conditions, unless otherwise noted. Product performance may not be indicated by the Electrical Characteristics if operated under different conditions.

3. Indicates Pulse Test: Pulse Width ≤ 300 μs, Duty Cycle ≤ 2%.

4. Switching characteristics are independent of operating junction temperature.

NTD2955, NVD2955

TYPICAL PERFORMANCE CURVES ($T_J = 25^\circ\text{C}$ unless otherwise noted)

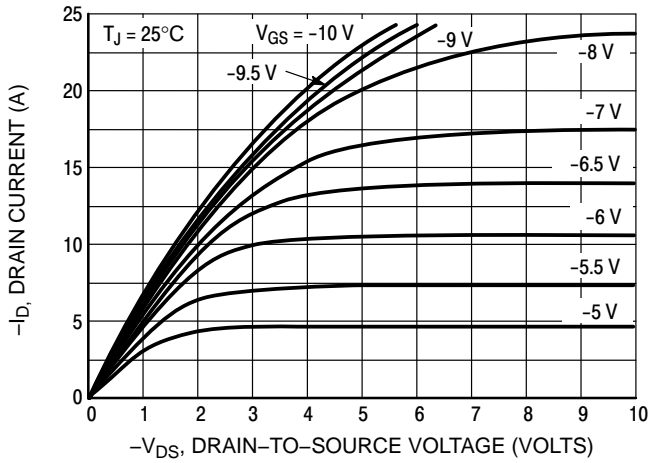

Figure 1. On-Region Characteristics

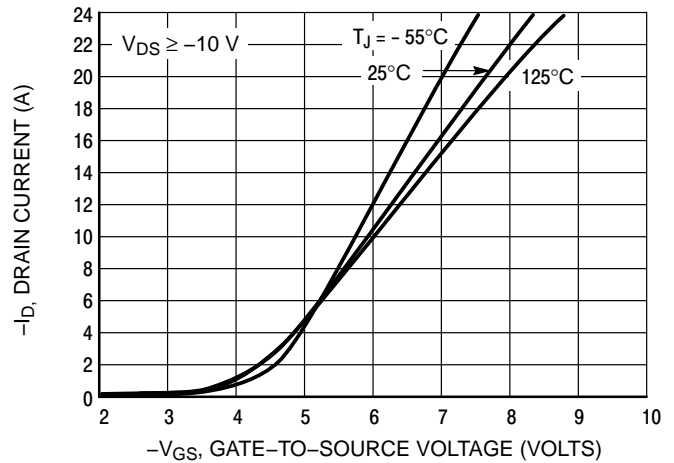

Figure 2. Transfer Characteristics

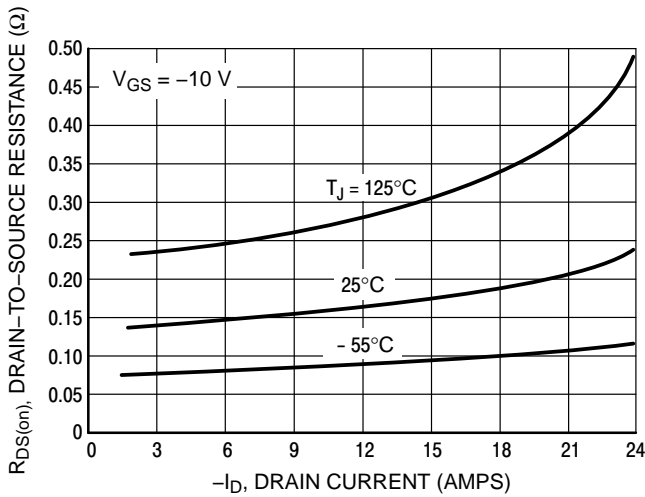

Figure 3. On-Resistance versus Drain Current and Temperature

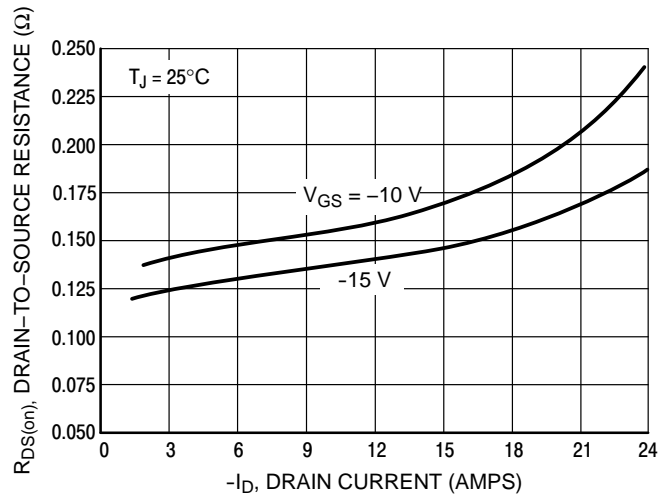

Figure 4. On-Resistance versus Drain Current and Gate Voltage

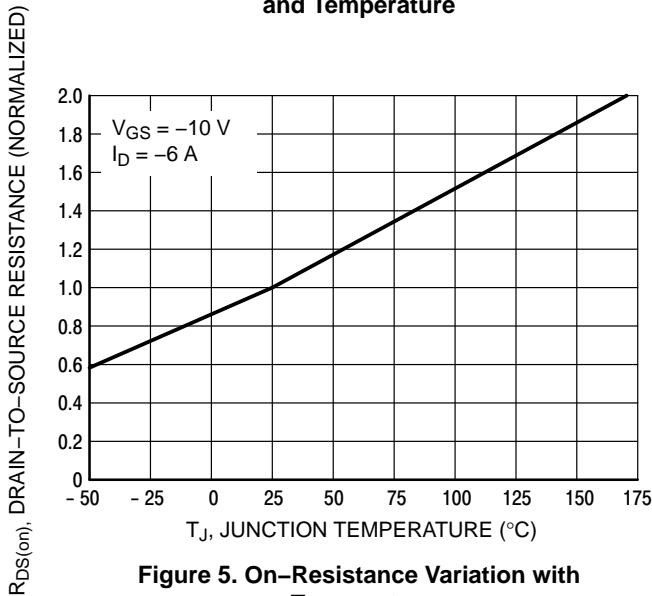

Figure 5. On-Resistance Variation with Temperature

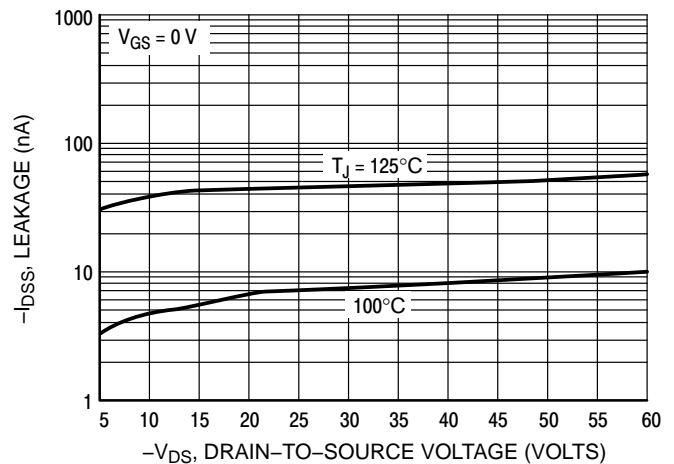

Figure 6. Drain-To-Source Leakage Current versus Voltage

NTD2955, NVD2955

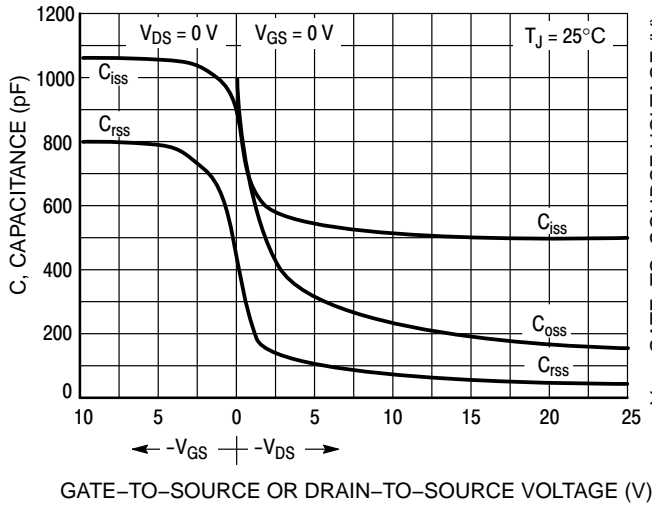

Figure 7. Capacitance Variation

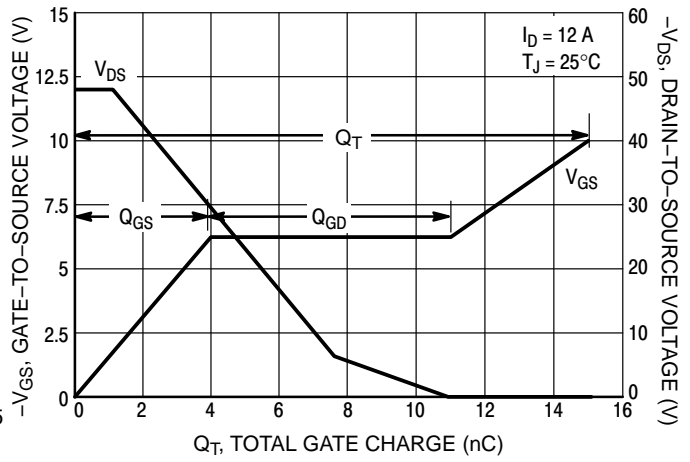

Figure 8. Gate-To-Source and Drain-To-Source Voltage versus Total Charge

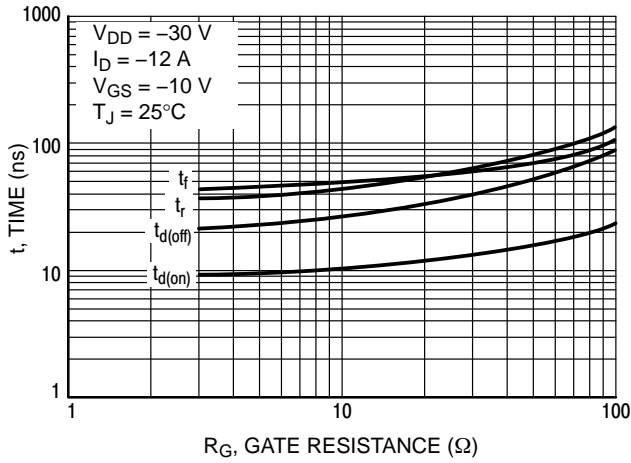

Figure 9. Resistive Switching Time Variation versus Gate Resistance

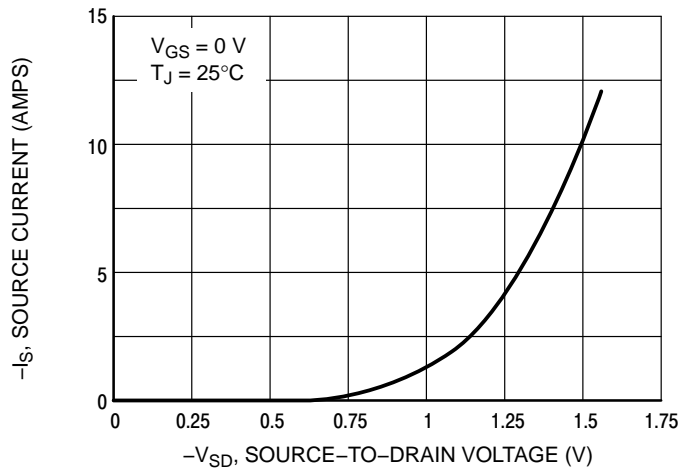

Figure 10. Diode Forward Voltage versus Current

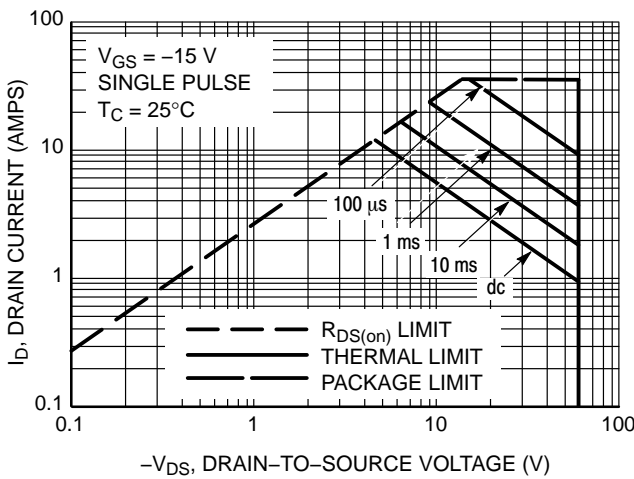

Figure 11. Maximum Rated Forward Biased Safe Operating Area

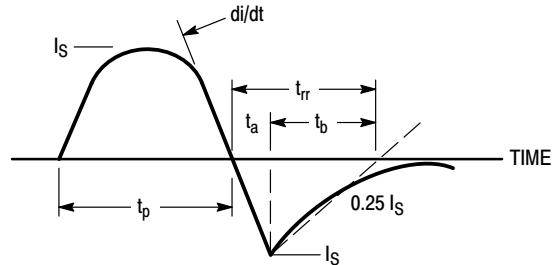

Figure 12. Diode Reverse Recovery Waveform

NTD2955, NVD2955

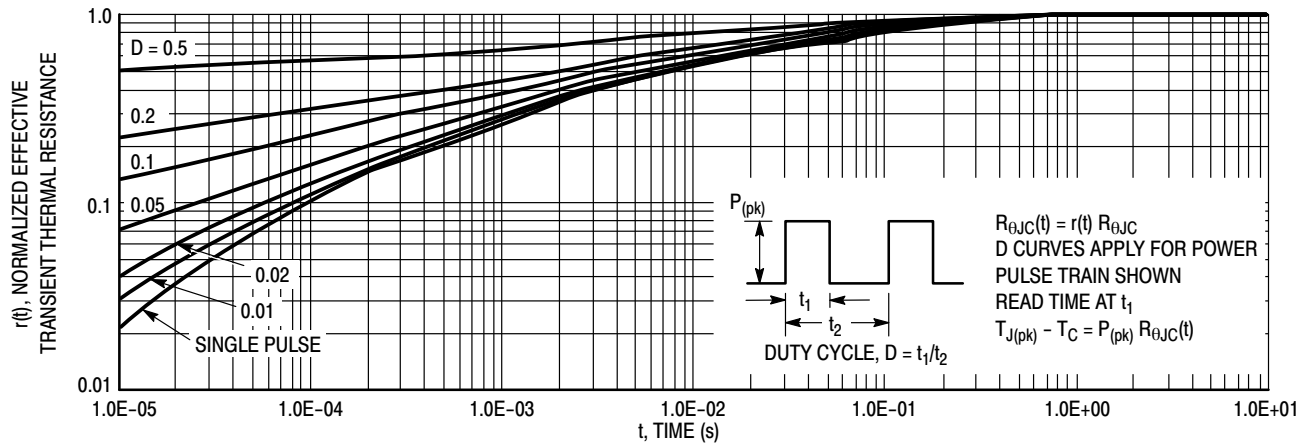

Figure 13. Thermal Response

ORDERING INFORMATION

Device	Package	Shipping [†]
NTD2955G	DPAK (Pb-Free)	75 Units / Rail
NTD2955-1G	IPAK (Pb-Free)	75 Units / Rail
NTD2955T4G	DPAK (Pb-Free)	2500 / Tape & Reel
NVD2955T4G*	DPAK (Pb-Free)	2500 / Tape & Reel
SVD2955T4G*	DPAK (Pb-Free)	2500 / Tape & Reel

[†]For information on tape and reel specifications, including part orientation and tape sizes, please refer to our Tape and Reel Packaging Specifications Brochure, BRD8011/D.

*NVD and SVD Prefix for Automotive and Other Applications Requiring Unique Site and Control Change Requirements; AEC-Q101 Qualified and PPAP Capable.

NTD2955, NVD2955

PACKAGE DIMENSIONS

DPAK (SINGLE GAUGE) CASE 369C ISSUE F

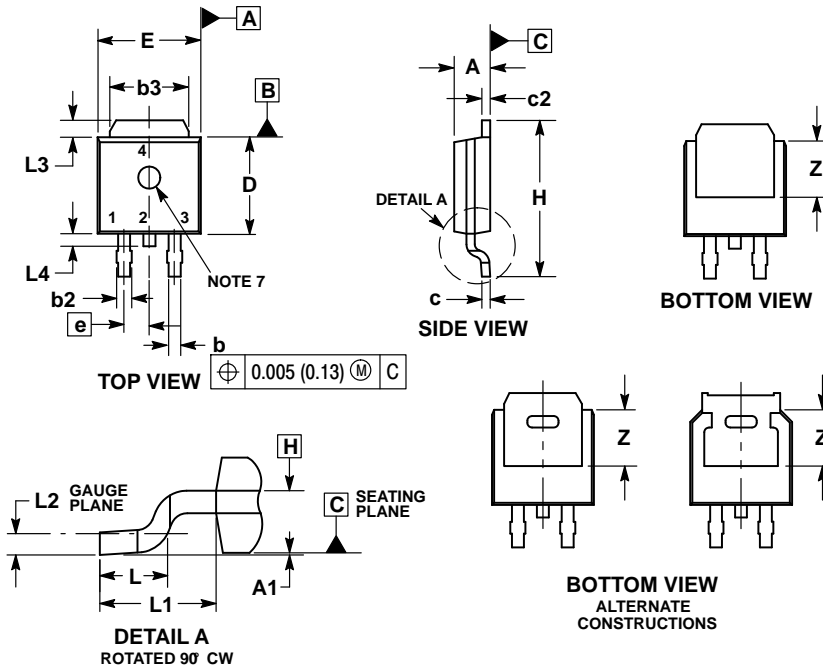

NOTES:

1. DIMENSIONING AND TOLERANCING PER ASME Y14.5M, 1994.
2. CONTROLLING DIMENSION: INCHES.
3. THERMAL PAD CONTOUR OPTIONAL WITHIN DIMENSIONS b3, L3 and Z.
4. DIMENSIONS D AND E DO NOT INCLUDE MOLD FLASH, PROTRUSIONS, OR BURRS. MOLD FLASH, PROTRUSIONS, OR GATE BURRS SHALL NOT EXCEED 0.006 INCHES PER SIDE.
5. DIMENSIONS D AND E ARE DETERMINED AT THE OUTERMOST EXTREMES OF THE PLASTIC BODY.
6. DATUMS A AND B ARE DETERMINED AT DATUM PLANE H.
7. OPTIONAL MOLD FEATURE.

DIM	INCHES		MILLIMETERS	
	MIN	MAX	MIN	MAX
A	0.086	0.094	2.18	2.38
A1	0.000	0.005	0.00	0.13
b	0.025	0.035	0.63	0.89
b2	0.028	0.045	0.72	1.14
b3	0.180	0.215	4.57	5.46
c	0.018	0.024	0.46	0.61
c2	0.018	0.024	0.46	0.61
D	0.235	0.245	5.97	6.22
E	0.250	0.265	6.35	6.73
e	0.090	BSC	2.29	BSC
H	0.370	0.410	9.40	10.41
L	0.055	0.070	1.40	1.78
L1	0.114	REF	2.90	REF
L2	0.020	BSC	0.51	BSC
L3	0.035	0.050	0.89	1.27
L4	---	0.040	---	1.01
Z	0.155	---	3.93	---

STYLE 2:

1. GATE
2. DRAIN
3. SOURCE
4. DRAIN

SOLDERING FOOTPRINT*

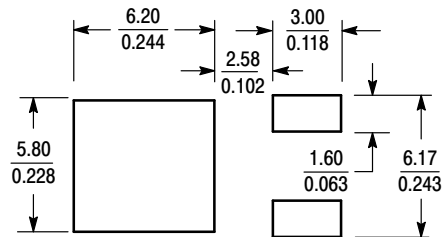

SCALE 3:1 $\left(\frac{\text{mm}}{\text{inches}}\right)$

*For additional information on our Pb-Free strategy and soldering details, please download the ON Semiconductor Soldering and Mounting Techniques Reference Manual, SOLDERRM/D.

NTD2955, NVD2955

PACKAGE DIMENSIONS

IPAK CASE 369D ISSUE C

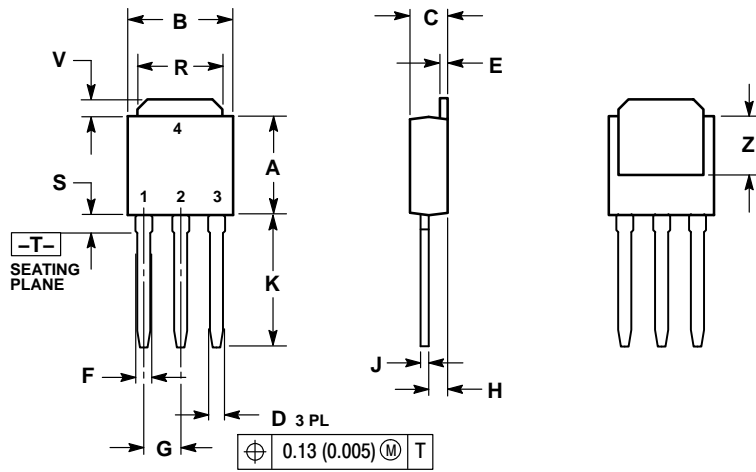

NOTES:

1. DIMENSIONING AND TOLERANCING PER ANSI Y14.5M, 1982.
2. CONTROLLING DIMENSION: INCH.

DIM	INCHES		MILLIMETERS	
	MIN	MAX	MIN	MAX
A	0.235	0.245	5.97	6.35
B	0.250	0.265	6.35	6.73
C	0.086	0.094	2.19	2.38
D	0.027	0.035	0.69	0.88
E	0.018	0.023	0.46	0.58
F	0.037	0.045	0.94	1.14
G	0.090	BSC	2.29	BSC
H	0.034	0.040	0.87	1.01
J	0.018	0.023	0.46	0.58
K	0.350	0.380	8.89	9.65
R	0.180	0.215	4.45	5.45
S	0.025	0.040	0.63	1.01
V	0.035	0.050	0.89	1.27
Z	0.155	---	3.93	---

STYLE 2:

- PIN 1. GATE
- 2. DRAIN
- 3. SOURCE
- 4. DRAIN

ON Semiconductor and are trademarks of Semiconductor Components Industries, LLC dba ON Semiconductor or its subsidiaries in the United States and/or other countries. ON Semiconductor owns the rights to a number of patents, trademarks, copyrights, trade secrets, and other intellectual property. A listing of ON Semiconductor's product/patent coverage may be accessed at www.onsemi.com/site/pdf/Patent-Marketing.pdf. ON Semiconductor reserves the right to make changes without further notice to any products herein. ON Semiconductor makes no warranty, representation or guarantee regarding the suitability of its products for any particular purpose, nor does ON Semiconductor assume any liability arising out of the application or use of any product or circuit, and specifically disclaims any and all liability, including without limitation special, consequential or incidental damages. Buyer is responsible for its products and applications using ON Semiconductor products, including compliance with all laws, regulations and safety requirements or standards, regardless of any support or applications information provided by ON Semiconductor. "Typical" parameters which may be provided in ON Semiconductor data sheets and/or specifications can and do vary in different applications and actual performance may vary over time. All operating parameters, including "Typicals" must be validated for each customer application by customer's technical experts. ON Semiconductor does not convey any license under its patent rights nor the rights of others. ON Semiconductor products are not designed, intended, or authorized for use as a critical component in life support systems or any FDA Class 3 medical devices or medical devices with a same or similar classification in a foreign jurisdiction or any devices intended for implantation in the human body. Should Buyer purchase or use ON Semiconductor products for any such unintended or unauthorized application, Buyer shall indemnify and hold ON Semiconductor and its officers, employees, subsidiaries, affiliates, and distributors harmless against all claims, costs, damages, and expenses, and reasonable attorney fees arising out of, directly or indirectly, any claim of personal injury or death associated with such unintended or unauthorized use, even if such claim alleges that ON Semiconductor was negligent regarding the design or manufacture of the part. ON Semiconductor is an Equal Opportunity/Affirmative Action Employer. This literature is subject to all applicable copyright laws and is not for resale in any manner.

PUBLICATION ORDERING INFORMATION

LITERATURE FULFILLMENT:

Literature Distribution Center for ON Semiconductor
 19521 E. 32nd Pkwy, Aurora, Colorado 80011 USA
Phone: 303-675-2175 or 800-344-3860 Toll Free USA/Canada
Fax: 303-675-2176 or 800-344-3867 Toll Free USA/Canada
Email: orderlit@onsemi.com

N. American Technical Support: 800-282-9855 Toll Free
 USA/Canada
Europe, Middle East and Africa Technical Support:
 Phone: 421 33 790 2910
Japan Customer Focus Center
 Phone: 81-3-5817-1050

ON Semiconductor Website: www.onsemi.com
Order Literature: <http://www.onsemi.com/orderlit>

For additional information, please contact your local Sales Representative

Mouser Electronics

Authorized Distributor

Click to View Pricing, Inventory, Delivery & Lifecycle Information:

[ON Semiconductor:](#)

[NVD2955T4G](#)