

LOC	DIST	REVISIONS			
P	LTR	DESCRIPTION	DATE	DWN	APVD
A		ECO-05-9575	27SEP05	MB	MS
A1		REVISED PER ECO-10-000444	19JAN10	KK	HMR

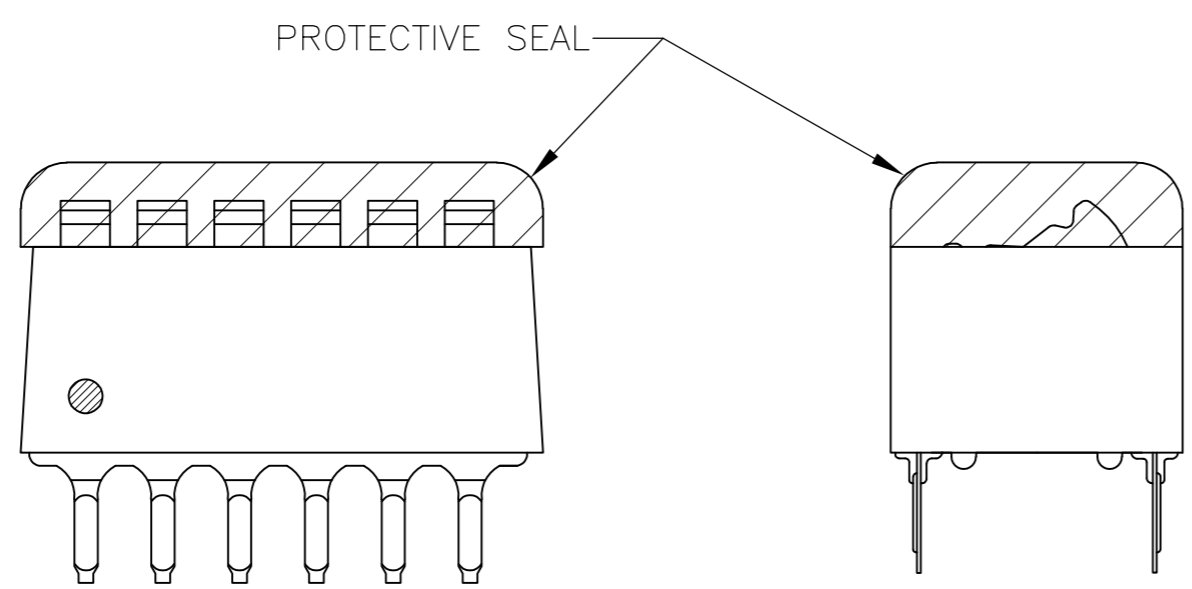
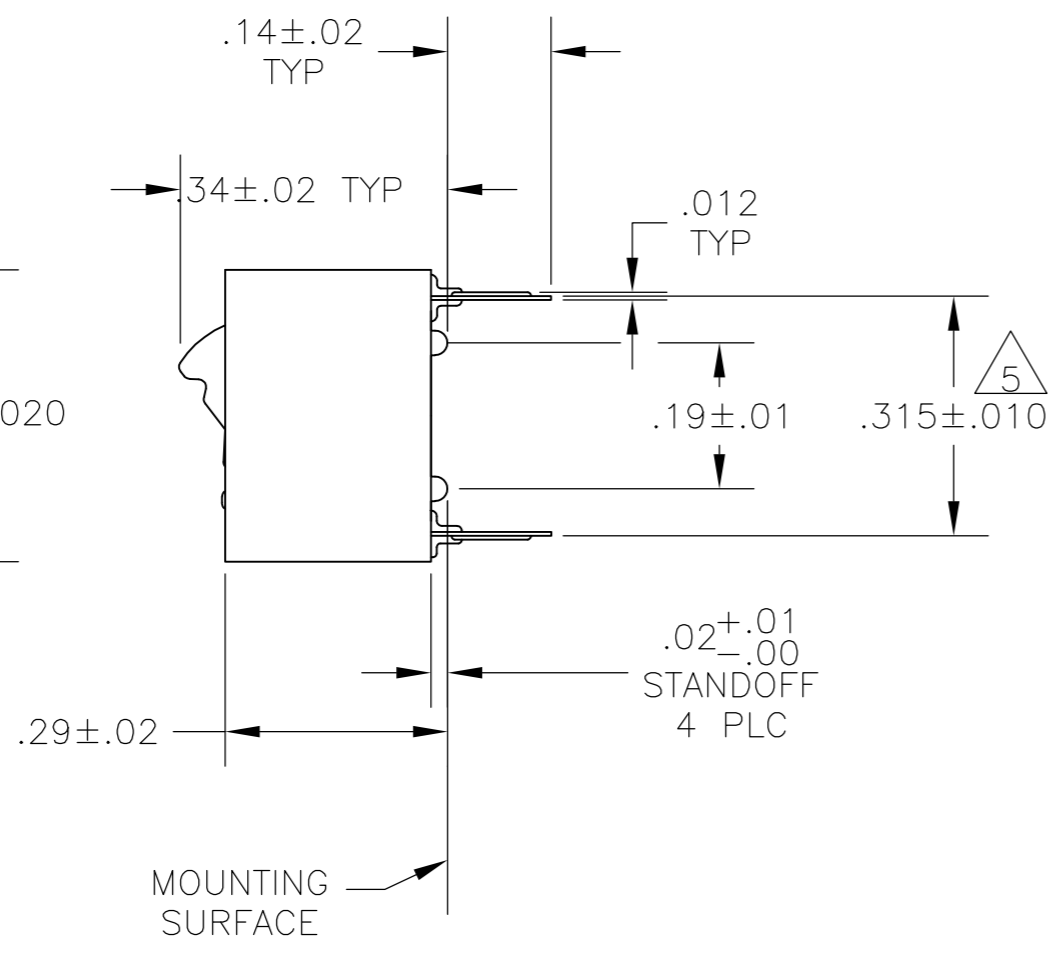
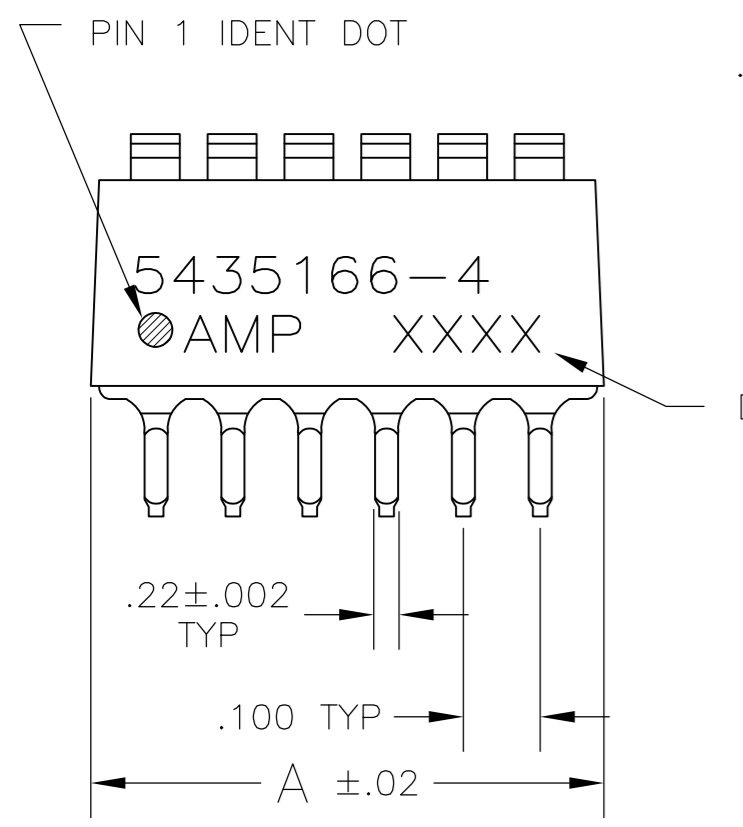
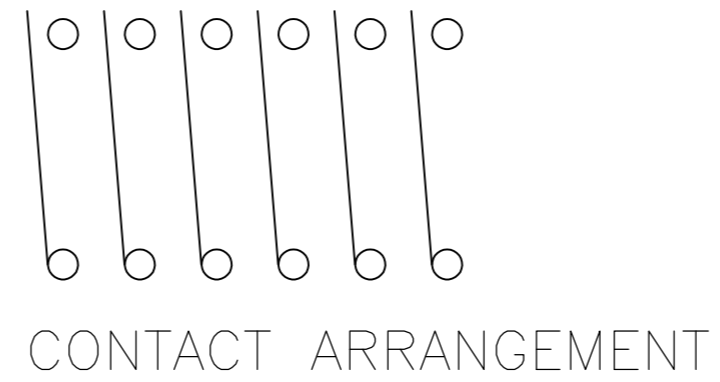
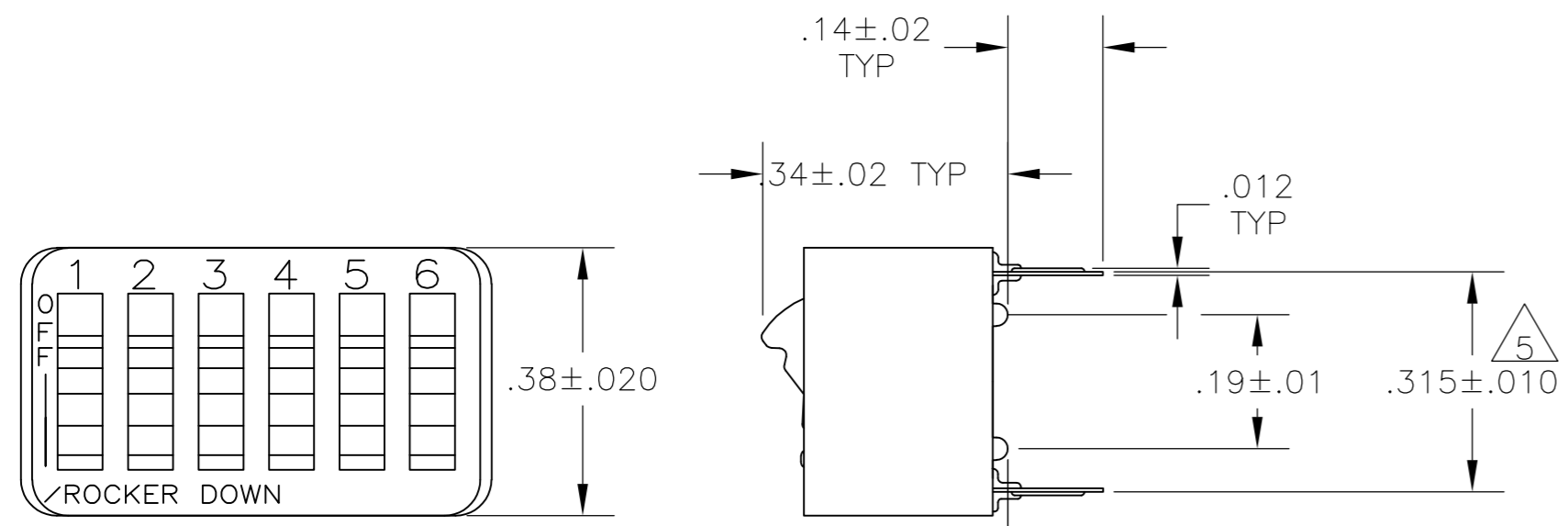

FIG 1

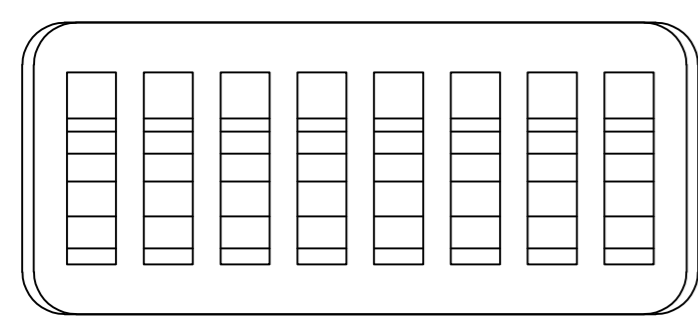

FIG 2

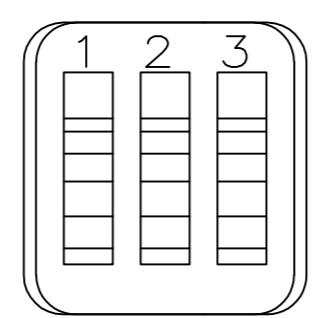

FIG 7

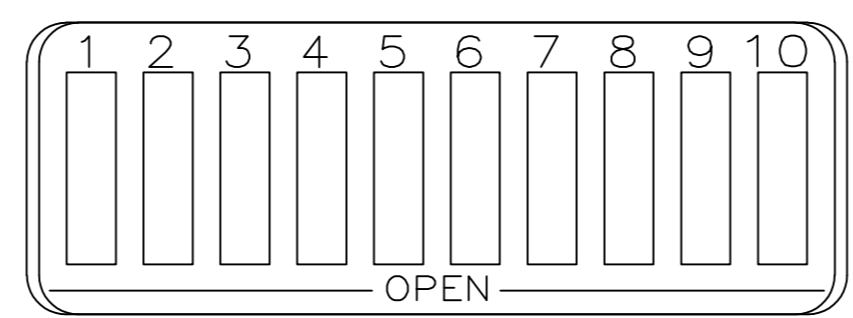

FIG 8

- FOR ADDITIONAL SPECIFICATIONS SEE AMP PRODUCT SPEC 108-7519.
- SWITCH SHOWN IN OPEN POSITION.
- ALL CHARACTERS AND ROCKERS ARE WHITE, HOUSING IS BLACK.
- STAMPING WILL VARY ON 2 AND 3 POSITION SIDES DUE TO SPACE RESTRICTIONS
- $\triangle 5$.315 DIMENSION APPLIES AT TERMINAL TIPS. TERMINALS ARE .300 +.010 AT MOUNTING SURFACE. -.000
- $\triangle 6$ STRIPPABLE TRANSPARENT SEAL, SEE FIG 1.
- ALL MATERIALS AND FINISHES SHALL COMPLY WITH EU DIRECTIVE 2002 /95/EC OF 27JAN2003 (ROHS).
- $\triangle 8$ HOUSING AND ROCKERS-POLYESTER
CONTACTS AND SOLDER LEADS-COPPER ALLOY
- $\triangle 9$ CONTACTS-GOLD OVER NICKEL
SOLDER LEADS-TIN OVER NICKEL
- $\triangle 10$ OBSOLETE PARTS: OBSOLETE CIS STREAMLINING PER D.RENAUD/D.SINISI

FIG	PROTECTIVE SEAL	NO OF POSN	PART NO	
$\triangle 10$ OBSOLETE	$\triangle 6$	1.08	10	7-5435166-4
		1.08	10	5-5435166-5
		.88	8	5-5435166-3
		.78	7	5-5435166-2
		.68	6	5-5435166-1
$\triangle 10$ OBSOLETE	$\triangle 6$.58	5	5-5435166-0
		.48	4	4-5435166-9
		.28	2	2-5435166-9
		.88	8	2-5435166-8
		.88	8	5435166-7
$\triangle 10$ OBSOLETE	AS SHOWN	.88	8	5435166-5
		.68	6	5435166-4
		.48	4	5435166-2
		.78	7	5435166-1
		.78	7	5435166-1

THIS DRAWING IS A CONTROLLED DOCUMENT.		DWN BSV 10JAN2005	Tyco Electronics Corporation Harrisburg, PA 17105-3608	
DIMENSIONS: INCHES	TOLERANCES UNLESS OTHERWISE SPECIFIED:	CHK -	NAME	
	0 PLC ± -	APVD -	SWITCH ASSY, DIP, TYPE C, 7000 SERIES, SPST, STANDARD	
	1 PLC ± -	PRODUCT SPEC -	SIZE A2	CAGE CODE 00779
	2 PLC ± -	APPLICATION SPEC -	DRAWING NO C=5435166	RESTRICTED TO -
	3 PLC ± .005	WEIGHT -	SCALE 4:1	SHEET 1 of 1
	4 PLC ± -	CUSTOMER DRAWING	REV A1	
	ANGLES ± -			
MATERIAL $\triangle 8$	FINISH $\triangle 9$			

Mouser Electronics

Authorized Distributor

Click to View Pricing, Inventory, Delivery & Lifecycle Information:

[TE Connectivity:](#)

[5-5435166-3](#)