



■ Features :

- Constant current design
- Universal AC input / Full range (up to 305VAC)
- Built-in active PFC function
- High efficiency up to 91%
- Protections: Short circuit / Over voltage / Over temperature
- Cooling by free air convection
- Output current adjustable through output cable or internal potentiometer
- IP67 / IP65 design for indoor or outdoor installations
- Three in one dimming function (1~10Vdc or 10V PWM signal or resistance)
- Suitable for dry / damp / wet locations



HLG-60H-C350  A : IP65 rated. Constant current level can be adjusted through internal potentiometer.  
 B : IP67 rated. Constant current level adjustable through output cable with 1~10Vdc or 10V PWM signal or resistance.  
 D (option) : IP67 rated. Timer dimming function, contact MEAN WELL for details.

**SPECIFICATION**

MODEL	HLG-60H-C350 <input type="checkbox"/>	HLG-60H-C700 <input type="checkbox"/>	
OUTPUT	RATED CURRENT	350mA	700mA
	CURRENT ACCURACY	±5.0%	
	CONSTANT CURRENT REGION <small>Note.6</small>	100 ~ 200V	50 ~ 100V
	RATED POWER	70W	
	RIPPLE CURRENT	±5%	
	RIPPLE & NOISE <small>Note.7</small>	1V	0.5V
	CURRENT ADJ. RANGE	Can be adjusted by internal potentiometer or through output cable 210 ~ 350mA	
	SETUP, RISE TIME	1500ms, 80ms / 115VAC at full load    1000ms, 80ms / 230VAC at full load	
HOLD UP TIME (Typ.)	16ms at full load    230VAC / 115VAC		
INPUT	VOLTAGE RANGE <small>Note.2</small>	90 ~ 305VAC	127VDC ~ 431VDC
	FREQUENCY RANGE	47 ~ 63Hz	
	POWER FACTOR (Typ.)	PF>0.98/115VAC, PF>0.96/230VAC, PF>0.94/277VAC at full load (Please refer to "Power Factor Characteristic" curve)	
	EFFICIENCY (Typ.)	91%	91%
	AC CURRENT (Typ.)	0.69A / 115VAC	0.35A / 230VAC    0.29A / 277VAC
	INRUSH CURRENT (Typ.)	COLD START 70A / 230VAC	
	LEAKAGE CURRENT	<0.75mA / 277VAC	
PROTECTION	SHORT CIRCUIT	Hiccup mode, recovers automatically after fault condition is removed	
	OVER VOLTAGE	230 ~ 250V	120 ~ 140V
	OVER TEMPERATURE	85°C ±10°C (RTH2) Protection type : Shut down o/p voltage, re-power on to recover	
ENVIRONMENT	WORKING TEMP.	-40 ~ +70°C (Refer to "Derating Curve")	
	WORKING HUMIDITY	10 ~ 95% RH non-condensing	
	STORAGE TEMP., HUMIDITY	-40 ~ +80°C, 10 ~ 95% RH	
	TEMP. COEFFICIENT	±0.03%/°C (0 ~ 50°C)	
	VIBRATION	10 ~ 500Hz, 5G 12min./1cycle, period for 72min. each along X, Y, Z axes	
SAFETY & EMC	SAFETY STANDARDS <small>Note.3</small>	UL8750, CSA C22.2 No. 250.0-08, EN61347-1, EN61347-2-13 independent, IP65 or IP67 approved	
	WITHSTAND VOLTAGE	I/P-O/P:3.75KVAC    I/P-FG:2KVAC    O/P-FG:0.5KVAC	
	ISOLATION RESISTANCE	I/P-O/P, I/P-FG, O/P-FG:100M Ohms / 500VDC / 25°C / 70% RH	
	EMC EMISSION	Compliance to EN55015, EN61000-3-2 Class C (≥60% load) ; EN61000-3-3	
OTHERS	EMC IMMUNITY	Compliance to EN61000-4-2,3,4,5,6,8,11, EN61547, heavy industry level (surge L,N-FG: 4KV), criteria A	
	MTBF	338K hrs min.    MIL-HDBK-217F (25°C)	
	DIMENSION	171*61.5*36.8 mm (L*W*H)	
NOTE	PACKING	0.73Kg; 20pcs/15.6Kg/0.8CUFT	
	<ol style="list-style-type: none"> <li>1. All parameters NOT specially mentioned are measured at 230VAC input, rated load and 25°C of ambient temperature.</li> <li>2. Derating may be needed under low input voltages. Please check the static characteristics for more details.</li> <li>3. Safety and EMC design refer to EN60598-1, CNS15233, GB7000.1.</li> <li>4. The power supply is considered as a component that will be operated in combination with final equipment. Since EMC performance will be affected by the complete installation, the final equipment manufacturers must re-qualify EMC Directive on the complete installation again.</li> <li>5. Refer to warranty statement.</li> <li>6. Constant current operation region is within 50% ~100% rated output voltage. This is the suitable operation region for LED related applications, but please reconfirm special electrical requirements for some specific system design.</li> <li>7. Ripple &amp; noise are measured at 20MHz of bandwidth by using a 12" twisted pair-wire terminated with a 0.1uf &amp; 2.2uf parallel capacitor.</li> </ol>		

**Mechanical Specification**

Case No.957 Unit:mm

**A Type:(HLG-60H-C\_A)**

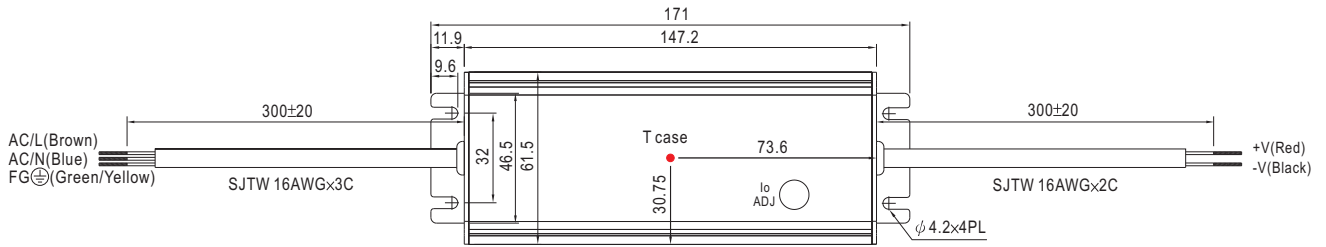

※ T case: Max. Case Temperature.

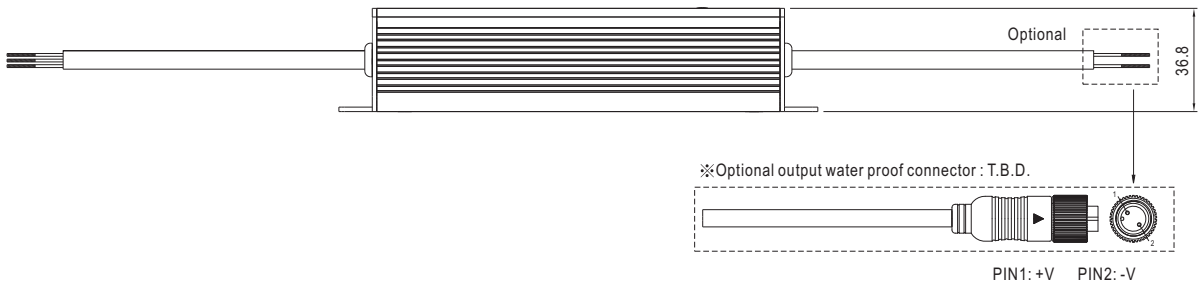

※ IP65 rated. Constant current level can be adjusted through internal potentiometer.  
(Can access by removing the rubber stopper on the case.)

**B Type:(HLG-60H-C\_B)**

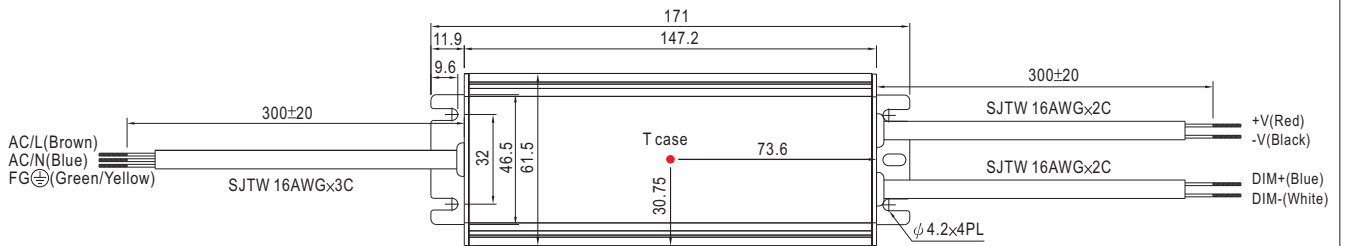

※ T case: Max. Case Temperature.

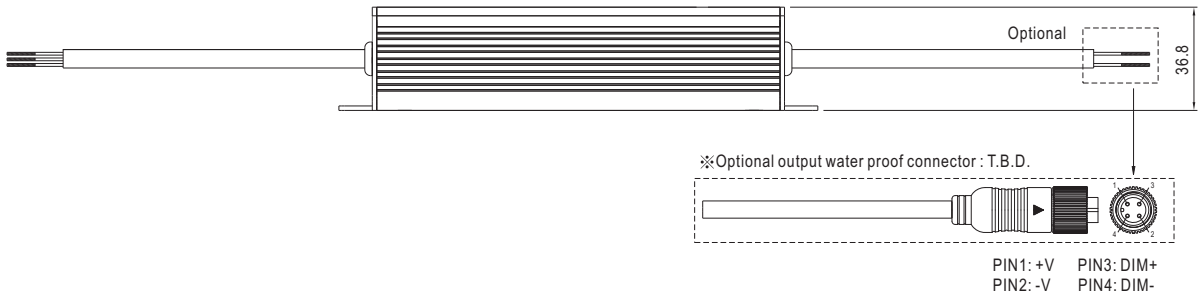

**D Type:(HLG-60H-C\_D)**

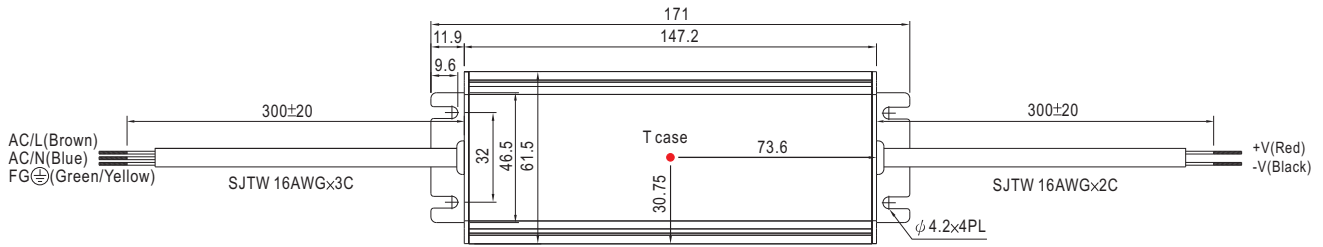

※ T case: Max. Case Temperature.

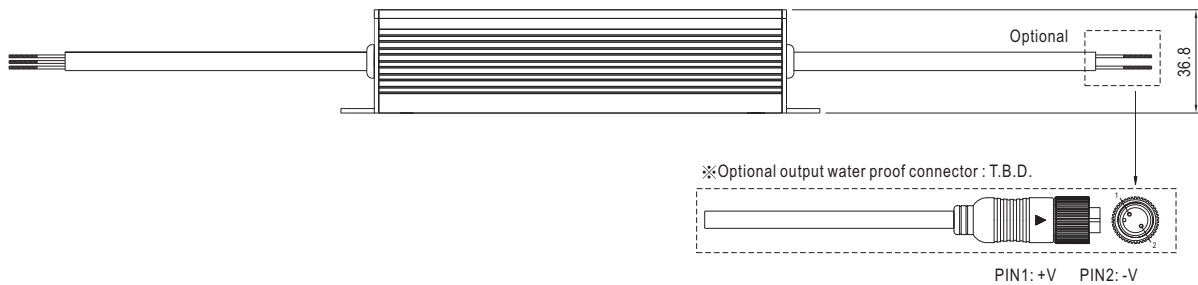

※ IP67 rated. Timer dimming function, contact MEAN WELL for details.

**Block Diagram**

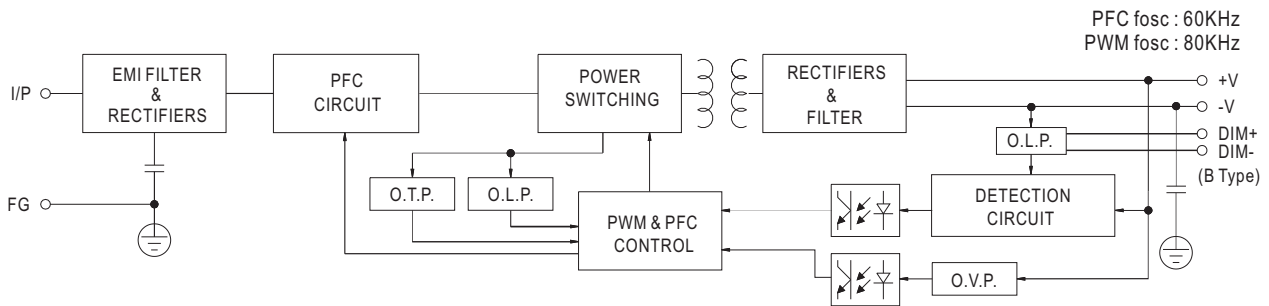

**Derating Curve**

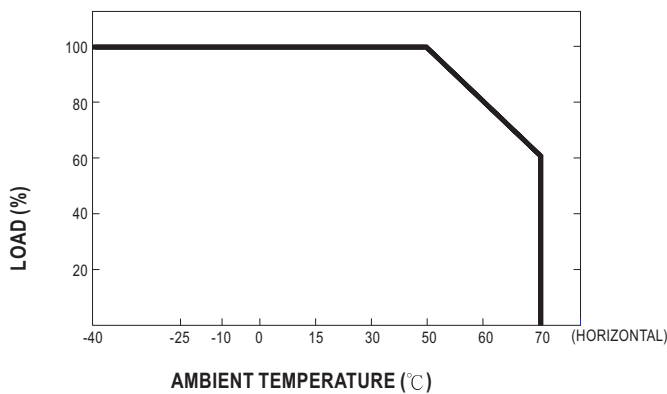

**Static Characteristics**

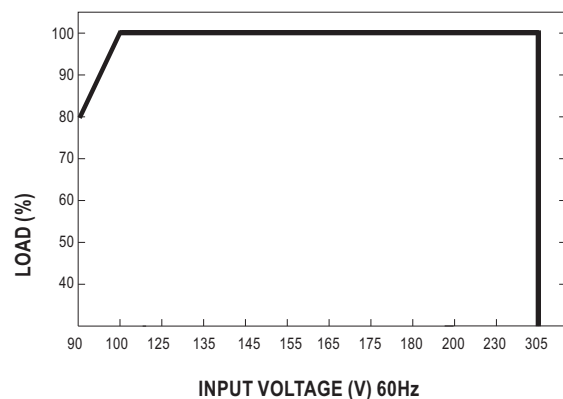

### Power Factor Characteristic

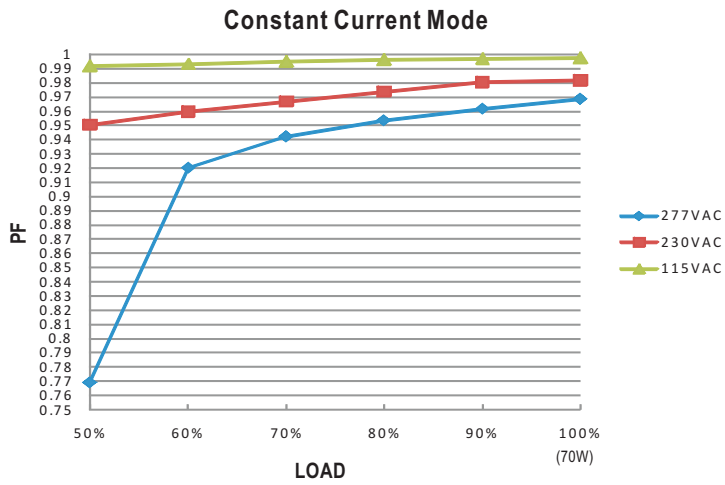

### EFFICIENCY vs LOAD (HLG-60H-C700A Model)

HLG-60H-C series possess superior working efficiency that up to 91% can be reached in field applications.

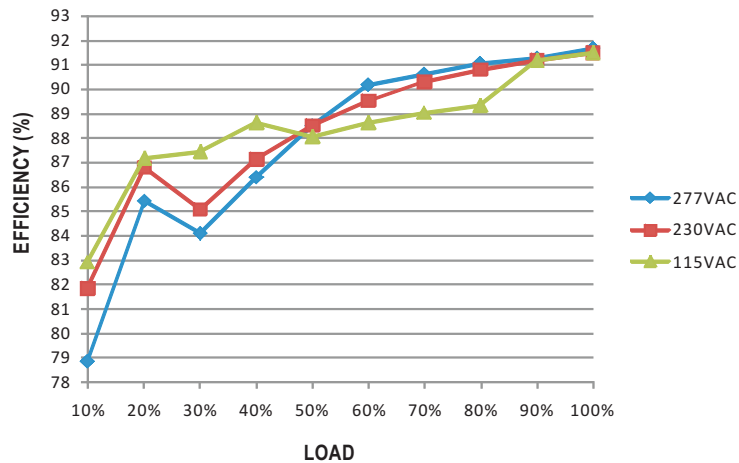

### DRIVING METHODS OF LED MODULE

A typical LED power supply may work in "constant current mode (CC)" to drive the LEDs.  
 Mean Well's LED power supply with CC characteristic can be operated at CC mode (direct drive, at area (A)).

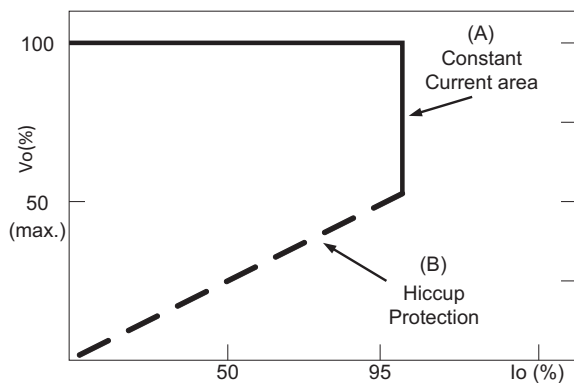

Typical LED power supply I-V curve

## DIMMING OPERATION

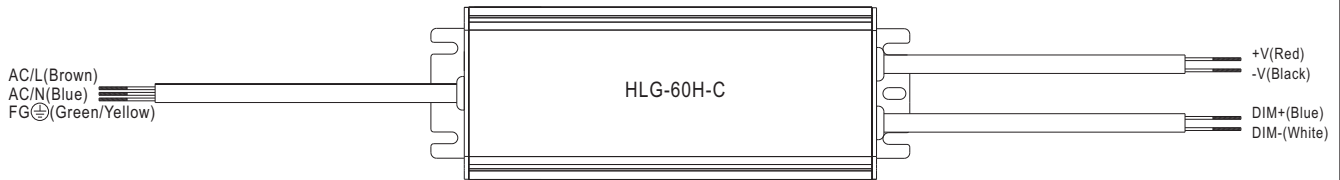

※ Built-in 3 in 1 dimming function, IP67 rated. Output constant current level can be adjusted through output cable by connecting a resistance or 1 ~ 10Vdc or 10V PWM signal between DIM+ and DIM-.

※ Please DO NOT connect "DIM-" to "-V".

※ Reference resistance value for output current adjustment (Typical)

Resistance value	Single driver	10KΩ	20KΩ	30KΩ	40KΩ	50KΩ	60KΩ	70KΩ	80KΩ	90KΩ	100KΩ	OPEN
	Multiple drivers (N=driver quantity for synchronized dimming operation)	10KΩ/N	20KΩ/N	30KΩ/N	40KΩ/N	50KΩ/N	60KΩ/N	70KΩ/N	80KΩ/N	90KΩ/N	100KΩ/N	-----
Percentage of rated current		10%	20%	30%	40%	50%	60%	70%	80%	90%	100%	95%~105%

※ 1 ~ 10V dimming function for output current adjustment (Typical)

Dimming value	1V	2V	3V	4V	5V	6V	7V	8V	9V	10V	OPEN
Percentage of rated current	10%	20%	30%	40%	50%	60%	70%	80%	90%	100%	95%~105%

※ 10V PWM signal for output current adjustment (Typical): Frequency range : 100Hz ~ 3KHz

Duty value	10%	20%	30%	40%	50%	60%	70%	80%	90%	100%	OPEN
Percentage of rated current	10%	20%	30%	40%	50%	60%	70%	80%	90%	100%	95%~105%

※ Using the built-in dimming function on B-type model can't turn the lighting fixture totally dark. Please refer to the connection method below to achieve 0% brightness of the lighting fixture connecting to the LED power supply unit.

※ Direct connecting to LEDs is suggested, but is not suitable for using additional drivers.

Dimming connection diagram for turning the lighting fixture ON/OFF :

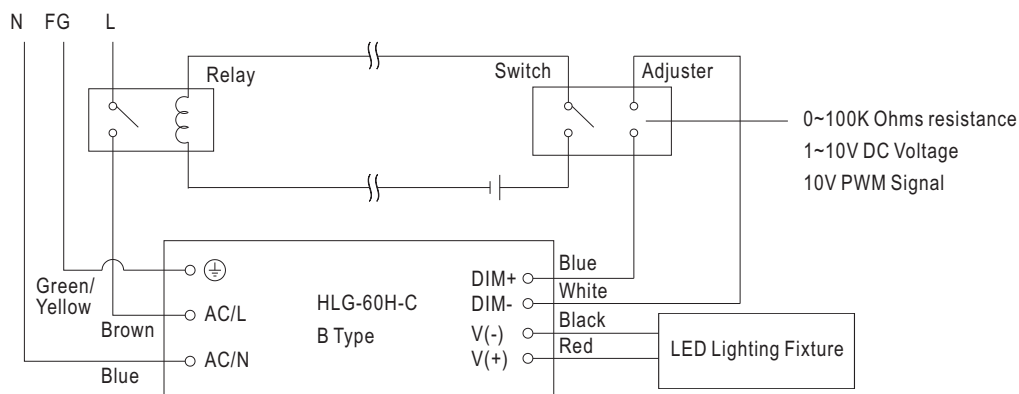

Using a switch and relay can turn ON/OFF the lighting fixture.

1. Output constant current level can be adjusted through output cable by connecting a resistance or 1~10Vdc or 10V PWM signal between DIM+ and DIM-.
2. The LED lighting fixture can be turned ON/OFF by the switch.

## WATERPROOF CONNECTION

### Waterproof connector

Waterproof connector can be assembled on the output cable of HLG-60H-C to operate in dry/wet/damp or outdoor environment.

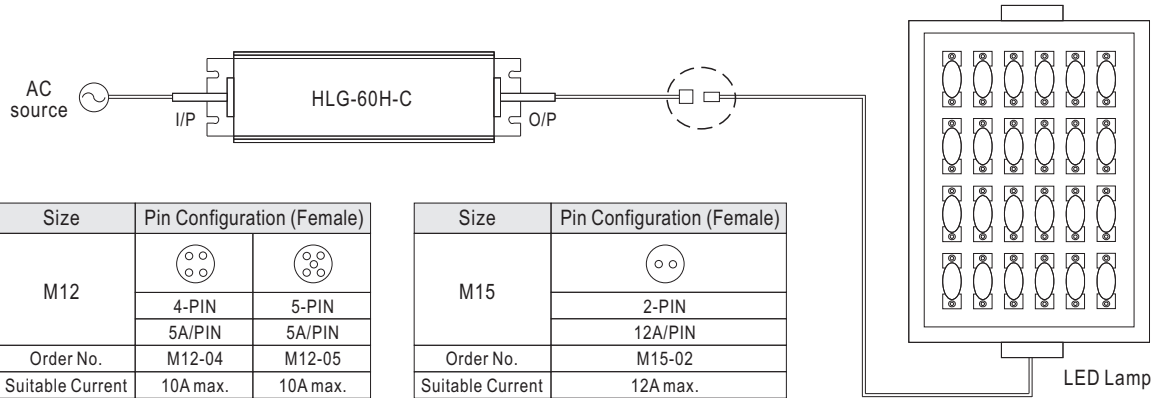

### Cable Joiner

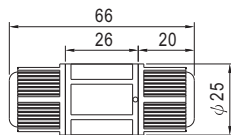

CJ04-1 suitable for 14AWG~16AWG  
 CJ04-2 suitable for 18AWG~22AWG



Up to four wires can be connected through this cable joiner by soldering or clamping by tools.

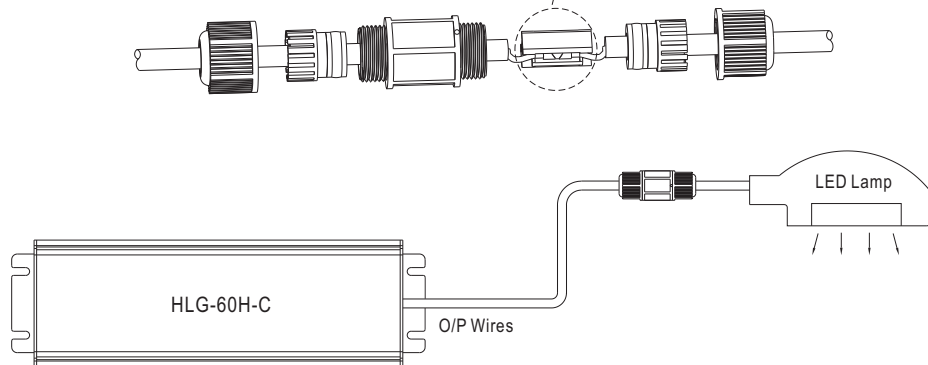

※CJ04 cable joiner can be purchased independently for user's own assembly.  
 MEAN WELL order No. : CJ04-1, CJ04-2.

# Mouser Electronics

Authorized Distributor

Click to View Pricing, Inventory, Delivery & Lifecycle Information:

[MEAN WELL:](#)

[HLG-60H-C350A](#) [HLG-60H-C350B](#) [HLG-60H-C700A](#) [HLG-60H-C700B](#)