

ITEM	QTY	PART NUMBER	PART DESCRIPTION
1	1	NTM-XXX	Molded, Self-Retaining LED Mount
2	1	3XX-S	T-1 (3mm) N-Flange LED, See page 2 & 3

REV.	DESCRIPTION	DATE	APPROVED
A	Engineering Release	07/17/06	M. C.
B	Removed Spacer Material Specs	06/29/07	M. C.
C	Updated LED Part No. to 3XX-S in BOM	12/19/12	T. Y.
D	Removed LTM from Spec & Added Page 3	06/25/16	J. C.

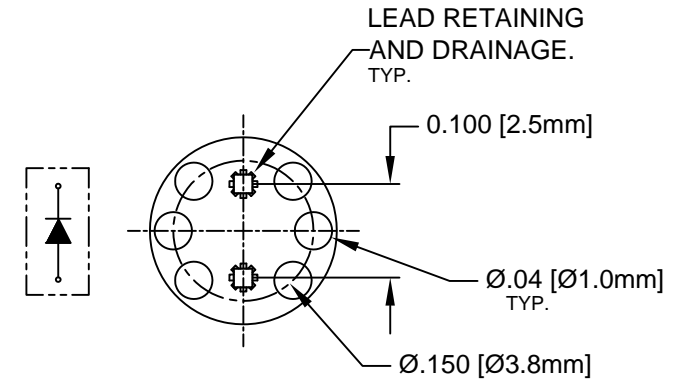
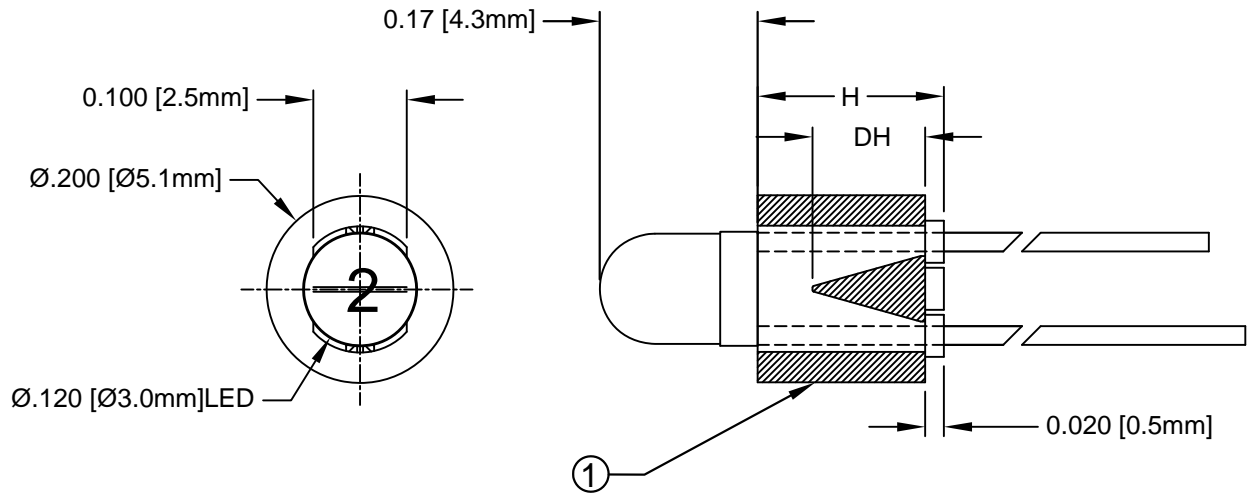

PART NO.	H	DH
NTM-120	.120(3.1)	.060(1.5)
NTM-130	.130(3.3)	
NTM-140	.140(3.6)	
NTM-150	.150(3.8)	
NTM-160	.160(4.1)	
NTM-170	.170(4.3)	
NTM-180	.180(4.6)	
NTM-190	.190(4.8)	
NTM-200	.200(5.1)	
NTM-210	.210(5.3)	
NTM-220	.220(5.6)	
NTM-230	.230(5.8)	
NTM-240	.240(6.1)	
NTM-250	.250(6.4)	
NTM-260	.260(6.6)	
NTM-270	.270(6.9)	
NTM-280	.280(7.1)	
NTM-290	.290(7.4)	

PART NO.	H	DH
NTM-300	.300(7.6)	.185(4.7)
NTM-310	.310(7.9)	
NTM-320	.320(8.1)	
NTM-330	.330(8.4)	
NTM-340	.340(8.6)	
NTM-350	.350(8.9)	
NTM-360	.360(9.1)	
NTM-370	.370(9.4)	
NTM-380	.380(9.7)	
NTM-390	.390(9.9)	
NTM-400	.400(10.2)	
NTM-410	.410(10.4)	
NTM-420	.420(10.7)	
NTM-430	.430(10.9)	
NTM-440	.440(11.2)	
NTM-450	.450(11.4)	
NTM-460	.460(11.7)	
NTM-480	.480(12.2)	

PART NO.	H	DH
NTM-490	.490(12.5)	.310(7.9)
NTM-500	.500(12.7)	.435(11.1)
NTM-520	.520(13.2)	
NTM-550	.550(14.0)	
NTM-570	.570(14.5)	
NTM-600	.600(15.2)	
NTM-620	.620(15.8)	
NTM-650	.650(16.5)	
NTM-670	.670(17.0)	
NTM-700	.700(17.8)	
NTM-720	.720(18.3)	
NTM-750	.750(19.1)	
NTM-770	.770(19.6)	
NTM-800	.800(20.3)	
NTM-820	.820(20.8)	
NTM-850	.850(21.6)	
NTM-870	.870(22.1)	
NTM-900	.900(22.9)	

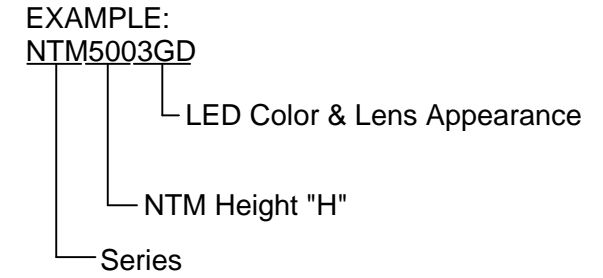
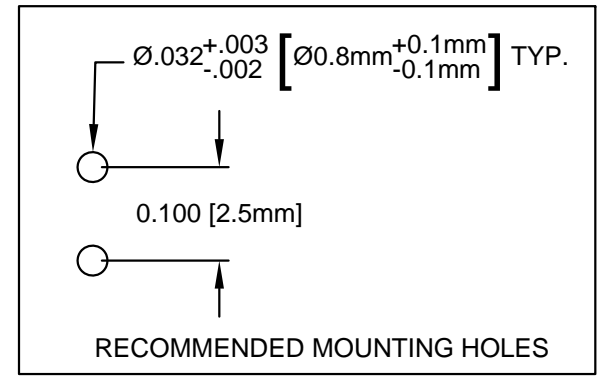

ABSOLUTE MAXIMUM RATINGS (Ta=25° C)

REVERSE VOLTAGE _____	5V
REVERSE CURRENT _____	100uA
OPERATING TEMPERATURE RANGE _____	-25° C - 85° C
STORAGE TEMPERATURE _____	-30° C - 100° C
LEAD SOLDERING TEMPERATURE(1/16" FROM BODY) _____	260° C FOR 5 SECONDS

STANDARD TOLERANCE (UNLESS OTHERWISE SPECIFIED)		 4 THOMAS, IRVINE, CA. 92618 TEL: (949) 951-8808 FAX: (949) 951-3974	
DECIMALS	ANGULAR		
.X ± .1	X° ± 1°	 TITLE: MOLDED, SELF-RETAINING T1 (3mm) LED MOUNT ASSEMBLY	
.XX ± .02			
.XXX ± .010		PART NO: NTMXXX3XX REVISION: D	
DESIGNED: S. Dam	DATE: 07/17/06	CAGE CODE : 32559 SHEET # 1 OF 3	
CHECKED: T. Yin	DATE: 07/17/06	CAD GENERATED DOCUMENT. DO NOT MEASURE DRAWING.	

REV.	DESCRIPTION	DATE	APPROVED
	SEE SHEET #1		



LED Assy. No.	Chip			Lens Appearance	Electro-Optical Data			Viewing Angle 2 θ ½ (Deg)	LED P/N
	Material	Peak Wave Length λp(nm)	Emitted Color		Vf (V)		Iv (mcd)		
					TYP	MAX	TYP		
STANDARD					Data @ 20mA				
NTMXXX3BWC	GaN/SiC	430	BLUE	WATER CLEAR	4.0	4.5	25	30	3BWC-S
NTMXXX3BWD	GaN/SiC	430	BLUE	DIFFUSED	4.0	4.5	10	40	3BWD-S
NTMXXX3BWT	GaN/SiC	430	BLUE	TINTED	4.0	4.5	25	30	3BWT-S
NTMXXX3PGC	GaP/GaP	555	PURE GREEN	WATER CLEAR	2.2	2.8	10	30	3PGC-S
NTMXXX3PGD	GaP/GaP	555	PURE GREEN	DIFFUSED	2.2	2.8	5	40	3PGD-S
NTMXXX3PGT	GaP/GaP	555	PURE GREEN	TINTED	2.2	2.8	10	30	3PGT-S
NTMXXX3GC	GaP/GaP	568	GREEN	WATER CLEAR	2.1	2.8	40	30	3GC-S
NTMXXX3GD	GaP/GaP	568	GREEN	DIFFUSED	2.1	2.8	25	40	3GD-S
NTMXXX3GT	GaP/GaP	568	GREEN	TINTED	2.1	2.8	40	30	3GT-S
NTMXXX3SGC	GaP/GaP	568	SUPER GREEN	WATER CLEAR	2.1	2.8	50	30	3SGC-S
NTMXXX3SGD	GaP/GaP	568	SUPER GREEN	DIFFUSED	2.1	2.8	30	40	3SGD-S
NTMXXX3SGT	GaP/GaP	568	SUPER GREEN	TINTED	2.1	2.8	50	30	3SGT-S
NTMXXX3YC	GaAsP/GaP	590	YELLOW	WATER CLEAR	2.0	2.8	40	30	3YC-S
NTMXXX3YD	GaAsP/GaP	590	YELLOW	DIFFUSED	2.0	2.8	20	40	3YD-S
NTMXXX3YT	GaAsP/GaP	590	YELLOW	TINTED	2.0	2.8	40	30	3YT-S
NTMXXX3AC	GaAsP/GaP	605	AMBER	WATER CLEAR	2.0	2.8	40	30	3AC-S
NTMXXX3AD	GaAsP/GaP	605	AMBER	DIFFUSED	2.0	2.8	25	40	3AD-S
NTMXXX3AT	GaAsP/GaP	605	AMBER	TINTED	2.0	2.8	40	30	3AT-S
NTMXXX3SAC	AlGaInP	605	SUPER AMBER	WATER CLEAR	1.8	2.4	300	30	3SAC-S
NTMXXX3SAD	AlGaInP	605	SUPER AMBER	DIFFUSED	1.8	2.4	100	40	3SAD-S
NTMXXX3SAT	AlGaInP	605	SUPER AMBER	TINTED	1.8	2.4	300	30	3SAT-S
NTMXXX3HC	GaAsP/GaP	625	HE RED	WATER CLEAR	2.0	2.8	50	30	3HC-S
NTMXXX3HD	GaAsP/GaP	625	HE RED	DIFFUSED	2.0	2.8	30	40	3HD-S
NTMXXX3HT	GaAsP/GaP	625	HE RED	TINTED	2.0	2.8	50	30	3HT-S
NTMXXX3RC	GaP/GaP	700	RED	WATER CLEAR	2.1	2.8	2.5	30	3RC-S
NTMXXX3RD	GaP/GaP	700	RED	DIFFUSED	2.1	2.8	2	40	3RD-S
NTMXXX3RT	GaP/GaP	700	RED	TINTED	2.1	2.8	2.5	30	3RT-S
NTMXXX3SRC	GaAlAs/GaAs	645	SUPER RED	WATER CLEAR	1.7	2.4	60	30	3SRC-S
NTMXXX3SRD	GaAlAs/GaAs	645	SUPER RED	DIFFUSED	1.7	2.4	40	40	3SRD-S
NTMXXX3SRT	GaAlAs/GaAs	645	SUPER RED	TINTED	1.7	2.4	60	30	3SRT-S

STANDARD TOLERANCE (UNLESS OTHERWISE SPECIFIED) 10% All Values ANGULAR		 BIVAR ® 4 THOMAS, IRVINE, CA. 92618 TEL: (949) 951-8808 FAX: (949) 951-3974	
DESIGNED: S. Dam			
CHECKED: T. Yin		DATE: 07/17/06	PART NO: NTMXXX3XX REVISION: D
		CAGE CODE : 32559	SHEET # 2 OF 3
CAD GENERATED DOCUMENT. DO NOT MEASURE DRAWING.			

REV.	DESCRIPTION	DATE	APPROVED
	SEE SHEET #1		

LED Assy. No.	Chip			Lens Appearance	Electro-Optical Data			Viewing Angle 2 θ ½ (Deg)	LED P/N
	Material	Peak Wave Length λp(nm)	Emitted Color		Vf (V)		Iv (mcd)		
					TYP	MAX	TYP		
LOW CURRENT					Data @ 2mA				
NTMXXXBWDL	GaN/siC	430	BLUE	DIFFUSED	3.8	4.2	2.5	40	3BWDL-S
NTMXXXGDL	GaP/GaP	568	GREEN	DIFFUSED	2.1	2.6	2	40	3GDL-S
NTMXXXGTL	GaP/GaP	568	GREEN	TINTED	1.8	2.2	7.5	30	3GTL-S
NTMXXXPGDL	GaP/GaP	555	PURE GREEN	DIFFUSED	2.1	2.6	0.2	40	3PGDL-S
NTMXXXYDL	GaAsP/GaP	590	YELLOW	DIFFUSED	2.0	2.6	2	40	3YDL-S
NTMXXXADL	GaAsP/GaP	605	AMBER	DIFFUSED	2.0	2.6	4	40	3ADL-S
NTMXXXHDL	GaAsP/GaP	625	HE RED	DIFFUSED	2.0	2.6	2.5	40	3HDL-S
NTMXXXHTL	GaAsP/GaP	635	HE RED	TINTED	1.8	2.2	6.5	30	3HTL-S
NTMXXXRDL	GaP/GaP	700	RED	DIFFUSED	2.1	2.6	0.5	40	3RDL-S

LED Assy. No.	Chip			Lens Appearance	Electro-Optical Data			Viewing Angle 2 θ ½ (Deg)	LED P/N
	Material	Peak Wave Length λp(nm)	Emitted Color		Vf (V)		Iv (mcd)		
					TYP	MAX	TYP		
5 VOLT					Data @ 5V				
NTMXXX3GC5V	GaP/GaP	568	GREEN	WATER CLEAR	/	5.0	40	30	3GC5V-S
NTMXXX3GD5V	GaP/GaP	568	GREEN	DIFFUSED	/	5.0	25	40	3GD5V-S
NTMXXX3GT5V	GaP/GaP	568	GREEN	TINTED	/	5.0	40	30	3GT5V-S
NTMXXX3YD5V	GaAsP/GaP	590	YELLOW	DIFFUSED	/	5.0	20	40	3YD5V-S
NTMXXX3AD5V	GaAsP/GaP	605	AMBER	DIFFUSED	/	5.0	25	40	3AD5V-S
NTMXXX3HD5V	GaAsP/GaP	625	HE RED	DIFFUSED	/	5.0	30	40	3HD5V-S
NTMXXX3RD5V	GaP/GaP	700	RED	DIFFUSED	/	5.0	2	40	3RD5V-S

STANDARD TOLERANCE (UNLESS OTHERWISE SPECIFIED) 10% All Values ANGULAR		 4 THOMAS, IRVINE, CA. 92618 TEL: (949) 951-8808 FAX: (949) 951-3974	
		 TITLE: MOLDED, SELF-RETAINING T1 (3mm) LED MOUNT ASSEMBLY	
DESIGNED: S. Dam	DATE: 07/17/06	PART NO: NTMXXX3XX	REVISION: D
CHECKED: T. Yin	DATE: 07/17/06	CAGE CODE : 32559	SHEET # 3 OF 3
CAD GENERATED DOCUMENT. DO NOT MEASURE DRAWING.			

Mouser Electronics

Authorized Distributor

Click to View Pricing, Inventory, Delivery & Lifecycle Information:

[BIVAR:](#)

[NTM1603HD](#) [NTM2003GD](#) [NTM2603GD](#) [NTM2603HD](#) [NTM3003GD](#) [NTM3003HD](#) [NTM3003YD](#) [NTM3703GD](#)
[NTM3703YD](#) [NTM4403GD](#) [NTM4403YD](#) [NTM5203GD](#) [NTM5203HD](#) [NTM5203YD](#)