

LOC A1	DIST —	REVISIONS					
		P	LTR	DESCRIPTION	DATE	DWN	APVD
ÄNDERUNGEN, DIE DEM TECHNISCHEN FORTSCHRITT DIENEN, BEHALTEN WIR UNS VOR		P		REVISED PER ECO-11-005301	02MAR11	RK	HMR

RELEASED FOR PUBLICATION

ALL RIGHTS RESERVED.

SIEHE ZEICHNUNG
826 629 BLATT 2

VON DIESER ZEICHNUNG GIBT ES KEIN ORIGINAL

THIS DRAWING IS UNPUBLISHED.

By —
COPYRIGHT —

BESTELL-NR.	WERKSTOFF	OBERFLÄCHE FARBE

DIMENSIONS: mm	DWN	—	MATERIAL	—	FINISH	—
	CHK	—	 TE Connectivity			
TOLERANCES UNLESS OTHERWISE SPECIFIED:	APVD	—				
0 PLC ± -	PRODUCT SPEC	—	NAME AMPMODU II STIFTLAISTE ZWEIREIHIG			
1 PLC ± -	APPLICATION SPEC	—	SIZE	CAGE CODE	DRAWING NO	RESTRICTED TO
2 PLC ± -			A4	00779	C-826925	—
3 PLC ± -	WEIGHT	—	CUSTOMER DRAWING			
4 PLC ± -			SCALE	—	SHEET 1 OF 1	REV P
ANGLES ± -						

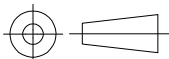

Mouser Electronics

Authorized Distributor

Click to View Pricing, Inventory, Delivery & Lifecycle Information:

[TE Connectivity:](#)

[826925-5](#)