

# NTMFD4902NF

## Dual N-Channel Power MOSFET with Integrated Schottky

30 V, High Side 18 A / Low Side 23 A, Dual N-Channel SO8FL



ON Semiconductor®

[www.onsemi.com](http://www.onsemi.com)

### Features

- Co-Packaged Power Stage Solution to Minimize Board Space
- Low Side MOSFET with Integrated Schottky
- Minimized Parasitic Inductances
- Optimized Devices to Reduce Power Losses
- These Devices are Pb-Free, Halogen Free/BFR Free and are RoHS Compliant

### Applications

- DC-DC Converters
- System Voltage Rails
- Point of Load

$V_{(BR)DSS}$	$R_{DS(ON) MAX}$	$I_D MAX$
Q1 Top FET 30 V	6.5 m $\Omega$ @ 10 V	18 A
	10 m $\Omega$ @ 4.5 V	
Q2 Bottom FET 30 V	4.1 m $\Omega$ @ 10 V	23 A
	6.2 m $\Omega$ @ 4.5 V	

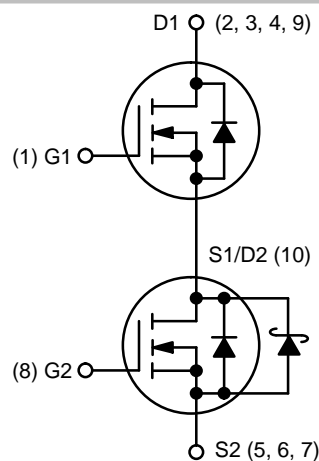

### PIN CONNECTIONS

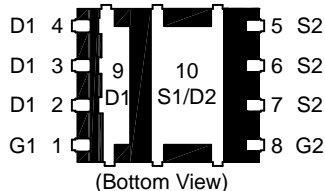

### MARKING DIAGRAM



4902NF = Specific Device Code  
 A = Assembly Location  
 Y = Year  
 W = Work Week  
 ZZ = Lot Traceability

### ORDERING INFORMATION

See detailed ordering and shipping information in the package dimensions section on page 5 of this data sheet.

# NTMFD4902NF

## MAXIMUM RATINGS ( $T_J = 25^\circ\text{C}$ unless otherwise stated)

Parameter			Symbol	Value	Unit		
Drain-to-Source Voltage	Q1		$V_{DSS}$	30	V		
Drain-to-Source Voltage	Q2						
Gate-to-Source Voltage	Q1		$V_{GS}$	$\pm 20$	V		
Gate-to-Source Voltage	Q2						
Continuous Drain Current $R_{\theta JA}$ (Note 1)		Steady State	$I_D$	$T_A = 25^\circ\text{C}$	13.5	A	
				$T_A = 85^\circ\text{C}$	9.7		
				$T_A = 25^\circ\text{C}$	17.5		
				$T_A = 85^\circ\text{C}$	12.6		
Power Dissipation $R_{\theta JA}$ (Note 1)			$P_D$	$T_A = 25^\circ\text{C}$	1.90	W	
				$T_A = 85^\circ\text{C}$	1.99		
Continuous Drain Current $R_{\theta JA} \leq 10$ s (Note 1)		Steady State	$I_D$	$T_A = 25^\circ\text{C}$	18.2	A	
				$T_A = 85^\circ\text{C}$	13.1		
				$T_A = 25^\circ\text{C}$	23		
				$T_A = 85^\circ\text{C}$	16.6		
Power Dissipation $R_{\theta JA} \leq 10$ s (Note 1)			$P_D$	$T_A = 25^\circ\text{C}$	3.45	W	
				$T_A = 85^\circ\text{C}$	3.45		
Continuous Drain Current $R_{\theta JA}$ (Note 2)		Steady State	$I_D$	$T_A = 25^\circ\text{C}$	10.3	A	
				$T_A = 85^\circ\text{C}$	7.4		
				$T_A = 25^\circ\text{C}$	13.3		
				$T_A = 85^\circ\text{C}$	9.6		
Power Dissipation $R_{\theta JA}$ (Note 2)			$P_D$	$T_A = 25^\circ\text{C}$	1.10	W	
				$T_A = 85^\circ\text{C}$	1.16		
Pulsed Drain Current			$I_{DM}$	$T_A = 25^\circ\text{C}$ $t_p = 10 \mu\text{s}$	60	A	
					80		
Operating Junction and Storage Temperature			Q1	$T_J, T_{STG}$	-55 to +150	$^\circ\text{C}$	
			Q2				
Source Current (Body Diode)			Q1	$I_S$	3.4	A	
			Q2		4.9		
Drain to Source $dV/dt$				$dV/dt$	6.0	V/ns	
Single Pulse Drain-to-Source Avalanche Energy ( $T_J = 25^\circ\text{C}$ , $V_{DD} = 50$ V, $V_{GS} = 10$ V, $I_L = XX A_{pk}$ , $L = 0.1$ mH, $R_G = 25 \Omega$ )			24 A	Q1	EAS	28.8	mJ
			27 A	Q2	EAS	36.5	
Lead Temperature for Soldering Purposes (1/8" from case for 10 s)				$T_L$	260	$^\circ\text{C}$	

Stresses exceeding those listed in the Maximum Ratings table may damage the device. If any of these limits are exceeded, device functionality should not be assumed, damage may occur and reliability may be affected.

- Surface-mounted on FR4 board using 1 sq-in pad, 2 oz Cu.
- Surface-mounted on FR4 board using the minimum recommended pad size of 100 mm<sup>2</sup>.

# NTMFD4902NF

## THERMAL RESISTANCE MAXIMUM RATINGS

Parameter	FET	Symbol	Value	Unit
Junction-to-Ambient – Steady State (Note 3)	Q1	R <sub>θJA</sub>	65.9	°C/W
	Q2		62.8	
Junction-to-Ambient – Steady State (Note 4)	Q1	R <sub>θJA</sub>	113.2	
	Q2		108	
Junction-to-Ambient – (t ≤ 10 s) (Note 3)	Q1	R <sub>θJA</sub>	36.2	
	Q2		36.2	

3. Surface-mounted on FR4 board using 1 sq-in pad, 2 oz Cu.

4. Surface-mounted on FR4 board using the minimum recommended pad size of 100 mm<sup>2</sup>.

## ELECTRICAL CHARACTERISTICS (T<sub>J</sub> = 25°C unless otherwise specified)

Parameter	FET	Symbol	Test Condition	Min	Typ	Max	Unit
<b>OFF CHARACTERISTICS</b>							
Drain-to-Source Break-down Voltage	Q1	V <sub>(BR)DSS</sub>	V <sub>GS</sub> = 0 V, I <sub>D</sub> = 250 μA	30			V
	Q2		V <sub>GS</sub> = 0 V, I <sub>D</sub> = 1.0 mA	30			
Drain-to-Source Break-down Voltage Temperature Coefficient	Q1	V <sub>(BR)DSS</sub> / T <sub>J</sub>			18		mV / °C
	Q2				15		
Zero Gate Voltage Drain Current	Q1	I <sub>DSS</sub>	V <sub>GS</sub> = 0 V, V <sub>DS</sub> = 24 V	T <sub>J</sub> = 25°C		1	μA
				T <sub>J</sub> = 125°C		10	
	Q2		V <sub>GS</sub> = 0 V, V <sub>DS</sub> = 24 V	T <sub>J</sub> = 25°C		500	
Gate-to-Source Leakage Current	Q1	I <sub>GSS</sub>	V <sub>GS</sub> = 0 V, V <sub>DS</sub> = ±20 V			±100	nA
	Q2					±100	

## ON CHARACTERISTICS (Note 5)

Gate Threshold Voltage	Q1	V <sub>GS(TH)</sub>	V <sub>GS</sub> = V <sub>DS</sub> , I <sub>D</sub> = 250 μA		1.2		2.2	V
	Q2				1.2		2.2	
Negative Threshold Temperature Coefficient	Q1	V <sub>GS(TH)</sub> / T <sub>J</sub>				4.5		mV / °C
	Q2					4.0		
Drain-to-Source On Resistance	Q1	R <sub>DS(on)</sub>	V <sub>GS</sub> = 10 V	I <sub>D</sub> = 10 A		5.2	6.5	mΩ
			V <sub>GS</sub> = 4.5 V	I <sub>D</sub> = 10 A		8.0	10	
	Q2		V <sub>GS</sub> = 10 V	I <sub>D</sub> = 15 A		3.3	4.1	
			V <sub>GS</sub> = 4.5 V	I <sub>D</sub> = 15 A		5.0	6.2	
Forward Transconductance	Q1	g <sub>FS</sub>	V <sub>DS</sub> = 1.5 V, I <sub>D</sub> = 10 A			28		S
	Q2					35		

## CHARGES, CAPACITANCES & GATE RESISTANCE

Input Capacitance	Q1	C <sub>ISS</sub>	V <sub>GS</sub> = 0 V, f = 1 MHz, V <sub>DS</sub> = 15 V		1150		pF
	Q2				1590		
Output Capacitance	Q1	C <sub>OSS</sub>			360		
	Q2				813		
Reverse Capacitance	Q1	C <sub>RSS</sub>			105		
	Q2				83		

Product parametric performance is indicated in the Electrical Characteristics for the listed test conditions, unless otherwise noted. Product performance may not be indicated by the Electrical Characteristics if operated under different conditions.

5. Pulse Test: pulse width ≤ 300 μs, duty cycle ≤ 2%.

6. Switching characteristics are independent of operating junction temperatures.

# NTMFD4902NF

## ELECTRICAL CHARACTERISTICS (T<sub>J</sub> = 25°C unless otherwise specified)

Parameter	FET	Symbol	Test Condition	Min	Typ	Max	Unit
-----------	-----	--------	----------------	-----	-----	-----	------

### CHARGES, CAPACITANCES & GATE RESISTANCE

Total Gate Charge	Q1	Q <sub>G(TOT)</sub>	V <sub>GS</sub> = 4.5 V, V <sub>DS</sub> = 15 V; I <sub>D</sub> = 10 A		9.7		nC		
	Q2				11.5				
Threshold Gate Charge	Q1	Q <sub>G(TH)</sub>			1.1				
	Q2				1.4				
Gate-to-Source Charge	Q1	Q <sub>GS</sub>			3.3				
	Q2				4.2				
Gate-to-Drain Charge	Q1	Q <sub>GD</sub>			3.7				
	Q2				3.4				
Total Gate Charge	Q1	Q <sub>G(TOT)</sub>		V <sub>GS</sub> = 10 V, V <sub>DS</sub> = 15 V; I <sub>D</sub> = 10 A		19.1			nC
	Q2					24.9			

### SWITCHING CHARACTERISTICS (Note 6)

Turn-On Delay Time	Q1	t <sub>d(ON)</sub>	V <sub>GS</sub> = 4.5 V, V <sub>DS</sub> = 15 V, I <sub>D</sub> = 10 A, R <sub>G</sub> = 3.0 Ω		9.0		ns
	Q2				10.5		
Rise Time	Q1	t <sub>r</sub>			15		
	Q2				15.2		
Turn-Off Delay Time	Q1	t <sub>d(OFF)</sub>			14		
	Q2				17.7		
Fall Time	Q1	t <sub>f</sub>			4.0		
	Q2				4.7		

### SWITCHING CHARACTERISTICS (Note 6)

Turn-On Delay Time	Q1	t <sub>d(ON)</sub>	V <sub>GS</sub> = 10 V, V <sub>DS</sub> = 15 V, I <sub>D</sub> = 10 A, R <sub>G</sub> = 3.0 Ω		6.0		ns
	Q2				7.0		
Rise Time	Q1	t <sub>r</sub>			14		
	Q2				14		
Turn-Off Delay Time	Q1	t <sub>d(OFF)</sub>			17		
	Q2				22		
Fall Time	Q1	t <sub>f</sub>			3.0		
	Q2				3.3		

### DRAIN-SOURCE DIODE CHARACTERISTICS

Forward Voltage	Q1	V <sub>SD</sub>	V <sub>GS</sub> = 0 V, I <sub>S</sub> = 3 A	T <sub>J</sub> = 25°C		0.75	1.0	V
				T <sub>J</sub> = 125°C		0.62		
	Q2		V <sub>GS</sub> = 0 V, I <sub>S</sub> = 2 A	T <sub>J</sub> = 25°C		0.37	0.70	
				T <sub>J</sub> = 125°C		0.31		

Product parametric performance is indicated in the Electrical Characteristics for the listed test conditions, unless otherwise noted. Product performance may not be indicated by the Electrical Characteristics if operated under different conditions.

5. Pulse Test: pulse width ≤ 300 μs, duty cycle ≤ 2%.

6. Switching characteristics are independent of operating junction temperatures.

# NTMFD4902NF

## ELECTRICAL CHARACTERISTICS (T<sub>J</sub> = 25°C unless otherwise specified)

Parameter	FET	Symbol	Test Condition	Min	Typ	Max	Unit
<b>DRAIN-SOURCE DIODE CHARACTERISTICS</b>							
Reverse Recovery Time	Q1	t <sub>RR</sub>	V <sub>GS</sub> = 0 V, d <sub>IS</sub> /d <sub>t</sub> = 100 A/μs, I <sub>S</sub> = 3 A		23		ns
	Q2				24.5		
Charge Time	Q1	t <sub>a</sub>			12		
	Q2				13		
Discharge Time	Q1	t <sub>b</sub>			11		
	Q2				11.5		
Reverse Recovery Charge	Q1	Q <sub>RR</sub>			12		nC
	Q2				24		

## PACKAGE PARASITIC VALUES

Source Inductance	Q1	L <sub>S</sub>	T <sub>A</sub> = 25°C		0.38		nH
	Q2				0.65		
Drain Inductance	Q1	L <sub>D</sub>			0.054		nH
	Q2				0.007		
Gate Inductance	Q1	L <sub>G</sub>			1.5		nH
	Q2				1.5		
Gate Resistance	Q1	R <sub>G</sub>			0.8		Ω
	Q2				0.8		

Product parametric performance is indicated in the Electrical Characteristics for the listed test conditions, unless otherwise noted. Product performance may not be indicated by the Electrical Characteristics if operated under different conditions.

5. Pulse Test: pulse width ≤ 300 μs, duty cycle ≤ 2%.

6. Switching characteristics are independent of operating junction temperatures.

## ORDERING INFORMATION

Device	Package	Shipping†
NTMFD4902NFT1G	DFN8 (Pb-Free)	1500 / Tape & Reel
NTMFD4902NFT3G	DFN8 (Pb-Free)	5000 / Tape & Reel

†For information on tape and reel specifications, including part orientation and tape sizes, please refer to our Tape and Reel Packaging Specifications Brochure, BRD8011/D.

TYPICAL CHARACTERISTICS – Q1

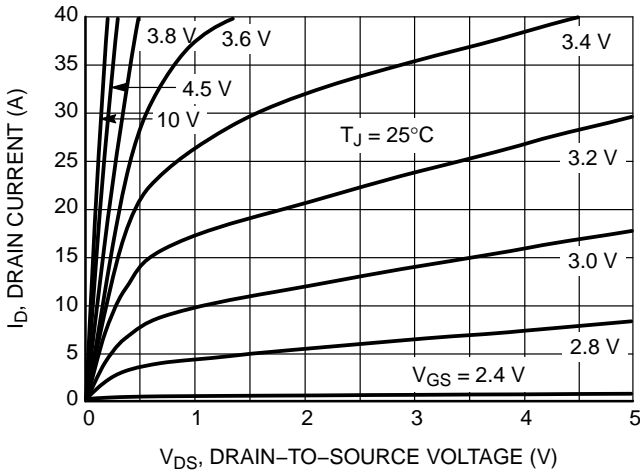

Figure 1. On-Region Characteristics

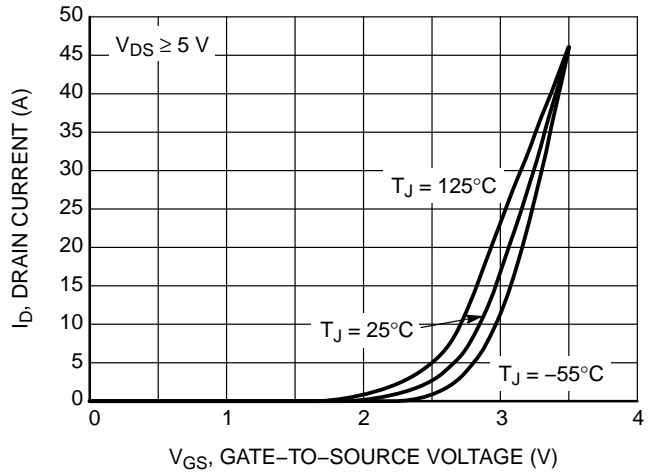

Figure 2. Transfer Characteristics

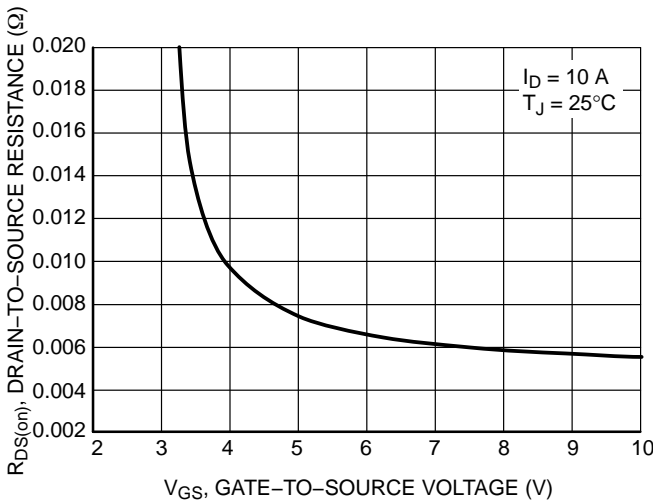

Figure 3. On-Resistance vs. Gate-to-Source Resistance

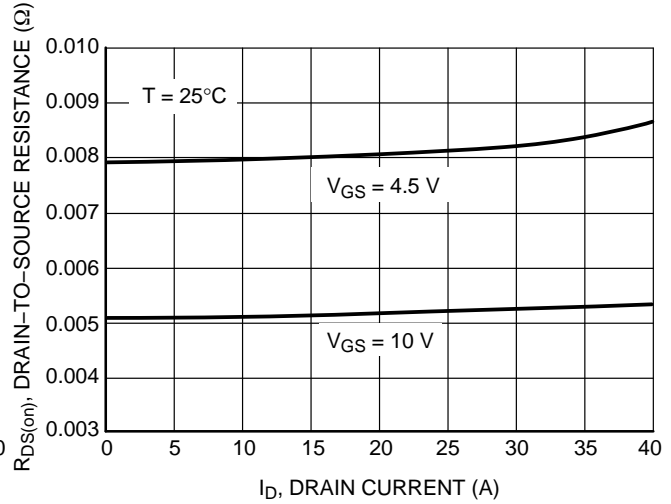

Figure 4. On-Resistance vs. Drain Current and Gate Voltage

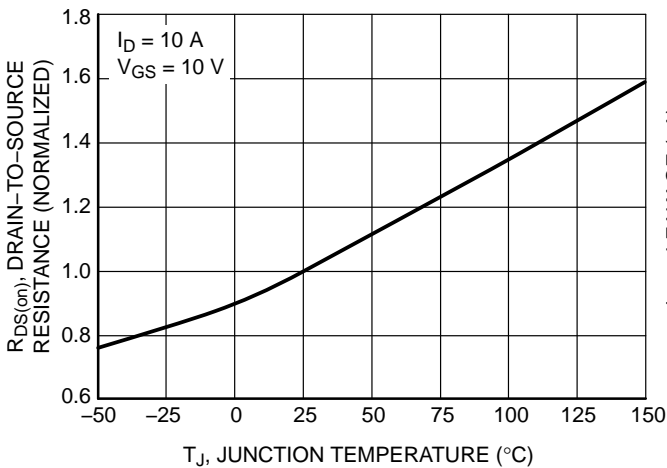

Figure 5. On-Resistance Variation with Temperature

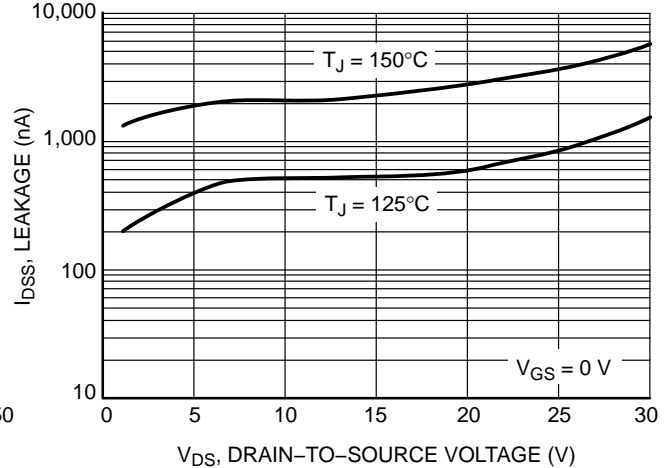
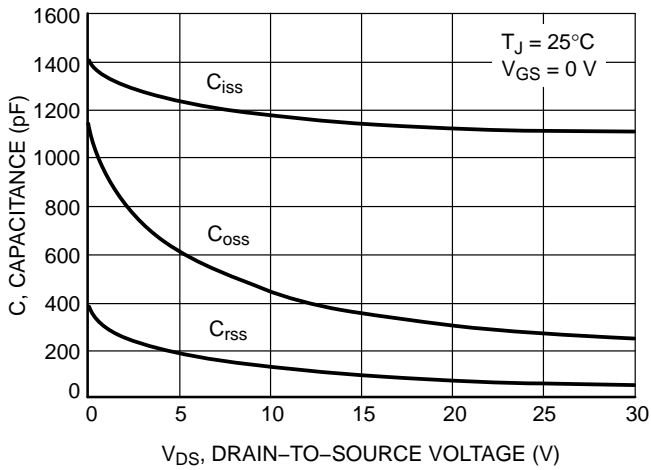

Figure 6. Drain-to-Source Leakage Current vs. Voltage

# NTMFD4902NF

## TYPICAL CHARACTERISTICS – Q1



**Figure 7. Capacitance Variation**

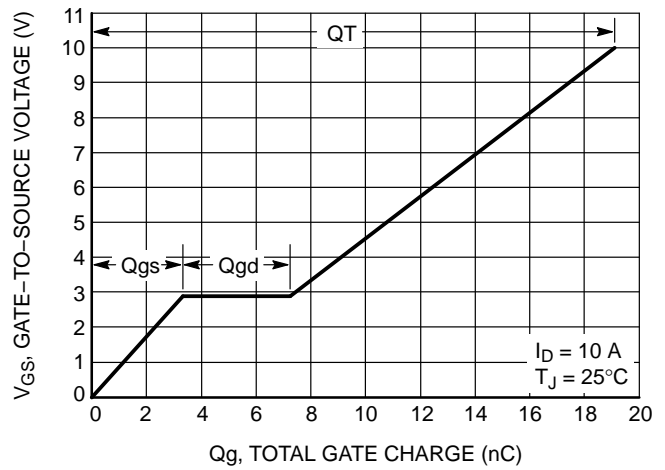

**Figure 8. Gate-to-Source and Drain-to-Source Voltage vs. Total Charge**

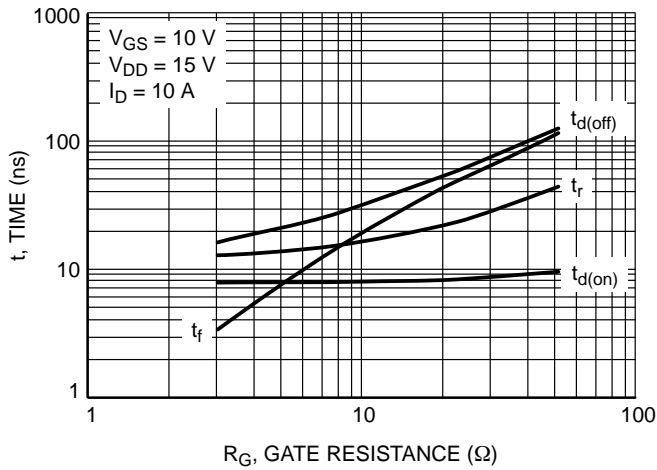

**Figure 9. Resistive Switching Time Variation vs. Gate Resistance**

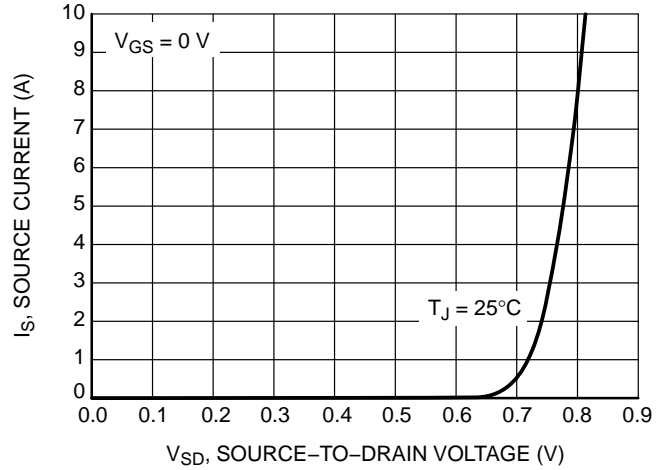

**Figure 10. Diode Forward Voltage vs. Current**

TYPICAL CHARACTERISTICS – Q2

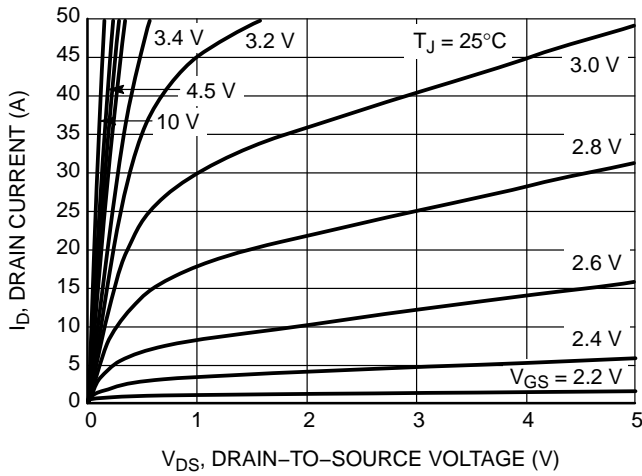

Figure 11. On-Region Characteristics

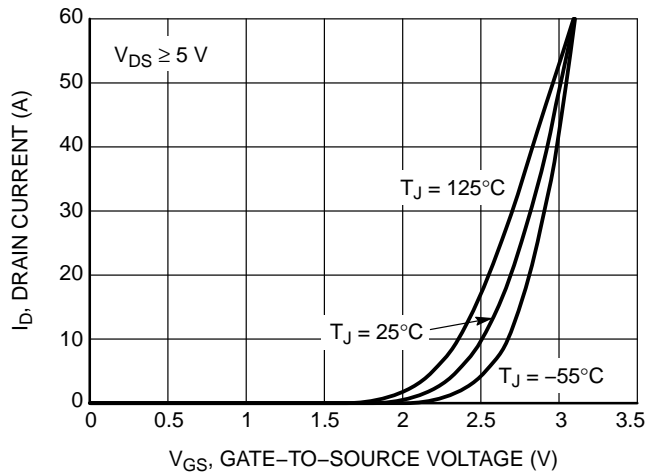

Figure 12. Transfer Characteristics

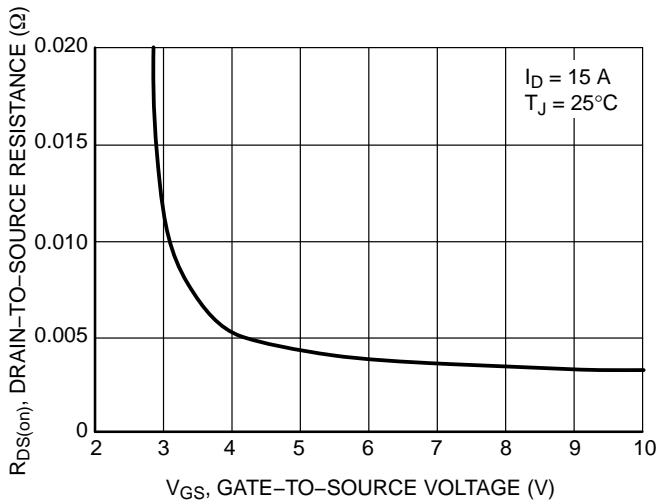

Figure 13. On-Resistance vs. Gate-to-Source Resistance

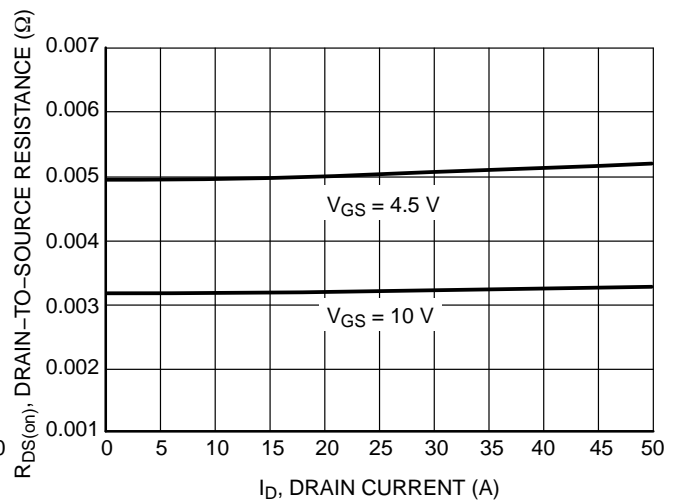

Figure 14. On-Resistance vs. Drain Current and Gate Voltage

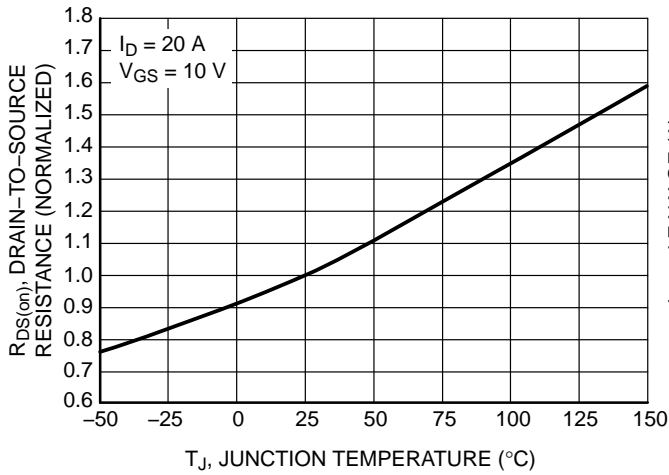

Figure 15. On-Resistance Variation with Temperature

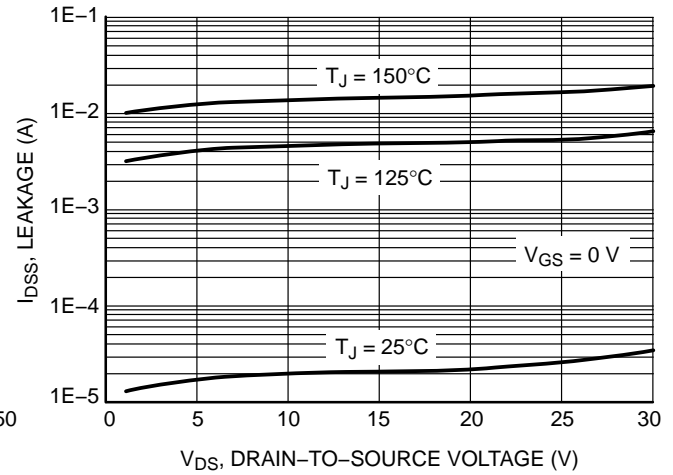
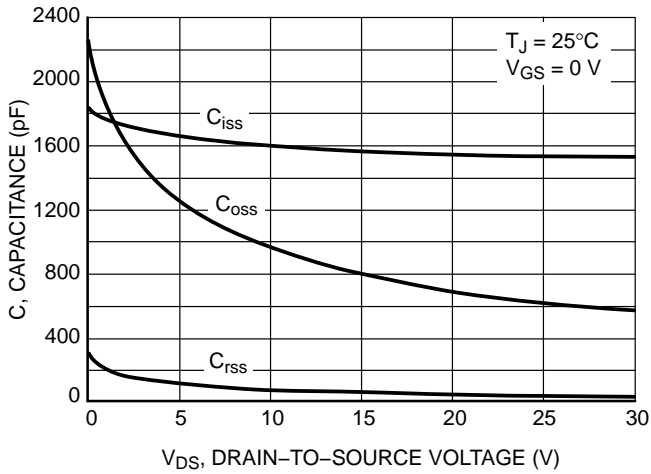

Figure 16. Drain-to-Source Leakage Current vs. Voltage



# NTMFD4902NF

## TYPICAL CHARACTERISTICS – Q2



**Figure 17. Capacitance Variation**

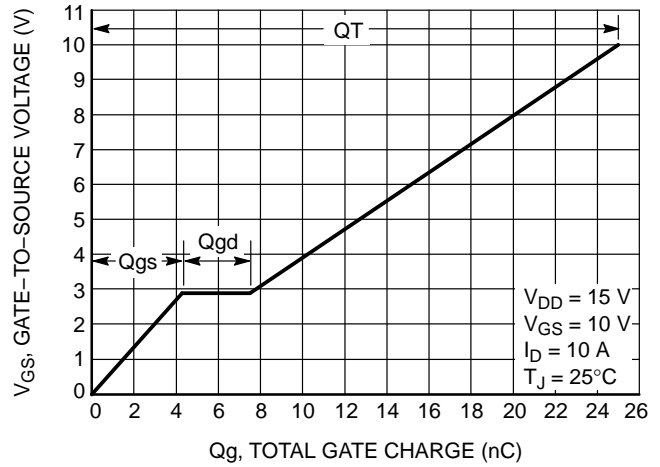

**Figure 18. Gate-to-Source and Drain-to-Source Voltage vs. Total Charge**

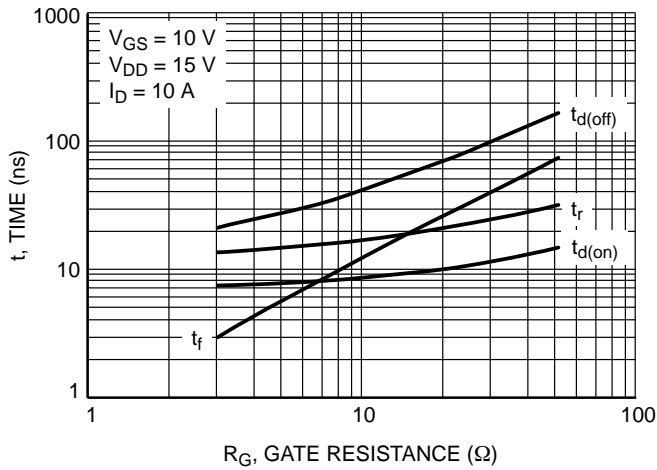

**Figure 19. Resistive Switching Time Variation vs. Gate Resistance**

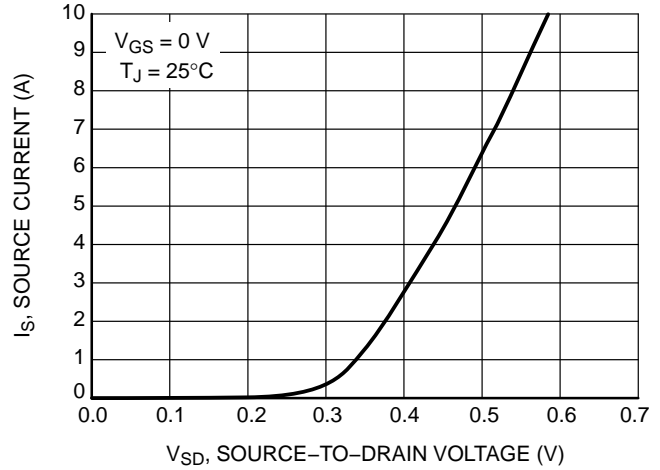
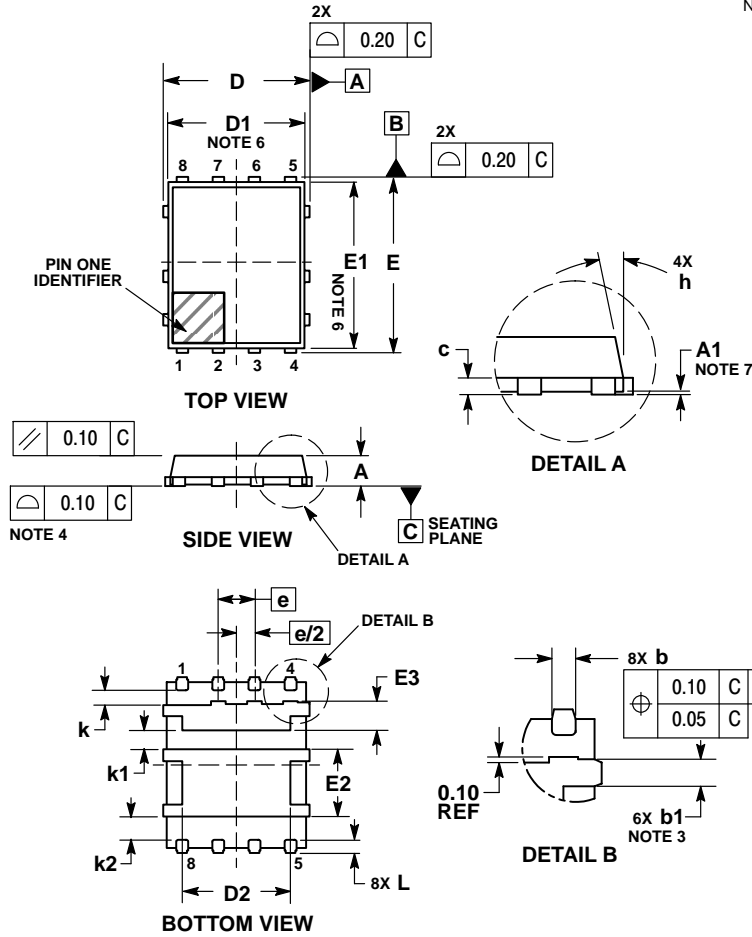

**Figure 20. Diode Forward Voltage vs. Current**

# NTMFD4902NF

## PACKAGE DIMENSIONS

### DFN8 5x6, 1.27P Dual Flag (SO8FL–Dual–Asymmetrical) CASE 506BX ISSUE D



#### NOTES:

1. DIMENSIONING AND TOLERANCING PER ASME Y14.5M, 1994.
2. CONTROLLING DIMENSION: MILLIMETERS.
3. DIMENSION b APPLIES TO PLATED TERMINAL AND IS MEASURED BETWEEN 0.15 AND 0.25 MM FROM THE TERMINAL TIP.
4. COPLANARITY APPLIES TO THE EXPOSED PADS AS WELL AS THE TERMINALS.
5. DIMENSIONS b AND L ARE MEASURED AT THE PACKAGE SURFACE.
6. DIMENSIONS D1 AND E1 DO NOT INCLUDE MOLD FLASH, PROTRUSIONS, OR GATE BURRS.
7. SEATING PLANE IS DEFINED BY THE TERMINALS. A1 IS DEFINED AS THE DISTANCE FROM THE SEATING PLANE TO THE LOWEST POINT ON THE PACKAGE BODY.

DIM	MILLIMETERS	
	MIN	MAX
A	0.90	1.10
A1	0.00	0.05
b	0.41	0.61
b1	0.41	0.61
c	0.23	0.33
D	5.00	5.30
D1	4.50	5.10
D2	3.50	4.22
E	6.00	6.30
E1	5.50	6.10
E2	2.27	2.67
E3	0.82	1.22
e	1.27 BSC	
h	—	12 °
k	0.39	0.59
k1	0.56	0.76
k2	0.73	0.93
L	0.35	0.55

#### RECOMMENDED SOLDERING FOOTPRINT\*

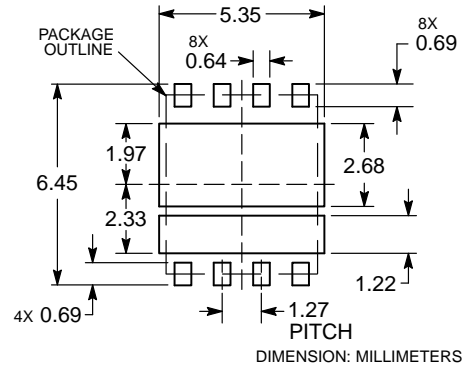

\*For additional information on our Pb–Free strategy and soldering details, please download the ON Semiconductor Soldering and Mounting Techniques Reference Manual, SOLDERRM/D.

ON Semiconductor and the are registered trademarks of Semiconductor Components Industries, LLC (SCILLC) or its subsidiaries in the United States and/or other countries. SCILLC owns the rights to a number of patents, trademarks, copyrights, trade secrets, and other intellectual property. A listing of SCILLC's product/patent coverage may be accessed at [www.onsemi.com/site/pdf/Patent-Marking.pdf](http://www.onsemi.com/site/pdf/Patent-Marking.pdf). SCILLC reserves the right to make changes without further notice to any products herein. SCILLC makes no warranty, representation or guarantee regarding the suitability of its products for any particular purpose, nor does SCILLC assume any liability arising out of the application or use of any product or circuit, and specifically disclaims any and all liability, including without limitation special, consequential or incidental damages. "Typical" parameters which may be provided in SCILLC data sheets and/or specifications can and do vary in different applications and actual performance may vary over time. All operating parameters, including "Typicals" must be validated for each customer application by customer's technical experts. SCILLC does not convey any license under its patent rights nor the rights of others. SCILLC products are not designed, intended, or authorized for use as components in systems intended for surgical implant into the body, or other applications intended to support or sustain life, or for any other application in which the failure of the SCILLC product could create a situation where personal injury or death may occur. Should Buyer purchase or use SCILLC products for any such unintended or unauthorized application, Buyer shall indemnify and hold SCILLC and its officers, employees, subsidiaries, affiliates, and distributors harmless against all claims, costs, damages, and expenses, and reasonable attorney fees arising out of, directly or indirectly, any claim of personal injury or death associated with such unintended or unauthorized use, even if such claim alleges that SCILLC was negligent regarding the design or manufacture of the part. SCILLC is an Equal Opportunity/Affirmative Action Employer. This literature is subject to all applicable copyright laws and is not for resale in any manner.

#### PUBLICATION ORDERING INFORMATION

**LITERATURE FULFILLMENT:**  
Literature Distribution Center for ON Semiconductor  
P.O. Box 5163, Denver, Colorado 80217 USA  
Phone: 303-675-2175 or 800-344-3860 Toll Free USA/Canada  
Fax: 303-675-2176 or 800-344-3867 Toll Free USA/Canada  
Email: [orderlit@onsemi.com](mailto:orderlit@onsemi.com)

**N. American Technical Support:** 800-282-9855 Toll Free  
USA/Canada  
**Europe, Middle East and Africa Technical Support:**  
Phone: 421 33 790 2910  
**Japan Customer Focus Center**  
Phone: 81-3-5817-1050

**ON Semiconductor Website:** [www.onsemi.com](http://www.onsemi.com)  
**Order Literature:** <http://www.onsemi.com/orderlit>  
For additional information, please contact your local Sales Representative

# Mouser Electronics

Authorized Distributor

Click to View Pricing, Inventory, Delivery & Lifecycle Information:

[ON Semiconductor:](#)

[NTMFD4902NFT1G](#) [NTMFD4902NFT3G](#)