

INTRODUCTIONS

1. Designed as a general purpose filter providing effective EMI suppression.
2. All part numbers are UL recognized, CSA certified and VDE approved.

COMPONENTS

PARTNO.	Cx(μF)	L(mH)	Cy(pF)	R(Ω)
* 02DBAG5	0.1	1.1	3300	-
* 02DBAW5				
* 03DBAG5		2.8		
* 03DBAW5				
* 05DBAG5		2.9		
* 05DBAW5	0.47	3.7	330K	
06BDW3S				
* 10DBAG5	0.1	1.5	3300	-
* 10DBAW5				
* 10DBAS5				
10DBG3S	0.47	1.45	330K	
20DBAG5	0.33	0.7	3300	-
20DBAS5				
12DBG5B	0.1	0.7	4700	1.0M
16BDCG5B		0.65		
16BDCW5B				
20BDCG5B		0.60		
20BDCS5B				
30BDCS5B	0.47	0.67	10000	

- UL & CSA approved only.
- * OPTION 300V

MINIMUM INSERTION LOSS IN dB

COMMON MODE (L-G) IN 50 OHM SYSTEM						
CURRENT RATING	FREQUENCY-MHz					
	.15	.50	1.0	5.0	10	30
2,3,5A	15	30	38	45	45	40
6A	20	25	35	40	45	35
10A	20	30	35	50	50	45
* 10A	15	22	30	40	40	45
20A	13	20	25	40	45	45
12A (BG5B)	10	20	22	35	40	40
16A (CG5B) (CW5B)	10	18	20	35	50	30
20A (CG5B) (CS5B)	10	20	22	30	35	35
30A (CS5B)	10	28	30	45	50	35
DIFFERENTIAL MODE (L-L) IN 50 OHM SYSTEM						
2,3,5A	6	15	20	40	45	45
6A	10	18	20	30	35	40
10A	6	15	20	44	45	45
* 10A	12	18	20	35	35	40
20A	15	24	28	45	45	45
12A (BG5B)	5	12	15	35	45	35
16A (CG5B) (CW5B)	5	10	15	45	45	40
20A (CG5B) (CS5B)	4	10	15	45	45	40
30A (CS5B)	12	20	25	45	50	45

* 10DBG3S, DW3S

SPECIFICATIONS

1. Maximum leakage current each
 line-to-ground @ 115VAC 60Hz: 0.25mA
 1.0mA (10000pF)
 @ 250VAC 50Hz: 0.45mA
 2.0mA (10000pF)
2. Hipot rating (one minute)
 line-to-ground: 2250VDC
 line-to-line: 1450VDC
3. Operating frequency: 50/60Hz
4. Rated voltage: 115/250VAC

SERIES DIMENSIONS

CURRENT RATING	STYLE	DIMENSIONS IN INCHES/mm				
		A	B	C	D	E
2A	AG5	2.15	45.0	0.65	2.13	2.54
		54.6				
	AW5	0.96		24.4		
3A	AG5	2.54	1.77	19.5	54.1	2.50
	64.5					
	AW5	1.33	33.8			
5A	AG5	2.54	45.0	19.5	54.1	63.5
	64.5					
	AW5	1.33				
6A	DW3S	2.55	2.08	1.29	1.575	0.61
		64.77	52.83	32.77	40.01	15.49
10A	AG5	2.54	45.0	1.18	54.1	2.50
		64.5				
	AW5	1.33		33.8		
	AS5	3.10	2.02	1.18	2.38	2.77
		78.7	51.3	30.0	60.5	70.3
DG3S	3.14	2.10	1.28	1.575	0.61	
	79.80	53.30	32.50	40.00	15.50	
20A	AG5	3.25	2.02	1.16	2.38	2.75
		82.5	51.3	29.5	60.5	69.9
	AS5	3.37	2.02	1.15	2.38	2.77
		85.6	51.3	29.2	60.5	70.3

CURRENT RATING	STYLE	DIMENSIONS IN INCHES/mm					
		A	B	C	D	E	F
12A	BG5B	2.13	2.54	1.34	1.77	30.0	-
		54.00	64.5	34.0	45.0		
16A	CG5B	2.40	2.81	1.79	2.02	30.0	-
	61.00	71.5	45.5	51.3	3.94		
20A	CG5B	2.95	3.34	2.04	2.52	30.0	-
	75.00	84.8	51.8	64.0			
30A	CS5B	4.06	4.49	2.22	3.74	1.83	-
		103.0	114.0	56.5	95.0	46.4	

ELECTRICAL SCHEMATIC

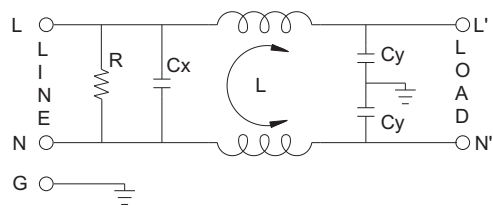
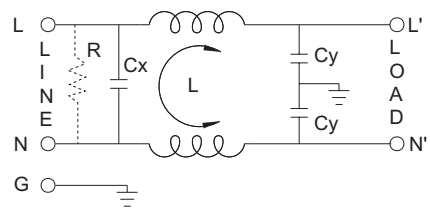

XXDBXX5B

INSERTION LOSS (TYPICAL)

02DBAG5----- COMMON MODE ----- DIFF. MODE
03DBAG5----- COMMON MODE ----- DIFF. MODE

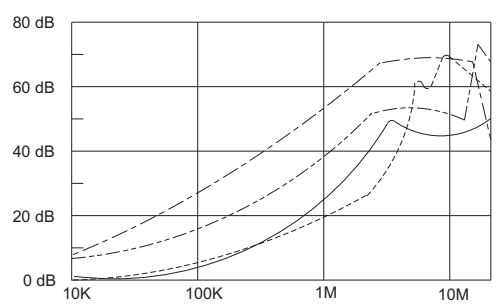

05DBAG5----- COMMON MODE ----- DIFF. MODE
10DBAG5----- COMMON MODE ----- DIFF. MODE

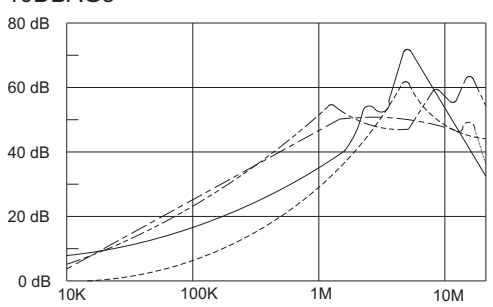

20DBAG5----- COMMON MODE ----- DIFF. MODE

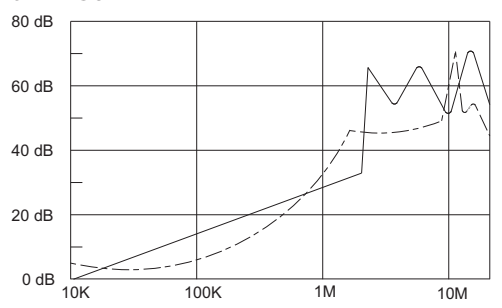

20DBC5B ----- COMMON MODE ----- DIFF. MODE
20BCS5B ----- COMMON MODE ----- DIFF. MODE
30BCS5B ----- COMMON MODE ----- DIFF. MODE

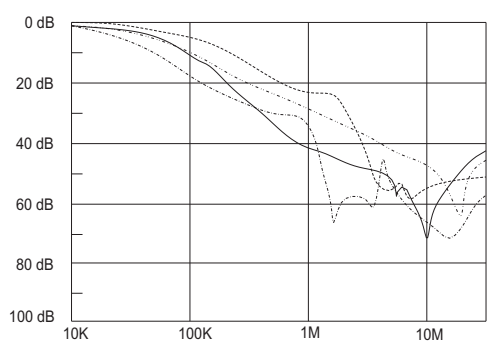

12DBBG5B ----- COMMON MODE ----- DIFF. MODE

16DBC5B ----- COMMON MODE ----- DIFF. MODE
16DBCW5B ----- COMMON MODE ----- DIFF. MODE

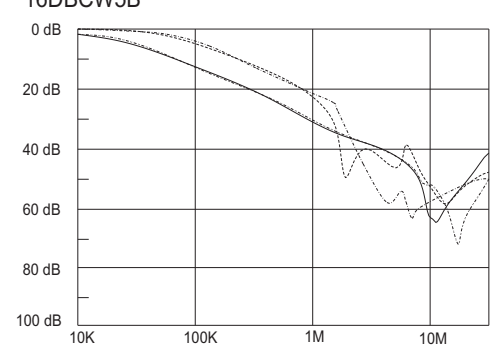

MECHANICAL CONSTRUCTION

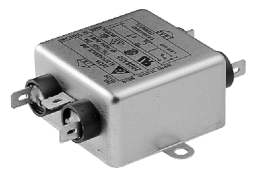

AG5

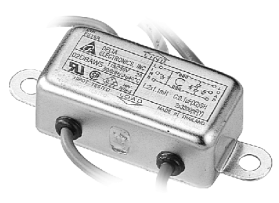
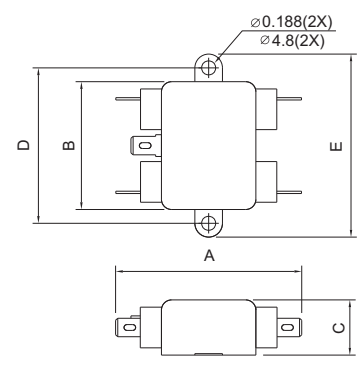

AW5

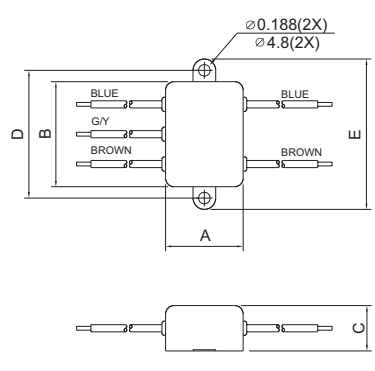

CG5

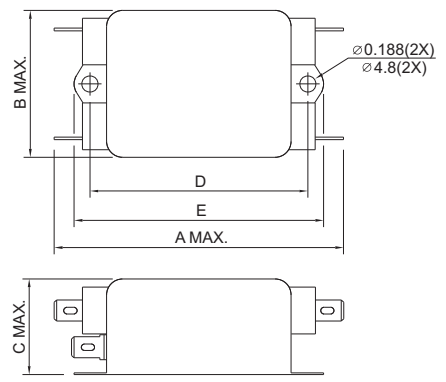

DW3S

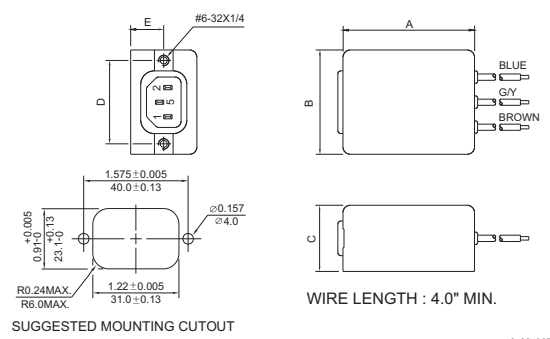

UNIT: INCH
mm

MECHANICAL CONSTRUCTION



DG3

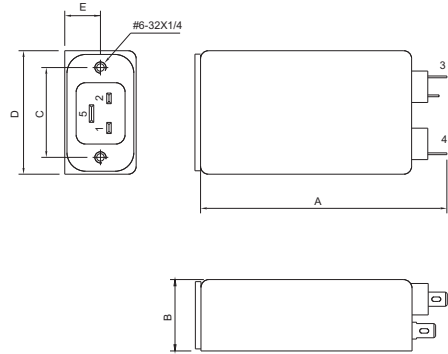

DG3S

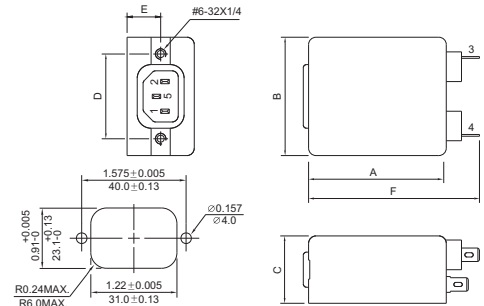

SUGGESTED MOUNTING CUTOUT

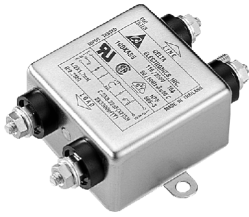

AS5

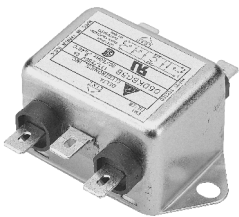
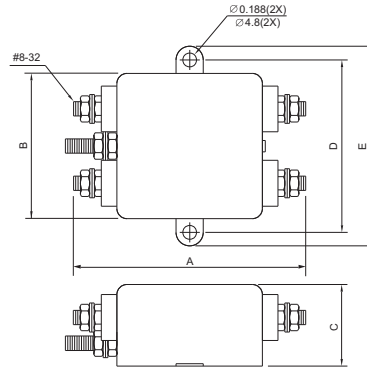

BG5B
(option wire style)

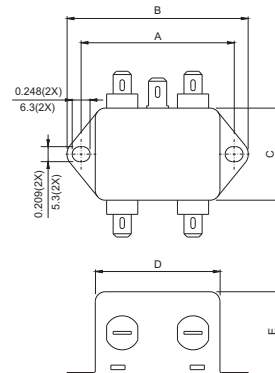

MECHANICAL CONSTRUCTION



CG5B



CW5B



CS5B

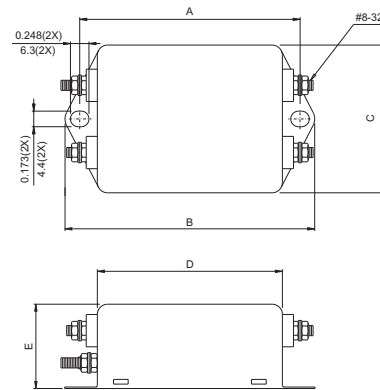
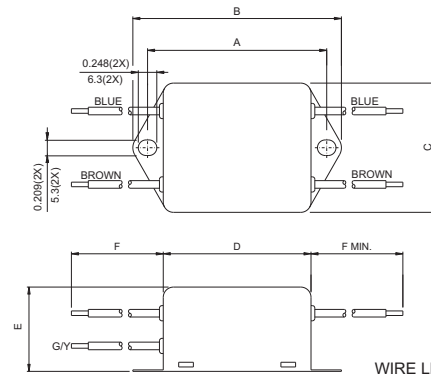
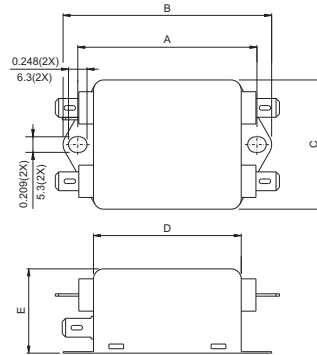

UNIT: $\frac{\text{INCH}}{\text{mm}}$

Mouser Electronics

Authorized Distributor

Click to View Pricing, Inventory, Delivery & Lifecycle Information:

[Delta Electronics:](#)

[30DBCS5B](#) [20DBAS5](#) [05DBAW5](#) [12DBBG5B](#) [16DBCG5B](#) [16DBCW5B](#) [10DBAS5](#) [01DBAW5](#) [06DBDW3S](#)
[03DBDW3S](#) [05DBAG5](#) [10DBAG5](#) [10DBDW3S](#) [20DBCS5B](#) [01DBAG5](#) [20DBCG5B](#) [02DBAW5](#) [02DBAG5](#)
[03DBAG5](#) [03DBAW5](#) [20DBAG5](#) [10DBAW5](#)