

Description

The AL8808 is a step-down DC/DC converter designed to drive LEDs with a constant current. The device can drive up to 8 LEDs, depending on the forward voltage of the LEDs, in series from a voltage source of 6V to 30V. Series connection of the LEDs provides identical LED currents resulting in uniform brightness and eliminating the need for ballast resistors. The AL8808 switches at frequency up to 1MHz with controlled rise and fall times to reduce EMI. This allows the use of small size external components, hence minimizing the PCB area needed.

Maximum output current of AL8808 is set via an external resistor connected between the V_{IN} and SET input pins. Dimming is achieved by applying either an analog DC voltage or a PWM signal at the CTRL input pin. An input voltage of 0.4V or lower at CTRL switches off the output MOSFET simplifying PWM dimming.

Applications

- MR16 Lamps
- General Illumination Lamps

Pin Assignments

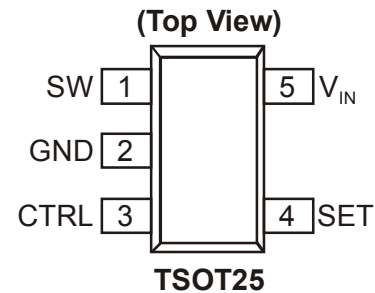

Features

- LED Driving Current Up to 1A
- Better Than 5% Accuracy
- High Efficiency Up to 96%
- Fast Controlled Falling Edges 7ns
- Operating Input Voltage from 6V to 30V
- High Switching Frequency Up to 1MHz
- PWM/DC Input for Dimming Control
- Built-In Output Open-Circuit Protection
- Built-In Over-Temperature Protection
- TSOT25: Available in "Green" Molding Compound (No Br, Sb)
 - **Totally Lead-Free & Fully RoHS Compliant (Notes 1 & 2)**
 - **Halogen and Antimony Free. "Green" Device (Note 3)**

Notes:

1. No purposely added lead. Fully EU Directive 2002/95/EC (RoHS) & 2011/65/EU (RoHS 2) compliant.
2. See <http://www.diodes.com> for more information about Diodes Incorporated's definitions of Halogen and Antimony free, "Green" and Lead-Free.
3. Halogen and Antimony free "Green" products are defined as those which contain <900ppm bromine, <900ppm chlorine (<1500ppm total Br + Cl) and <1000ppm antimony compounds.

Typical Applications Circuit

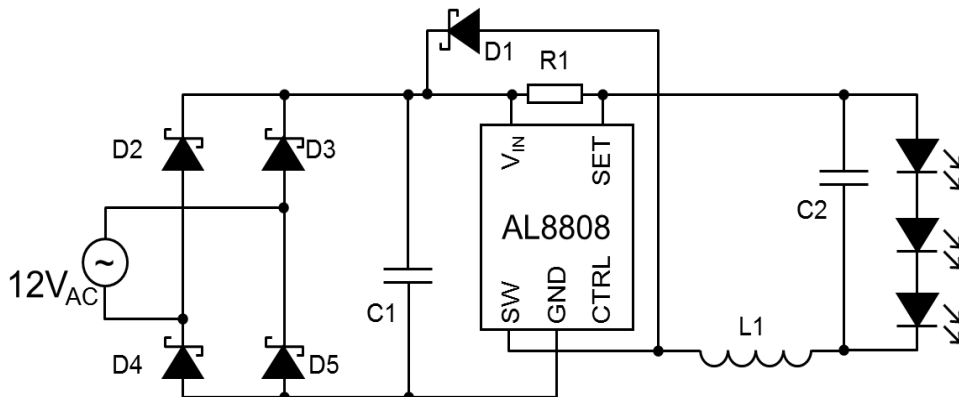

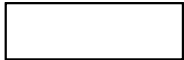

Pin Descriptions

| Pin Number | Pin Name | Function |
|------------|----------|---|
| 1 | SW | Switch Pin. Connect inductor/freewheeling diode here, minimizing track length at this pin to reduce EMI. |
| 2 | GND | GND Pin |
| 3 | CTRL | Dimming and On/Off Control Input. <ul style="list-style-type: none"> Leave floating for normal operation. ($V_{CTRL} = 5V$, Gives nominal average output current $I_{OUTnom} = 0.1/R_S$) Drive to voltage below 0.4V to turn off output current Drive with an analog voltage ($0.5V < V_{CTRL} < 2.5V$) to adjust output current from 20% to 100% of I_{OUTnom} Drive with an analog voltage $> 2.6V$ output current will be 100% of I_{OUTnom} A PWM signal (low level $\leq 0.4V$ and high level > 2.6; transition times less than $1\mu s$) allows the output current to be adjusted below the level set by the resistor connected to SET input pin. |
| 4 | SET | Set Nominal Output Current Pin. Configure the output current of the device. |
| 5 | V_{IN} | Input Supply Pin. Must be locally decoupled to GND with $\geq 2.2\mu F$ X7R ceramic capacitor – see applications section for more information. |

Functional Block Diagram

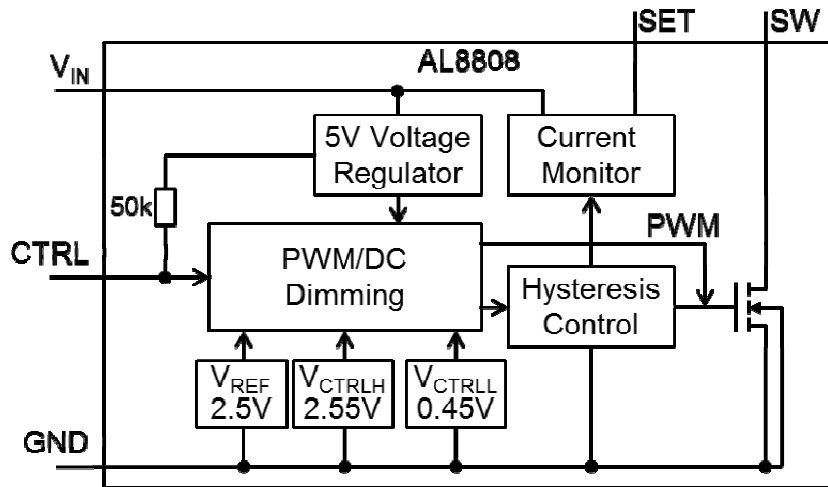

Figure 1. AL8808 Block Diagram

Absolute Maximum Ratings (@ $T_A = +25^\circ C$, unless otherwise specified.)

| Symbol | Parameter | Ratings | Unit |
|------------|---|-------------|------------|
| ESD HBM | Human Body Model ESD Protection | 2.5 | kV |
| ESD MM | Machine Model ESD Protection | 200 | V |
| V_{IN} | Continuous V_{IN} pin voltage relative to GND | -0.3 to +33 | V |
| V_{SET} | SET pin voltage relative to V_{IN} pin | -5 to +0.3 | V |
| V_{SW} | SW voltage relative to GND | -0.3 to +33 | V |
| V_{CTRL} | CTRL pin input voltage | -0.3 to +6 | V |
| I_{SW} | Switch current | 1.25 | A |
| T_J | Junction Temperature | 150 | $^\circ C$ |
| T_{LEAD} | Lead Temperature Soldering | 300 | $^\circ C$ |
| T_{ST} | Storage Temperature Range | -55 to +150 | $^\circ C$ |

Caution: Stresses greater than the 'Absolute Maximum Ratings' specified above, may cause permanent damage to the device. These are stress ratings only; functional operation of the device at these or any other conditions exceeding those indicated in this specification is not implied. Device reliability may be affected by exposure to absolute maximum rating conditions for extended periods of time.
Semiconductor devices are ESD sensitive and may be damaged by exposure to ESD events. Suitable ESD precautions should be taken when handling and transporting these devices.

Recommended Operating Conditions (@ $T_A = +25^\circ\text{C}$, unless otherwise specified.)

| Symbol | Parameter | Min | Max | Unit |
|--------------|--|-----|------|------------------|
| V_{IN} | Operating Input Voltage Relative to GND | 6.0 | 30 | V |
| V_{CTRLH} | Voltage High for PWM Dimming Relative to GND | 2.6 | 5.5 | V |
| V_{CTRLDC} | Voltage Range for 20% to 100% DC Dimming Relative to GND | 0.5 | 2.5 | V |
| V_{CTRLLL} | Voltage Low for PWM Dimming Relative to GND | 0 | 0.4 | V |
| I_{SW} | Continuous Switch Current (Note 4) | | 1 | A |
| f_{SW} | Maximum Switching Frequency | | 1 | MHz |
| T_J | Junction Temperature Range | -40 | +125 | $^\circ\text{C}$ |

Note: 4. Subject to ambient temperature, input voltage and switching frequency. See applications section for suggested derating.

Electrical Characteristics (@ $T_A = +25^\circ\text{C}$, $V_{IN} = 12\text{V}$, CTRL pin floating; unless otherwise specified.)

| Symbol | Parameter | Conditions | Min | Typ | Max | Unit |
|----------------|---|---|-----|----------|-----|--------------------|
| V_{INSU} | Internal Regulator Start Up Voltage | V_{IN} rising | | 5.6 | | V |
| V_{INSH} | Internal Regulator Hysteresis Threshold | V_{IN} falling | | 200 | | mV |
| I_Q | Quiescent Current | $V_{IN} = 30\text{V}$, output not switching | | 350 | | μA |
| I_S | Input Supply Current | $f_{SW} = 250\text{kHz}$ | | 450 | | μA |
| V_{TH} | Set Current Threshold Voltage | | 95 | 100 | 105 | mV |
| V_{TH-H} | Set Threshold Hysteresis | | | ± 20 | | mV |
| I_{SET} | SET Pin Input Current | $V_{SET} = V_{IN} - 0.1$ | | 16 | | μA |
| V_{CTRL} | Open Circuit CTRL Pin Voltage | | | 5 | | V |
| R_{CTRL} | CTRL Pin Input Resistance | Referred to internal 5V regulator. | | 50 | | k Ω |
| V_{REF} | Internal Reference Voltage | | | 2.5 | | V |
| $R_{DS(on)}$ | On Resistance of SW MOSFET | $I_{SW} = 0.35\text{A}$ | | 0.35 | | Ω |
| I_{SW_Lkg} | Switch Leakage Current | $V_{IN} = 30\text{V}$, $V_{CTRL} = 0.4\text{V}$, $V_{SENSE} = 0\text{V}$ | | | 0.5 | μA |
| t_R | SW Rise Time | $V_{SENSE} = 100 \pm 20\text{mV}$, $f_{SW} = 250\text{kHz}$ | | 7 | | ns |
| t_F | SW Fall Time | $V_{SW} = 0.1\text{V to } 12\text{V to } 0.1\text{V}$, $C_L = 15\text{pF}$ | | 5 | | ns |
| T_{OTP} | Over-Temperature Shutdown | | | 145 | | $^\circ\text{C}$ |
| $T_{OTP-Hyst}$ | Over-Temperature Hysteresis | | | 10 | | $^\circ\text{C}$ |
| θ_{JA} | Thermal Resistance Junction-to-Ambient | TSOT25 (Note 5) | | 209 | | $^\circ\text{C/W}$ |
| θ_{JL} | Thermal Resistance Junction-to-Lead | TSOT25 (Note 5) | | 57 | | |
| θ_{JT} | Thermal Resistance Junction-to-Top | TSOT25 (Note 5) | | 13 | | |

Notes: 5. Device mounted on FR-4 PCB (25mm x 25mm 1oz copper, minimum recommended pad layout on top layer and thermal vias to maximum area bottom layer ground plane. For better thermal performance, larger copper pad for heat-sink is needed. ...Refer to Figure 42 for the device derating curve.

Typical Performance Characteristics (@ $T_A = +25^\circ\text{C}$, unless otherwise stated.)

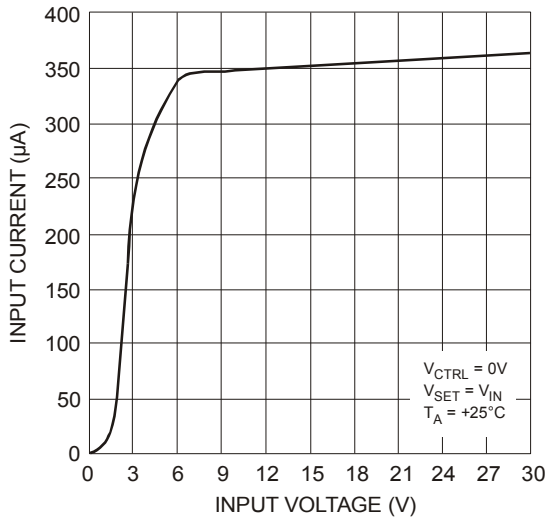

Figure 2. Supply Current vs. Input Voltage

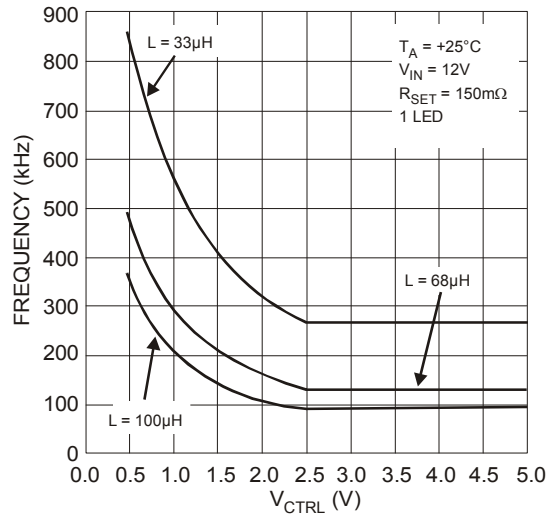

Figure 3. Switching Frequency vs. V_{CTRL}

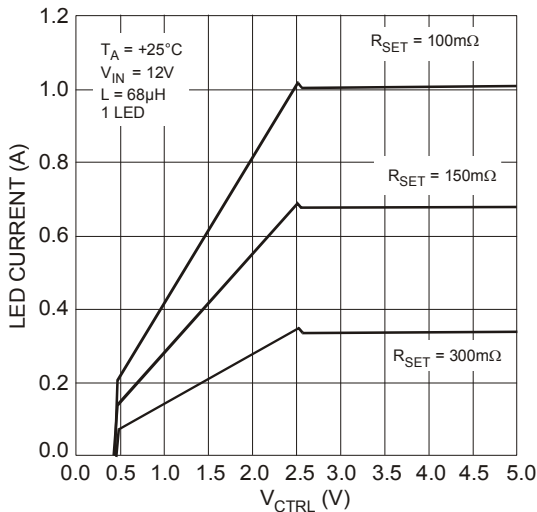

Figure 4. LED Current vs. V_{CTRL}

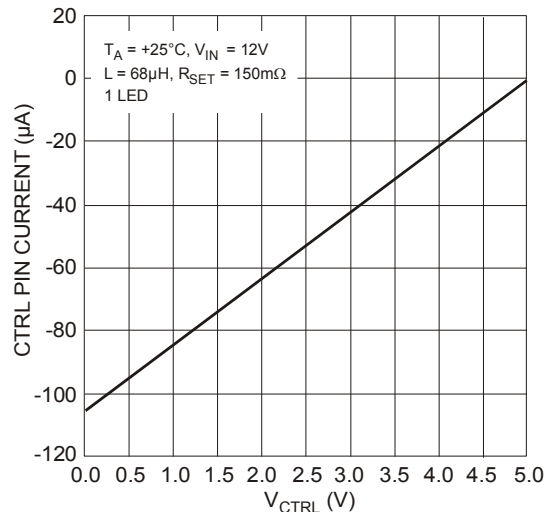

Figure 5. I_{CTRL} vs. V_{CTRL}

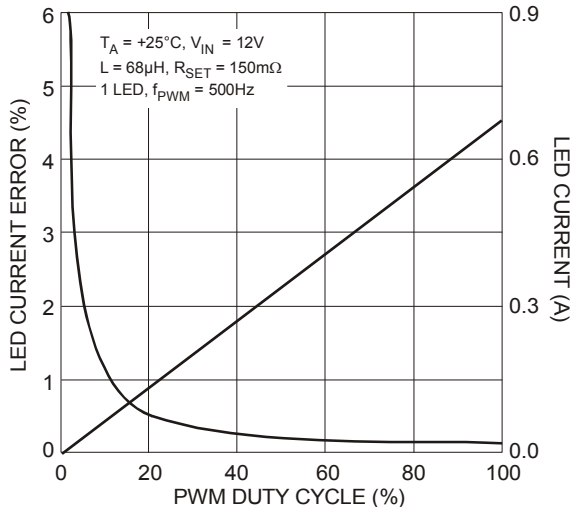

Figure 6. I_{LED} vs. PWM Duty Cycle

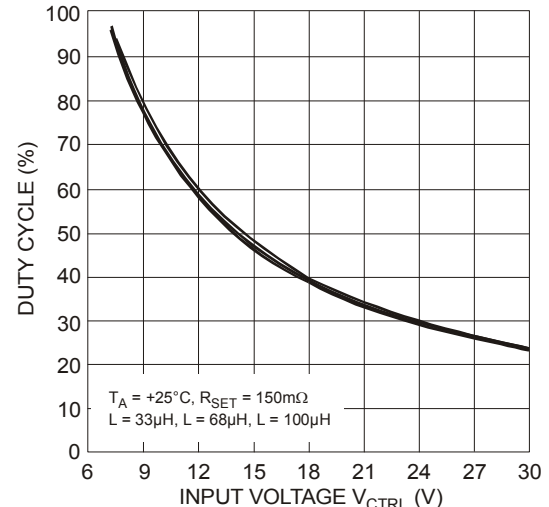
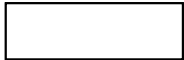

Figure 7. Duty Cycle vs. Input Voltage



Typical Performance Characteristics (cont.) (@ $T_A = +25^\circ\text{C}$, unless otherwise stated.)

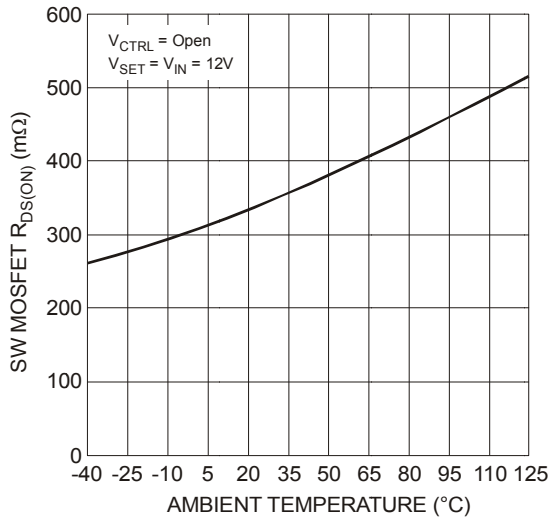

Figure 8. SW $R_{DS(ON)}$ vs. Temperature

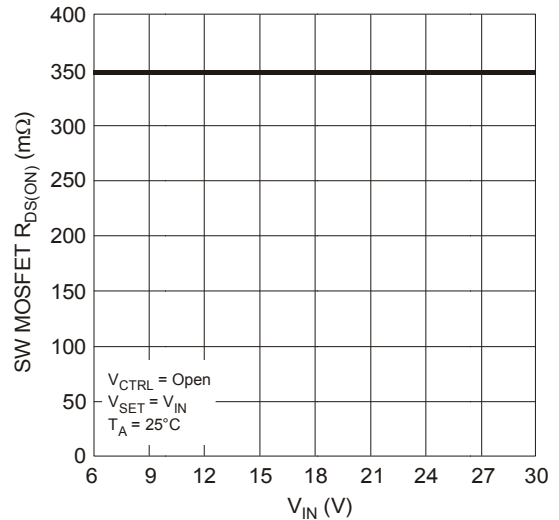

Figure 9. SW $R_{DS(ON)}$ vs. Input Voltage

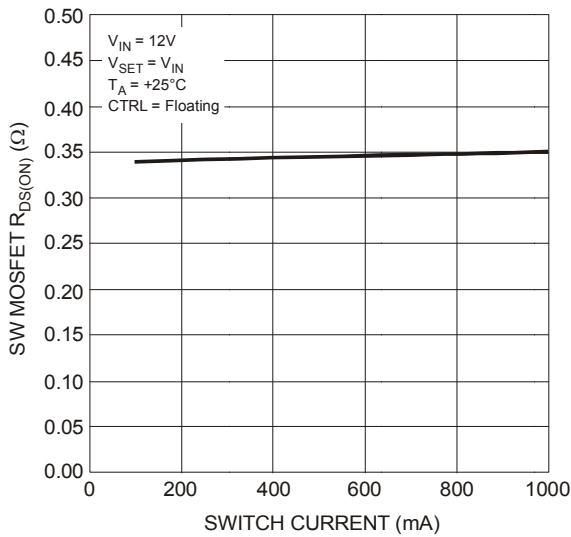

Figure 10. SW $R_{DS(ON)}$ vs. Switch Current

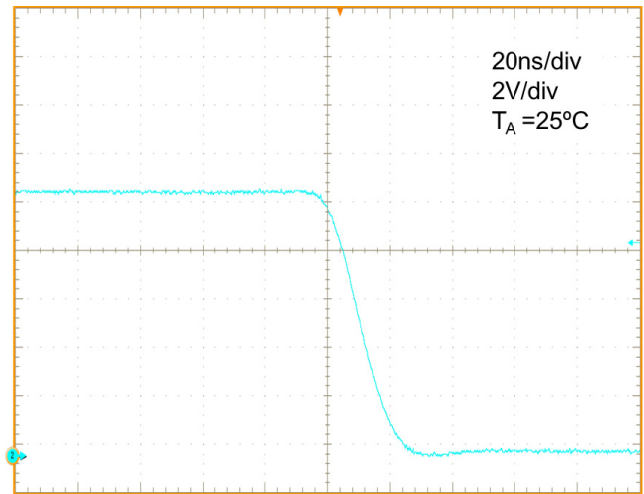

Figure 11. SW Output Fall Time

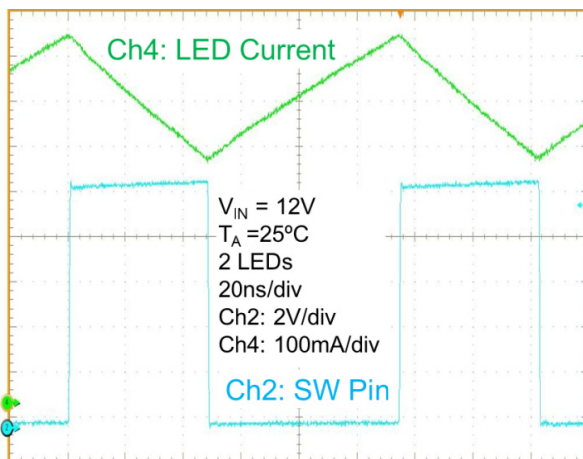

Figure 12. Steady State Waveforms

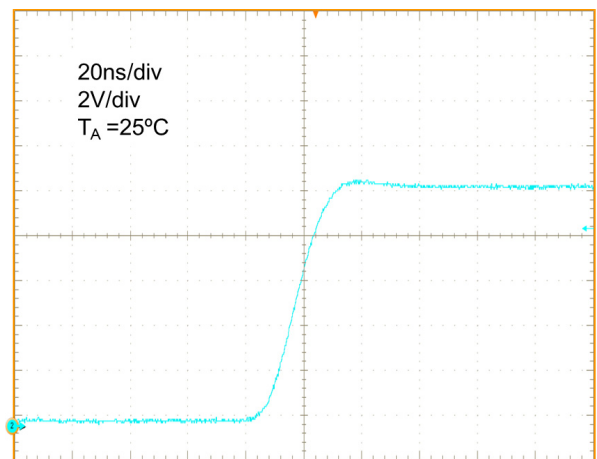

Figure 13. SW Output Rise Time

Typical Performance Characteristics ($L = 68\mu\text{H}$, $T_A = +25^\circ\text{C}$, unless otherwise stated.)

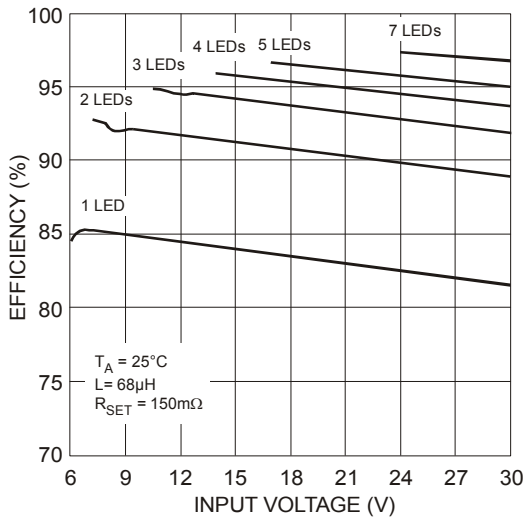

Figure 14. Efficiency vs. Input Voltage

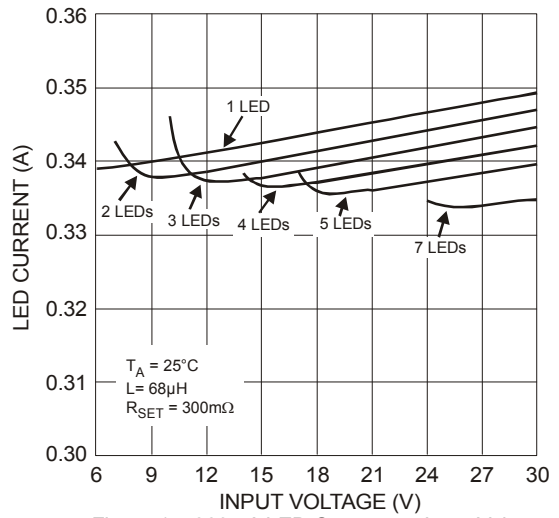

Figure 15. 330mA LED Current vs. Input Voltage

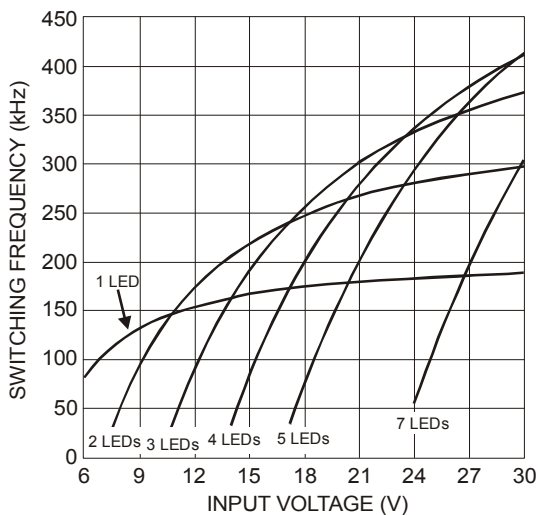

Figure 16. Switching Frequency vs. Input Voltage

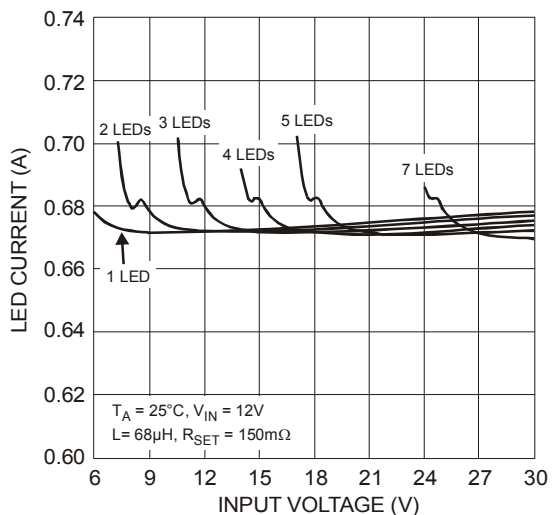

Figure 17. 670mA LED Current vs. Input Voltage

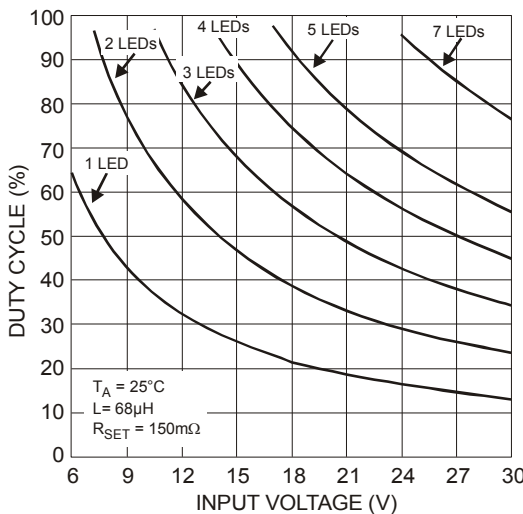

Figure 18. Duty Cycle vs. Input Voltage

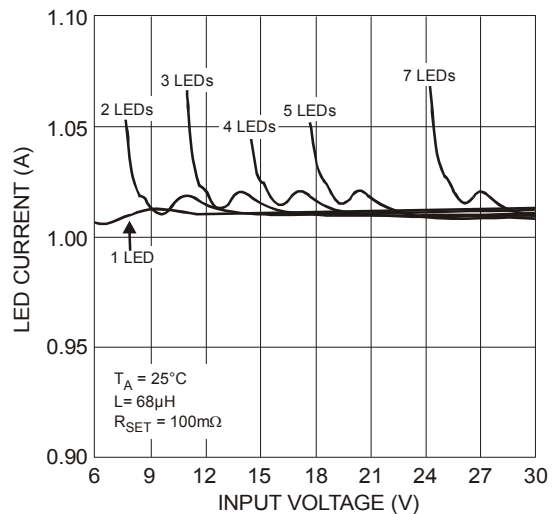

Figure 19. 1A LED Current vs. Input Voltage

Typical Performance Characteristics (670mA LED Current; $T_A = +25^\circ\text{C}$ unless otherwise stated.)

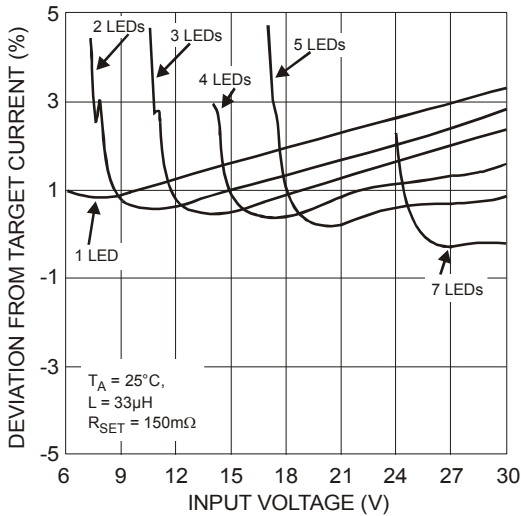

Figure 20. LED Current Deviation vs. Input Voltage

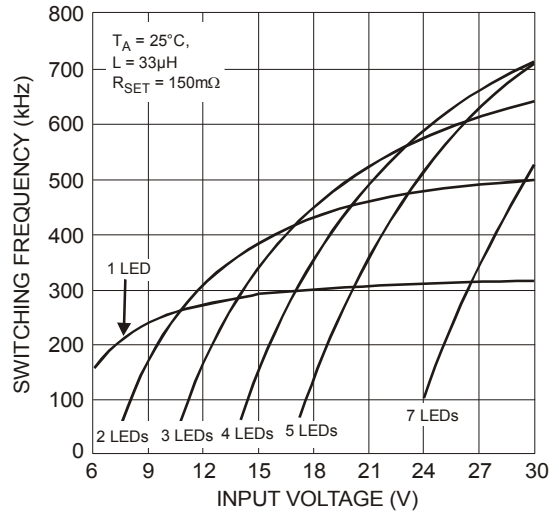

Figure 21. Switching Frequency vs. Input Voltage

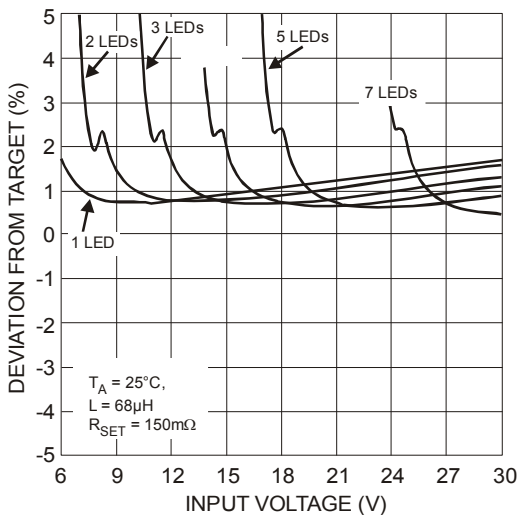

Figure 22. LED Current Deviation vs. Input Voltage

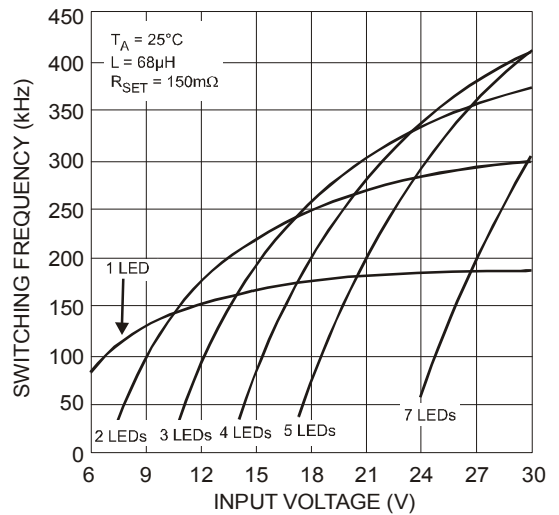

Figure 23. Switching Frequency vs. Input Voltage

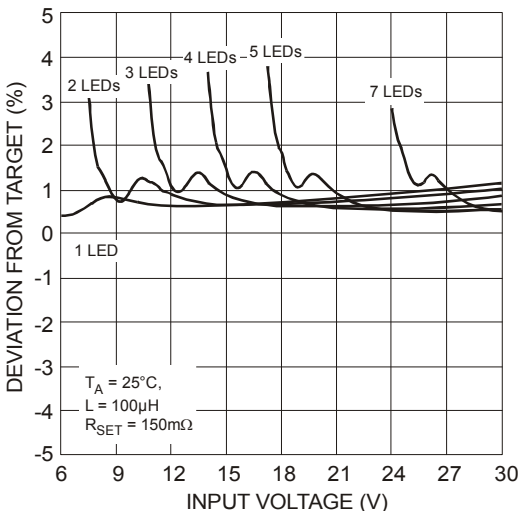

Figure 24. LED Current Deviation vs. Input Voltage

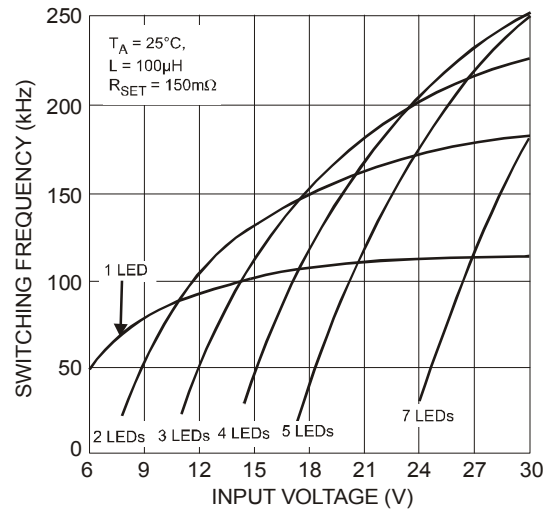

Figure 25. Switching Frequency vs. Input Voltage

Typical Performance Characteristics (1A LED Current) $T_A = +25^\circ\text{C}$ unless otherwise stated.)

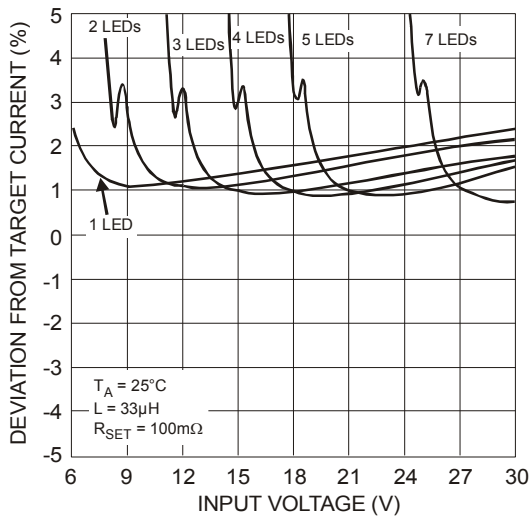

Figure 26. LED Current Deviation vs. Input Voltage

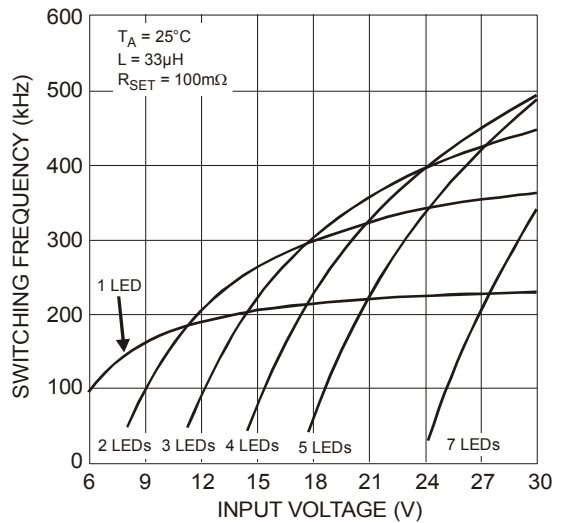

Figure 27. Switching Frequency vs. Input Voltage

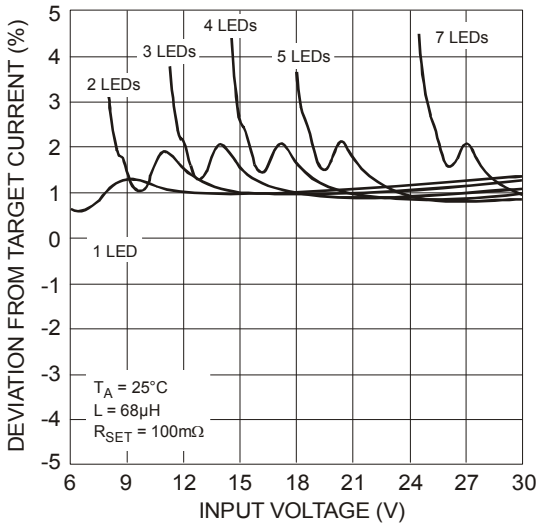

Figure 28. LED Current Deviation vs. Input Voltage

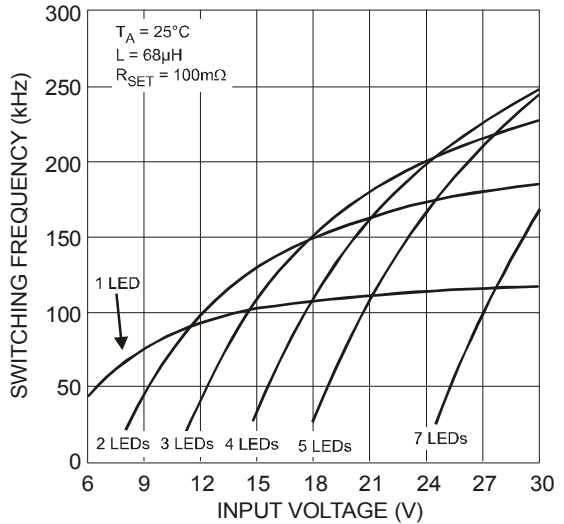

Figure 29. Switching Frequency vs. Input Voltage

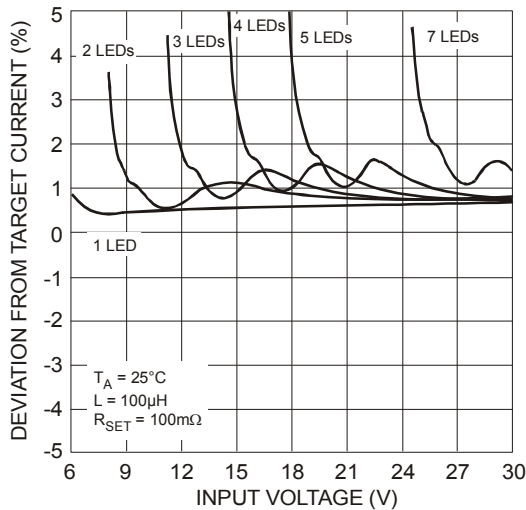

Figure 30. LED Current Deviation vs. Input Voltage

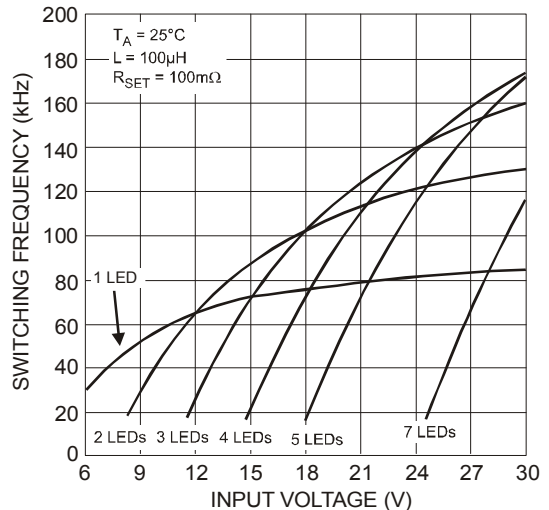

Figure 31. Switching Frequency vs. Input Voltage

Application Information

AL8808 Operation

In normal operation, when voltage is applied at +V_{IN}, the AL8808 internal switch is turned on. Current starts to flow through sense resistor R1, inductor L1, and the LEDs. The current ramps up linearly, and the ramp rate is determined by the input voltage (+V_{IN}) minus the LED chain voltage and the inductor L1.

This rising current produces a voltage ramp across R1. The internal circuit of the AL8808 senses the voltage across R1 and applies a proportional voltage to the input of the internal comparator.

When this voltage reaches an internally set upper threshold, the internal switch is turned off. The inductor current continues to flow through R1, L1, the LEDs and the schottky diode D1, and back to the supply rail, but it decays, with the rate of decay determined by the forward voltage drop of the LEDs and the schottky diode.

This decaying current produces a falling voltage at R1, which is sensed by the AL8808. A voltage proportional to the sense voltage across R1 is applied at the input of the internal comparator. When this voltage falls to the internally set lower threshold, the internal switch is turned on again. This switch-on-and-off cycle continues to provide the average LED current set by the sense resistor R1.

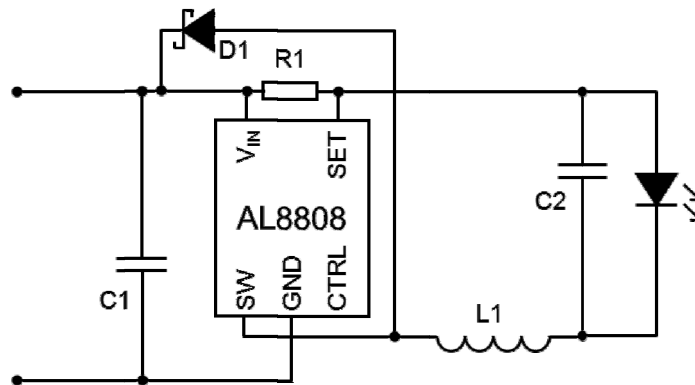

Figure 32. Typical Application Circuit

LED Current Control

The LED current is controlled by the resistor R₁ (in Figure 32) connected between V_{IN} and SET pins. The AL8808 has an internal 50k resistor connected from the CTRL pin to an internal 5V regulator. When the CTRL pin is left floating it gets pulled up to 5V - increasing its noise rejection with CTRL left floating. If the CTRL pin is left floating or driven above 2.5V the nominal average output current in the LED(s) is defined as:

$$I_{LED} = \frac{V_{TH}}{R1}$$

Where V_{TH} is nominally 100mV.

If the CTRL pin is driven by an external voltage (higher than 0.5V and lower than 2.5V), the average LED current is:

$$I_{LED} = \frac{V_{CTRL}}{V_{REF}} \frac{V_{TH}}{R1}$$

Where V_{REF} is nominally 2.5V

For example for a desired LED current of 660mA and V_{CTRL}=2.5V or with the CTRL pin left open the resulting resistor is:

$$R_{SET} = \frac{V_{TH}}{I_{LED}} = \frac{0.1}{0.66} \approx 150m\Omega$$

When the CTRL voltage is brought below 0.4V, the output switch is turned off which allows PWM dimming.

Application Information (cont.)

Analog Dimming

The CTRL pin can be driven by an external analog voltage (V_{CTRL}), to adjust the output current to a value below the nominal average value defined by R1. The LED current decreases linearly with the CTRL voltage when $0.5V \leq V_{CTRL} \leq 2.5V$.

Note that 100% brightness is achieved when either the CTRL pin is left floating or pulled above 2.5V by an external voltage source.

For $2.6V \leq V_{CTRL} \leq 5.5V$ the LED current will not get overdriven and will be set the current according to the equation $V_{CTRL} = 2.5V$ (the internal reference voltage). See Figure 33 below.

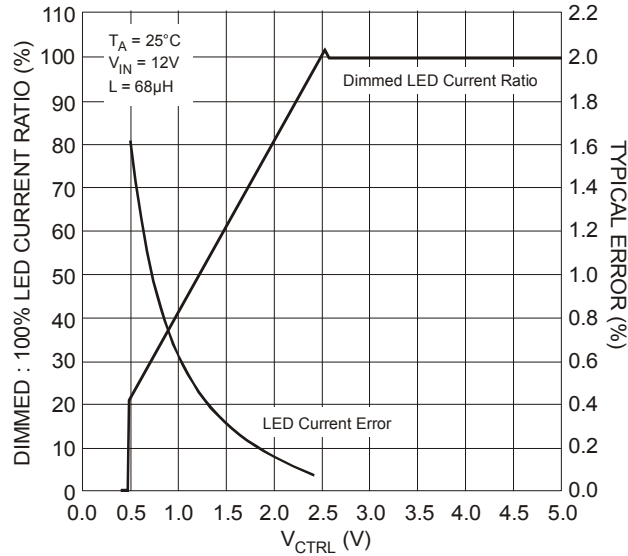

Figure 33. LED Current Dimming Ratio and Typical Error vs. Control Voltage

PWM Dimming

LED current can be adjusted digitally, by applying a low frequency Pulse Width Modulated (PWM) logic signal to the CTRL pin to turn the device on and off. This will produce an average output current proportional to the duty cycle of the control signal. In particular, a PWM signal with a max resolution of 10bit (~0.1% duty cycle) can be applied to the CTRL pin to change the output current to a value below the nominal average value set by resistor R_{SET} . To achieve this resolution the PWM frequency has to be lower than 500Hz, however higher dimming frequencies can be used, at the expense of dimming dynamic range and accuracy.

Typically, for a PWM frequency of 500Hz the accuracy is better than 2% for PWM ranging from 5% to 100%.

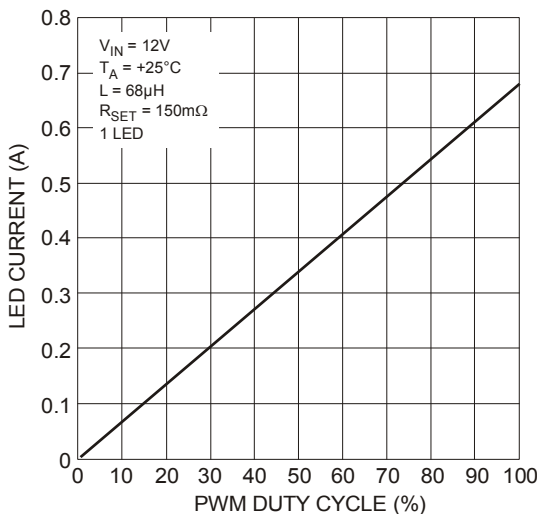

Figure 34. PWM Dimming at 500Hz

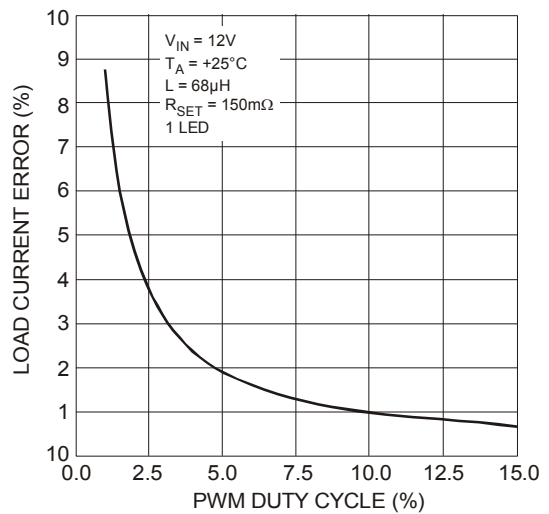
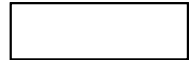

Figure 35. Low Duty Cycle PWM Dimming at 500Hz



Application Information (cont.)

PWM Dimming (cont.)

The CTRL pin is designed to be driven by both 3.3V and 5V logic levels directly from a logic output with either an open drain output or push pull output stage.

The ultimate PWM dimming resolution is determined by the number of full LED switching cycles that can be achieved during the PWM on-time. At lower switching frequencies and/or higher PWM frequencies the number of full switching cycles that can be achieved is reduced thereby reducing the accuracy/linearity of the PWM dimming.

At the start of each PWM cycle the LED current needs to restart from zero up to the upper threshold level (nominally $120\text{mV}/R_{\text{SET}}$). If this threshold isn't reached then the accuracy will be greatly affected.

Greater PWM dimming dynamic ranges can be achieved by reducing the PWM dimming frequency and/or increasing the AL8808 switching frequency.

The three figures below show 0.2% duty cycle PWM pulse resolution with different PWM frequencies and different inductor values driving 2 LEDs from a 12V rail at +25°C for a nominal LED current of 670mA.

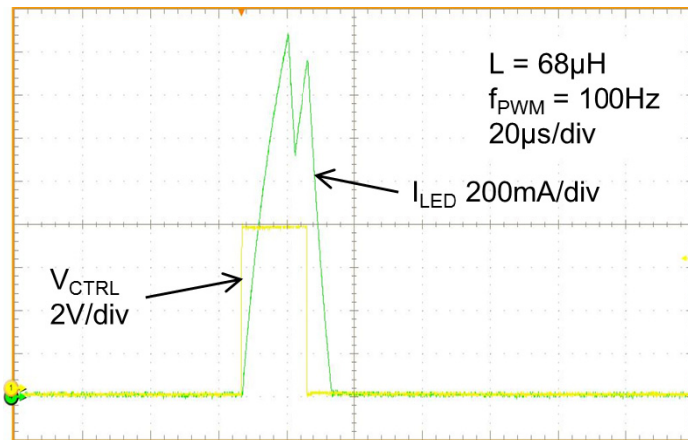

Figure 36. 0.2% PWM Duty Cycle at 100Hz PWM Frequency and 68µH Inductance

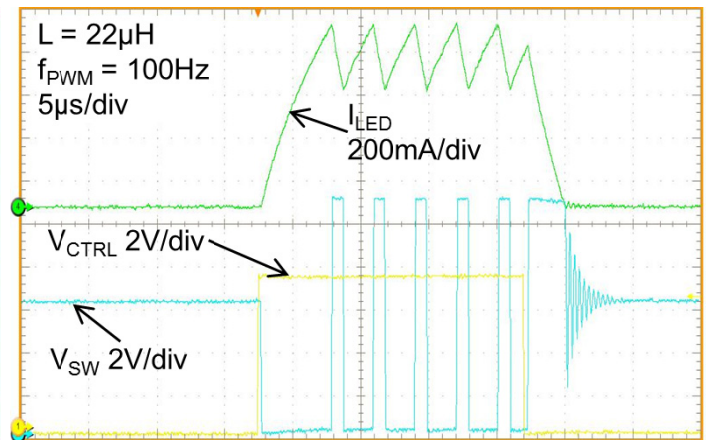

Figure 37. 0.2% PWM Duty Cycle at 100Hz PWM Frequency and 22µH Inductance

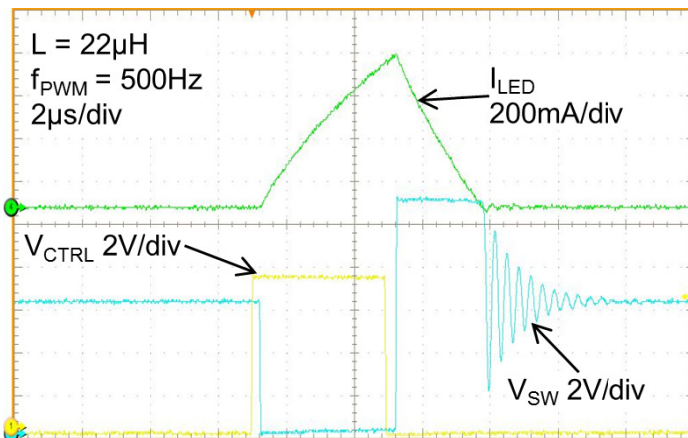
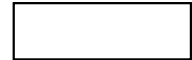

Figure 38. 0.2% PWM Duty Cycle at 500Hz PWM Frequency and 22µH Inductance

As can be observed from Figure 37 greater dimming accuracy can be achieved by reducing both the PWM dimming frequency and the inductor value.



Application Information (cont.)

Start-up and Soft Start

On initial power up the device will not start switching until the power supply has reached approximately 5.6V or the CTRL pin voltage is greater than 0.45V (typical). This causes a slight delay (dependent on ramp rate of input voltage and input bulk capacitance of the AL8808 circuit). Once the output starts switching the LED current will build up to the upper threshold level:

$$I_{LEDSSPK} = \frac{V_{CTRL}}{2.5V} \frac{0.1 \times 1.2}{R1}$$

This will cause some additional input current to that of charging the input bulk capacitance. One way of reducing this additional current is to reduce the upper LED current threshold level by slowing down the rise of the CTRL pin voltage – implementing a soft-start.

The AL8808 does not have in-built soft-start action allowing very fast control of the output Power MOSFET switch which improves PWM dimming accuracy.

Soft start can be easily implemented by adding an external capacitor from the CTRL pin to ground. The internal pull-up resistor to the internal 5V rail on the CTRL pin will charge the external capacitor up to 5V.

The external capacitor slows up the ramp-up of the CTRL pin voltage thereby reducing the LED current via analog dimming. To ensure soft-start occurs it is essential that the capacitor is large enough to keep the CTRL pin voltage below 2.5V during the ramp-up of the input voltage.

This is achieved by increasing the time taken for the CTRL voltage to rise to the upper (turn-off) threshold and by slowing down the rate of rise of the control voltage at the input of the comparator.

Adding this capacitor increases the time taken for the output to reach 90% of its final value, this delay is 25µs/nF, but will impact on the PWM dimming accuracy depending on the delay introduced.

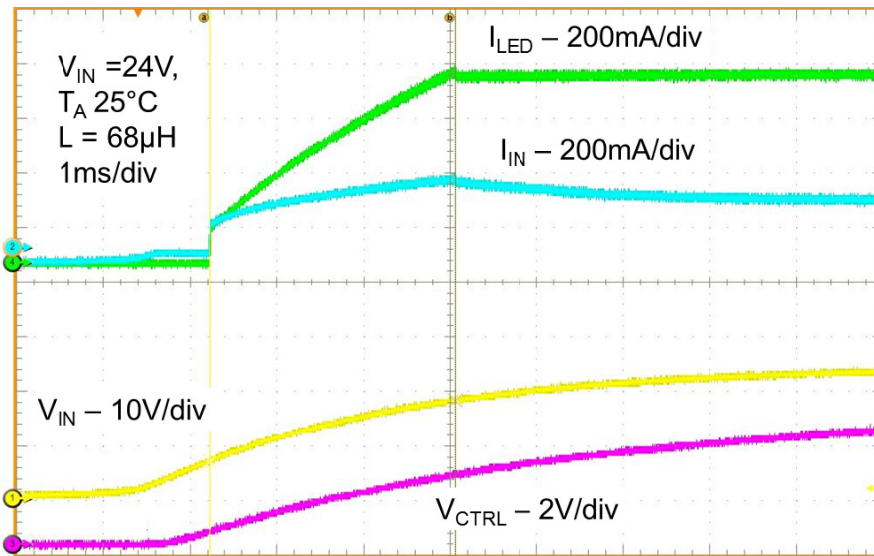

Figure 39. Soft Start with 100nF Capacitor on CTRL pin ($V_{IN} = 24V$, $I_{LED} = 667mA$, 1 LED)

Reducing Output Ripple

Peak to peak ripple current in the LED(s) can be reduced, if required, by shunting a capacitor C2 across the LED(s) as shown in Figure 32. A value of 1µF will reduce the supply ripple current significantly in the typical case. Proportionally lower ripple can be achieved with higher capacitor values.

Note that the capacitor will not affect operating frequency or efficiency, but it will increase start-up delay, by reducing the rate of rise of LED voltage. By adding this capacitor the current waveform through the LED(s) changes from a triangular ramp to a more sinusoidal version without altering the mean current value.

Application Information (cont.)

Inductor Selection

Recommended inductor values for the AL8808 are in the range 33µH to 100µH. Note that the AL8808 Web Calculator provides performance data for selected component values. The inductance used will depend on a combination of Input voltage and LED chain voltage to set the required switching frequency. Lower inductor values can be used to increase the switching frequency and reduce solution size but may affect LED current accuracy (due to propagation delays) and increase power dissipation (due to switching losses).

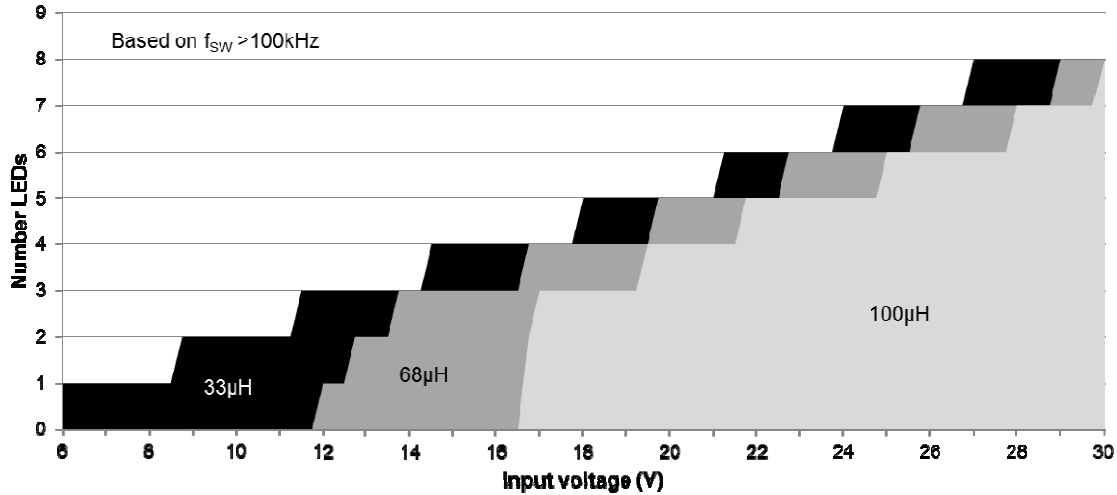

Figure 40. Inductor Value with Input Voltage and Number of LEDs

The inductor should be mounted as close to the device as possible with low resistance/stray inductance connections to the SW pin. The chosen coil should have a saturation current higher than the peak output current and a continuous current rating above the required mean output current.

Suitable coils for use with the AL8807 are listed in the table below:

| Part No. | L (µH) | DCR (V) | ISAT (A) | Manufacturer |
|----------------|--------|---------|----------|--|
| MSS1038-333 | 33 | 0.093 | 2.3 | CoilCraft www.coilcraft.com |
| MSS1038-683 | 68 | 0.213 | 1.5 | |
| NPIS64D330MTRF | 33 | 0.124 | 1.1 | NIC www.niccomp.com |

The inductor value should be chosen to maintain operating duty cycle and switch 'on'/'off' times over the supply voltage and load current range. The following equations can be used as a guide, with reference to Figure 1 - Operating waveforms.

Switch 'On' time:

$$t_{ON} = \frac{L \Delta I}{V_{IN} - V_{LED} - I_{AVG} \times (R_S + r_L + R_{SW})}$$

Switch 'Off' time:

$$t_{OFF} = \frac{L \Delta I}{V_{LED} + V_D + I_{AVG} \times (R_S + r_L)}$$

Where:

- L is the coil inductance (H)
- r_L is the coil resistance (Ω)
- R_S is the current sense resistance (Ω)
- I_{avg} is the required LED current (A)
- V_{IN} is the supply voltage (V)
- ΔI is the coil peak-peak ripple current (A) {Internally set to 0.4 x I_{AVG}}
- V_{LED} is the total LED forward voltage (V)
- R_{SW} is the switch resistance (Ω) {=0.35Ω nominal}
- V_D is the diode forward voltage at the required load current (V)

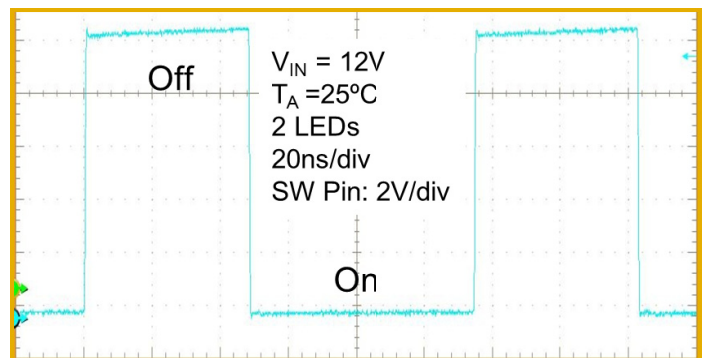

Figure 41. Typical Switching Waveform

Application Information (cont.)

Capacitor Selection

The small size of ceramic capacitors makes them ideal for AL8808 applications. X7R type is recommended because it retains capacitance value over wider voltage and temperature ranges than other types such as Y5V or Z5U. X5R is a useful compromise over a restricted temperature range. Note that even X7R capacitance reduces significantly with increased DC bias voltage. At 50% of rated voltage, the capacitance loss is between about 10% to 50% of nominal. Therefore it is often necessary to select a voltage rating which is at least twice the operating voltage.

Input Capacitor

In Figure 32, the input capacitor C1 is required as a reservoir. Diode D1 switches at a rate of typically up to 400kHz. The power supply has a finite impedance, often including a wiring inductance value of the order of 100nH to 1uH or more depending upon the system design. C1 is required to limit the power supply voltage and current ripple both to allow stable regulation of the LED current, and also to meet EMC requirements.

A 2.2μF input capacitor is sufficient for most DC powered applications of AL8808. This depends upon the operating voltage and current and the maximum level of ripple required. Additional capacitors may be required in parallel for EMC purposes. This is described below in a separate section.

However, if operated from a rectified low voltage AC source, such as MR16, then the input capacitance will need to be significantly increased to provide enough reservoir charge when the input voltage falls below the minimum operating voltage of the AL8808 or the LED chain voltage

Output Capacitor

In Figure 32, the output capacitor C2 is normally required to limit the load voltage and current ripple, in order to meet EMC requirements. A value of 0.1μF to 1μF is sufficient for many requirements, depending on voltage and current conditions. Additional capacitors may be required in parallel for EMC purposes. This is described below in a separate section.

Diode Selection

For maximum efficiency and performance, the flywheel rectifier (D1) should be a fast low capacitance Schottky diode with low reverse leakage at the maximum operating voltage and temperature. The silicon PN diode is not suitable because of its increased power loss, due to a combination of lower forward voltage and reduced recovery time. The use of a Super-Barrier-Rectifier (SBR) is not recommended for use as a flywheel diode in this application. (However the SBR provides significant advantages when used with an AC power input as a bridge rectifier driving V_{IN} .)

It is important to select D1 with a peak current rating above the peak coil current and a continuous current rating higher than the maximum output load current. In particular, it is recommended to have a diode voltage rating at least 15% higher than V_{IN} to ensure safe operation during the switching and a mean current rating at least 10% higher than the peak diode current. The power rating is verified by calculating the power loss through the diode. In practice, the voltage rating selection is often increased by up to about 50% to obtain a better compromise with loss due to reverse leakage current at higher temperature. Also the current rating is typically selected to provide a margin of up to about 50%.

Schottky diodes, e.g. DFSL240L or DFSL140, with their low forward voltage drop and fast reverse recovery, are the ideal choice for AL8808 applications. Leakage current is sufficiently limited for the application.

Application Information (cont.)

Thermal Considerations

For continuous conduction mode of operation, the absolute maximum junction temperature must not be exceeded. The maximum power dissipation depends on several factors: the thermal resistance of the IC package (θ_{JC}), PCB layout, airflow surrounding the IC, and difference between junction and ambient temperature.

The maximum power dissipation can be calculated using the following formula:

$$P_{D(MAX)} = \frac{T_{J(MAX)} - T_A}{\theta_{JA}}$$

where

$T_{J(MAX)}$ is the maximum operating junction temperature; for the AL8808 this is +125°C.

T_A is the ambient temperature, and

θ_{JA} is the junction to ambient thermal resistance.

The major thermal path for the TSOT25 package is pin 2 (GND pin) and it is important for minimizing the θ_{JA} that a suitable area and thermal mass is associated with pin 2. The thermal impedance from the AL8808 junction to pin 2 is approximately 57°C/W.

The AL8808's θ_{JA} on a 25 x 25mm double sided FR4 PCB with minimum recommended pad layout on top layer and thermal vias to maximum area on bottom layer with 1oz copper standing in still air is approximately 209°C/W. Yielding a maximum power dissipation at 25°C of 0.47W

The AL8808's θ_{JA} on a 25 x 25mm double sided FR4 PCB with maximum area top and bottom with vias is approximately 151°C/W; which gives a maximum power dissipation at 25°C of 0.66W.

Figure 42 shows the power derating of the AL8808 on different area PCB with maximum area on bottom of PCB with 1 and 2oz copper standing in still air.

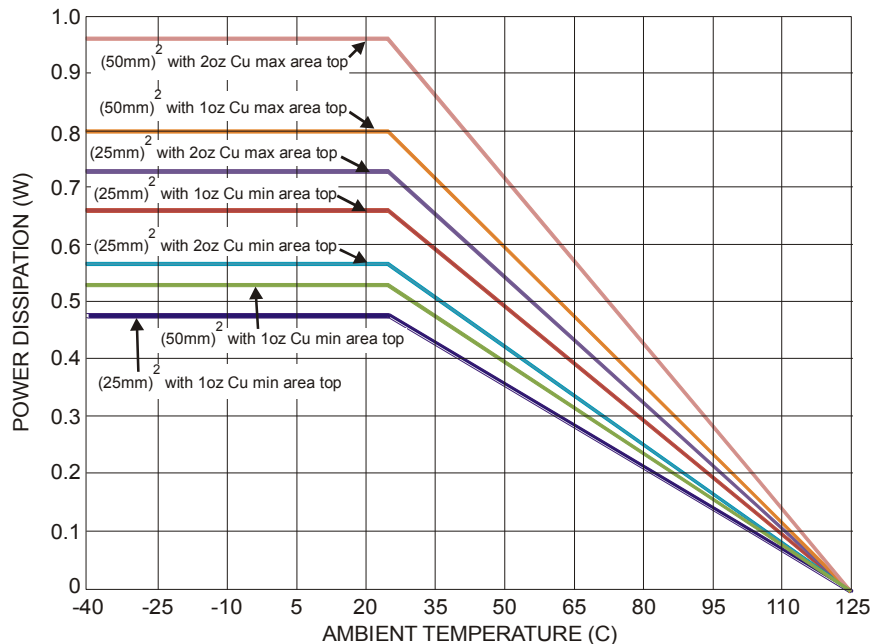

Figure 42. Derating Curve for Different PCB

Application Information (cont.)

EMI and Layout Considerations

The AL8808 is a switching regulator with fast edges and measures small differential voltages; as a result of this care has to be taken with decoupling and layout of the PCB. To help with these effects the AL8808 has been developed to minimise radiated emissions by controlling the switching speeds of the internal power MOSFET. The rise and fall times are controlled to get the right compromise between power dissipation due to switching losses and radiated EMI.

The turn-on edge (falling edge) dominates the radiated EMI which is due to an interaction between the Schottky diode (D1), Switching MOSFET and PCB tracks. After the Schottky diode reverse recovery time of around 5ns has occurred; the falling edge of the SW pin sees a resonant loop between the Schottky diode capacitance and the track inductance, L_{TRACK} , See Figure 43.

The tracks from the SW pin to the Anode of the Schottky diode, D1, and then from D1's cathode to the decoupling capacitors C1 should be as short as possible.

There is an inductance internally in the AL8808 this can be assumed to be around 1nH. For PCB tracks a figure of 0.5nH per mm can be used to estimate the primary resonant frequency. If the track is capable of handling 1A increasing the thickness will have a minor effect on the inductance and length will dominate the size of the inductance.

The resonant frequency of any oscillation is determined by the combined inductance in the track and the effective capacitance of the Schottky diode. An example of good layout is shown in Figure 44 - the stray track inductance should be less than 5nH.

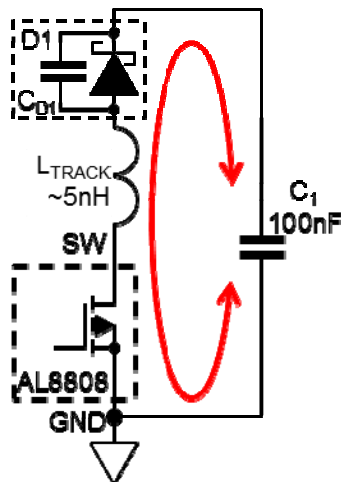

Figure 43. PCB Loop Resonance

Figure 44. Recommended PCB Layout

Summary:

1. Use a PCB construction with copper foil on top and bottom. Provide maximum coverage of copper ground plane on both sides. Ensure the ground areas are tightly connected together using plated via holes placed at regular intervals. This is required both for low EMI (EMC) operation and also to minimize device temperatures by spreading the dissipated heat.
2. Place capacitor C1 as close as possible to V_{IN} , and as close as possible to the cathode of D1. The separation of these nodes should be less than about 5mm. To ensure the best possible EMI filtering (greatest attenuation), place the capacitor and its copper trace such that the input current passes directly through the capacitor mounting pad. This minimizes common impedance coupling due to the added parasitic inductance of the copper trace. Ensure low inductance connection between the capacitor and its ground connection. Use 2 or more ground via holes close to the ground pad.
3. Place sense resistor R1 as close as possible to V_{IN} and SET.
4. Place D1 anode, the SW pin and the inductor as close together as possible to avoid ringing.
5. Place capacitor C2 as close as possible to L1 and SET. To ensure the best possible EMI filtering (greatest attenuation), place the capacitor and its copper trace such that the input current passes directly through the capacitor mounting pad. This minimizes common impedance coupling due to the added parasitic inductance of the copper trace.

Application Information (cont.)

EMI and Layout Considerations (cont.)**EMC Design**

In addition to the layout instructions above, it may be necessary to take further measures to reduce electromagnetic interference (EMI) and meet EMC requirements. This depends on the speed of the switching transitions. The fast switching edges include spectral harmonics spreading into the UHF frequency range towards 500MHz. In this respect, AL8808 has been optimized to shape the switching current waveform to minimize EMI while maintaining fast enough switching for high power efficiency. However, depending on the physical system design it may be necessary to add additional filtering to reduce radiated and conducted emissions. The required circuit changes depend on a number of system design aspects including the PCB size, the housing design and the length of external connecting wires.

Radiated Emission

Typically, the filtering required to control radiated emission consists of one or two additional capacitors placed close to the connecting points of the wires. Very often the frequency range requiring most attenuation is in the region of 100MHz to 500MHz. In order to provide best attenuation in this frequency range, use a capacitor of 1000pF to 2200pF with COG dielectric type, rated 50V or 100V. This capacitor provides very low ESR in this frequency range. Place two such capacitors, one near the V_{IN} wire connection and one near the output connection to L1. Again, to ensure the best possible EMI filtering (greatest attenuation), place the capacitor and its copper trace such that the input or output current passes directly through the capacitor mounting pad. This minimizes common impedance coupling due to the added parasitic inductance of the copper trace.

Conducted Emission

Conducted emission limits sometimes require filtering in the lower frequency range, from the switching frequency itself (Typically 200kHz) up to about 30MHz. Usually the requirement only applies on the input side. The existing power supply may already include suitable measures. If necessary add an input capacitor to reduce the ripple in this frequency range. Again the capacitors and their copper traces should be carefully placed to avoid inductive common impedance coupling. Sometimes an additional series filter inductor may be added to achieve the desired attenuation. An additional shunt capacitor to ground is connected resulting in a pi-filter configuration.

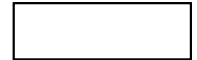

Application Information (cont.)

Fault Condition Operation

The AL8808 has by default open LED protection. If the LEDs should become open circuit the AL8808 will stop oscillating; the SET pin will rise to V_{IN} and the SW pin will then fall to GND. No excessive voltages will be seen by the AL8808.

If the LEDs should become shorted together the AL8808 will continue to switch and the current through the AL8808's internal switch will still be at the expected current - so no excessive heat will be generated within the AL8808. However, the duty cycle at which it operates will change dramatically and the switching frequency will most likely decrease. See Figure 45 for an example of this behavior at 24V input voltage driving 3 LEDs.

The on-time of the internal power MOSFET switch is significantly reduced because almost all of the input voltage is now developed across the inductor. The off-time is significantly increased because the reverse voltage across the inductor is now just the Schottky diode voltage (See Figure 32) causing a much slower decay in inductor current.

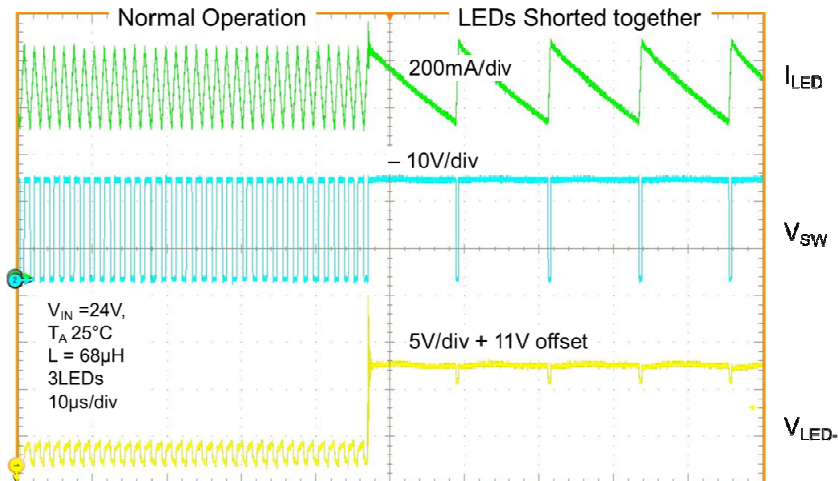

Figure 45. Switching Characteristics (normal open to short LED chain)

High Temperature Operation and Protection

The AL8808 is a high efficiency switching LED driver capable of operating junction temperatures up to +125°C. This allows it operate with ambient temperature in excess of 100°C given the correct thermal impedance to free air. If a fault should occur that leads to increased ambient temperatures and hence junction temperature then the Over-Temperature Protection (OTP) of the AL8808 will cut in turning the output of the AL8808 off. This will allow the junction temperature of the AL8808 to cool down and potentially giving an opportunity for the fault to clear itself.

The OTP shutdown junction temperature of the AL8808 is approximately +145°C with a hysteresis of +10°C. This means that the AL8808 will never switch-off with a junction temperature below +125°C allowing the designer to design the system thermally to fully utilize the wide operating junction temperature of the AL8808.

Ordering Information

AL8808 XX - XX

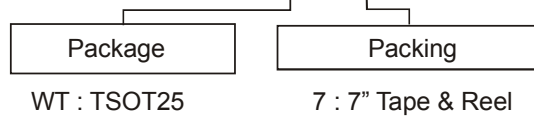

| Part Number | Package Code | Packaging | 7" Tape and Reel | |
|-------------|--------------|-----------|------------------|--------------------|
| | | | Quantity | Part Number Suffix |
| AL8808WT-7 | WT | TSOT25 | 3000/Tape & Reel | -7 |

Marking Information

TSOT25

(Top View)

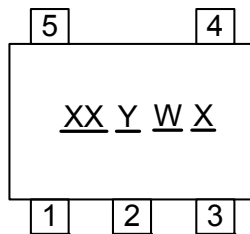

- XX : Identification code
- Y : Year 0~9
- W : Week : A~Z : 1~26 week;
a~z : 27~52 week; z represents 52 and 53 week
- X : A~Z : Internal code

| Part Number | Package | Identification Code |
|-------------|---------|---------------------|
| AL8808WT-7 | TSOT25 | B9 |

Package Outline Dimensions (All dimensions in mm.)

Please see AP02002 at <http://www.diodes.com/datasheets/ap02002.pdf> for latest version.

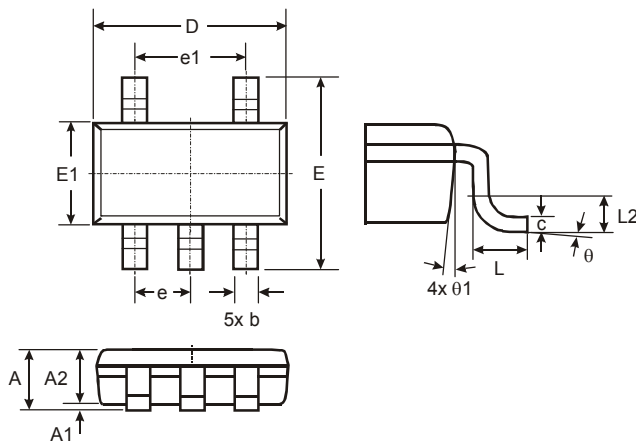

| TSOT25 | | | |
|----------------------|------|------|------|
| Dim | Min | Max | Typ |
| A | - | 1.00 | - |
| A1 | 0.01 | 0.10 | - |
| A2 | 0.84 | 0.90 | - |
| D | - | - | 2.90 |
| E | - | - | 2.80 |
| E1 | - | - | 1.60 |
| b | 0.30 | 0.45 | - |
| c | 0.12 | 0.20 | - |
| e | - | - | 0.95 |
| e1 | - | - | 1.90 |
| L | 0.30 | 0.50 | - |
| L2 | - | - | 0.25 |
| θ | 0° | 8° | 4° |
| θ1 | 4° | 12° | - |
| All Dimensions in mm | | | |

Suggested Pad Layout

Please see AP02001 at <http://www.diodes.com/datasheets/ap02001.pdf> for latest version.

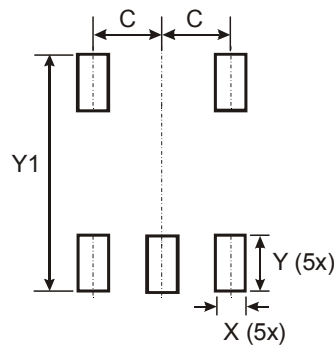

| Dimensions | Value (in mm) |
|------------|---------------|
| C | 0.950 |
| X | 0.700 |
| Y | 1.000 |
| Y1 | 3.199 |

IMPORTANT NOTICE

DIODES INCORPORATED MAKES NO WARRANTY OF ANY KIND, EXPRESS OR IMPLIED, WITH REGARDS TO THIS DOCUMENT, INCLUDING, BUT NOT LIMITED TO, THE IMPLIED WARRANTIES OF MERCHANTABILITY AND FITNESS FOR A PARTICULAR PURPOSE (AND THEIR EQUIVALENTS UNDER THE LAWS OF ANY JURISDICTION).

Diodes Incorporated and its subsidiaries reserve the right to make modifications, enhancements, improvements, corrections or other changes without further notice to this document and any product described herein. Diodes Incorporated does not assume any liability arising out of the application or use of this document or any product described herein; neither does Diodes Incorporated convey any license under its patent or trademark rights, nor the rights of others. Any Customer or user of this document or products described herein in such applications shall assume all risks of such use and will agree to hold Diodes Incorporated and all the companies whose products are represented on Diodes Incorporated website, harmless against all damages.

Diodes Incorporated does not warrant or accept any liability whatsoever in respect of any products purchased through unauthorized sales channel. Should Customers purchase or use Diodes Incorporated products for any unintended or unauthorized application, Customers shall indemnify and hold Diodes Incorporated and its representatives harmless against all claims, damages, expenses, and attorney fees arising out of, directly or indirectly, any claim of personal injury or death associated with such unintended or unauthorized application.

Products described herein may be covered by one or more United States, international or foreign patents pending. Product names and markings noted herein may also be covered by one or more United States, international or foreign trademarks.

This document is written in English but may be translated into multiple languages for reference. Only the English version of this document is the final and determinative format released by Diodes Incorporated.

LIFE SUPPORT

Diodes Incorporated products are specifically not authorized for use as critical components in life support devices or systems without the express written approval of the Chief Executive Officer of Diodes Incorporated. As used herein:

A. Life support devices or systems are devices or systems which:

1. are intended to implant into the body, or
2. support or sustain life and whose failure to perform when properly used in accordance with instructions for use provided in the labeling can be reasonably expected to result in significant injury to the user.

B. A critical component is any component in a life support device or system whose failure to perform can be reasonably expected to cause the failure of the life support device or to affect its safety or effectiveness.

Customers represent that they have all necessary expertise in the safety and regulatory ramifications of their life support devices or systems, and acknowledge and agree that they are solely responsible for all legal, regulatory and safety-related requirements concerning their products and any use of Diodes Incorporated products in such safety-critical, life support devices or systems, notwithstanding any devices- or systems-related information or support that may be provided by Diodes Incorporated. Further, Customers must fully indemnify Diodes Incorporated and its representatives against any damages arising out of the use of Diodes Incorporated products in such safety-critical, life support devices or systems.

Copyright © 2013, Diodes Incorporated

www.diodes.com

Mouser Electronics

Authorized Distributor

Click to View Pricing, Inventory, Delivery & Lifecycle Information:

[Diodes Incorporated:](#)

[AL8808WT-7](#)