

38 mm sq.

San Ace 38



General Specifications

- Material Frame: Plastics (Flammability: UL94V-0),
Impeller: Plastics (Flammability: UL94V-1)
- Expected Life Refer to specifications (L10:Survival rate:90% at 60°C ,
rated voltage, and continuously run in a free air state)
- Lead Wire Inlet ⊕ red ⊖ black (Sensor) yellow (Control) brown
Outlet ⊕ orange ⊖ gray (Sensor) purple (Control) white
- Storage Temperature -30°C to +70°C (Non-condensing)

38×38×48mm (Mass : 80g) **9CRA type**

Specifications

The following nos. **have PWM controls and pulse sensors.**

Model No.	Rated Voltage [V]	Operating Voltage Range [V]	PWM duty cycle* [%]	Rated Current [A]	Rated Input [W]	Rated Speed [min ⁻¹] Inlet Outlet	Max. Airflow [m ³ /min] [CFM]	Max. Static Pressure [Pa] [inchH ₂ O]	SPL [dB(A)]	Operating Temperature [°C]	Expected Life [h]
9CRA0312P4K03	12	10.8 to 13.2	100	1.5	18.0	17,600 14,520	0.77 27.2	700.0 2.81	64	-20 to +70	40,000/60°C
			0	0.2	2.4	5,280 4,200	0.22 7.8	54.9 0.22	33		
9CRA0312P4J03			100	1.1	13.2	16,000 13,200	0.7 24.7	560.0 2.25	62		
			0	0.18	2.2	4,800 3,960	0.21 7.4	50.4 0.20	31		

*PWM Frequency : 25kHz

Other sensor specifications are available as options. Please refer to the index (p. 501).

Dimensions (unit: mm)

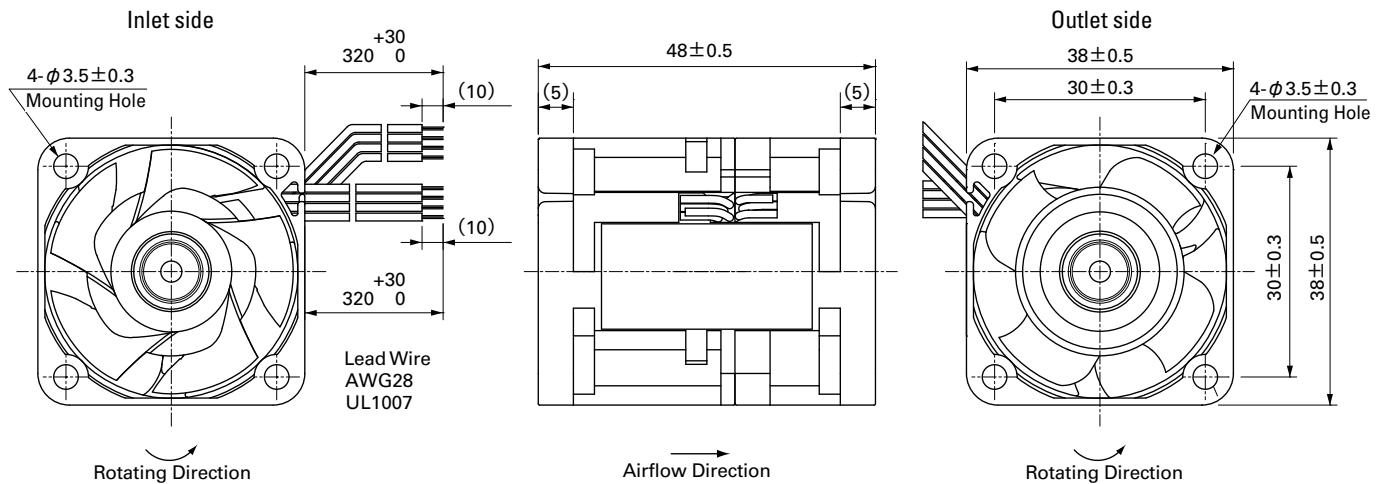

Reference Dimensions of Mounting Holes and Vent Opening (unit: mm)

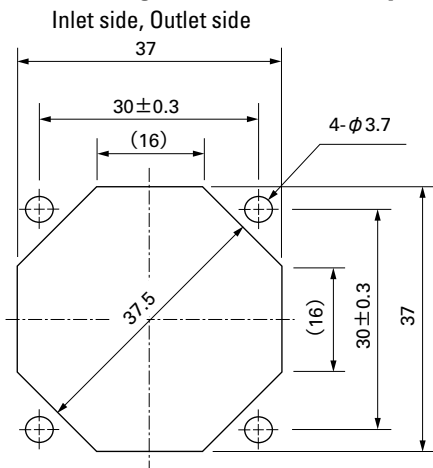

Options (unit: mm)

Finger Guards
Model : 109-1065 Surface treatment : Nickel-chrome plating (silver) Color

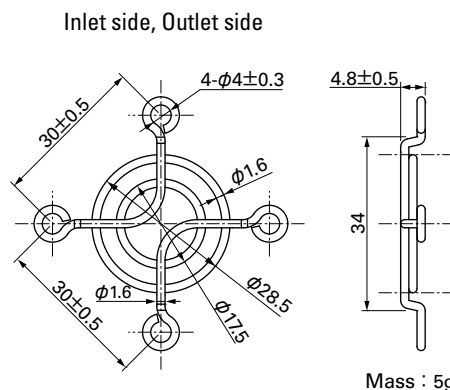

Airflow - Static Pressure Characteristics

PWM Duty Cycle

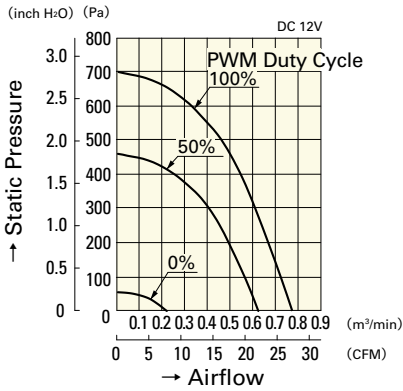

9CRA0312P4K03

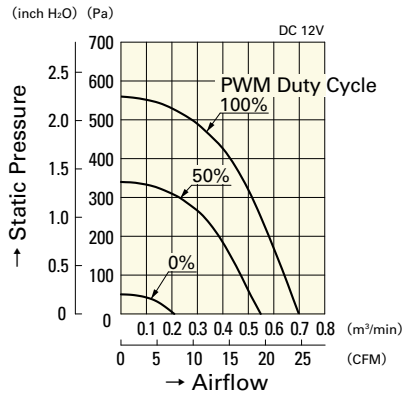

9CRA0312P4J03

Operating Voltage Range

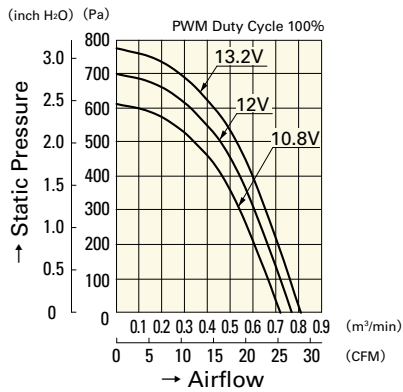

9CRA0312P4K03

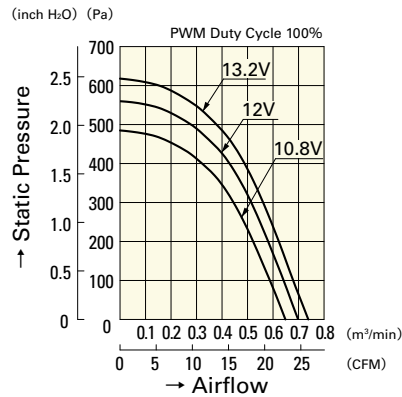

9CRA0312P4J03

PWM Duty - Speed Characteristics Example

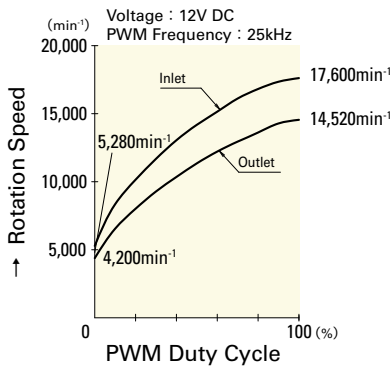

9CRA0312P4K03

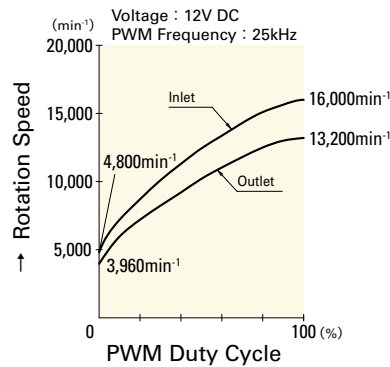

9CRA0312P4J03

Mouser Electronics

Authorized Distributor

Click to View Pricing, Inventory, Delivery & Lifecycle Information:

[Sanyo Denki:](#)

[9CRA0312P4K03](#) [9CRA0312P4J03](#) [9CRA0312J401](#) [9CRA0312K401](#) [9CRA0312J402](#) [9CRA0312K402](#)