

NTJD4401N, NVJD4401N

Small Signal MOSFET 20 V, Dual N-Channel, SC-88 ESD Protection

Features

- Small Footprint (2 x 2 mm)
- Low Gate Charge N-Channel Device
- ESD Protected Gate
- Same Package as SC-70 (6 Leads)
- AEC-Q101 Qualified and PPAP Capable – NVJD4401N
- These Devices are Pb-Free and are RoHS Compliant

Applications

- Load Power Switching
- Li-Ion Battery Supplied Devices
- Cell Phones, Media Players, Digital Cameras, PDAs
- DC-DC Conversion

MAXIMUM RATINGS (T_J = 25°C unless otherwise stated)

Parameter		Symbol	Value	Unit	
Drain-to-Source Voltage		V _{DSS}	20	V	
Gate-to-Source Voltage		V _{GS}	±12	V	
Continuous Drain Current (Based on R _{θJA})	Steady State	T _A = 25°C	I _D	0.63	A
		T _A = 85°C		0.46	
Power Dissipation (Based on R _{θJA})	Steady State	T _A = 25°C	P _D	0.27	W
		T _A = 85°C		0.14	
Continuous Drain Current (Based on R _{θJL})	Steady State	T _A = 25°C	I _D	0.91	A
		T _A = 85°C		0.65	
Power Dissipation (Based on R _{θJL})	Steady State	T _A = 25°C	P _D	0.55	W
		T _A = 85°C		0.29	
Pulsed Drain Current		t ≤ 10 μs	I _{DM}	±1.2	A
Operating Junction and Storage Temperature		T _J , T _{STG}	-55 to 150		°C
Continuous Source Current (Body Diode)		I _S	0.63		A
Lead Temperature for Soldering Purposes (1/8" from case for 10 s)		T _L	260		°C

THERMAL RESISTANCE RATINGS (Note 1)

Parameter	Symbol	Typ	Max	Units
Junction-to-Ambient – Steady State	R _{θJA}	400	458	°C/W
Junction-to-Lead (Drain) – Steady State	R _{θJL}	194	252	

Stresses exceeding those listed in the Maximum Ratings table may damage the device. If any of these limits are exceeded, device functionality should not be assumed, damage may occur and reliability may be affected.

1. Surface mounted on FR4 board using 1 oz Cu area = 0.9523 in sq.



ON Semiconductor®

www.onsemi.com

V _{(BR)DSS}	R _{DS(on)} Typ	I _D Max
20 V	0.29 Ω @ 4.5 V	0.63 A
	0.36 Ω @ 2.5 V	

SC-88 (SOT-363)

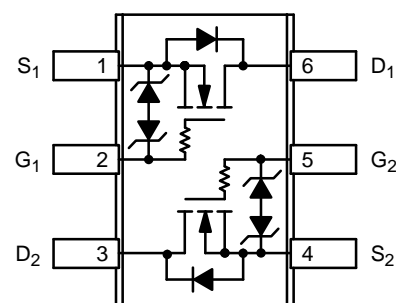

Top View

MARKING DIAGRAM & PIN ASSIGNMENT

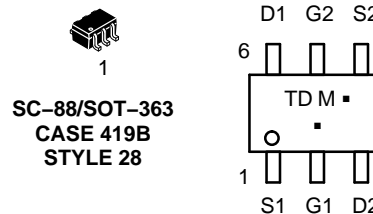

SC-88/SOT-363
CASE 419B
STYLE 28

TD = Device Code
M = Date Code
▪ = Pb-Free Package

(Note: Microdot may be in either location)

ORDERING INFORMATION

See detailed ordering and shipping information in the package dimensions section on page 4 of this data sheet.

NTJD4401N, NVJD4401N

ELECTRICAL CHARACTERISTICS (T_J = 25°C unless otherwise stated)

Parameter	Symbol	Test Condition	Min	Typ	Max	Unit
-----------	--------	----------------	-----	-----	-----	------

OFF CHARACTERISTICS

Drain-to-Source Breakdown Voltage	V _{(BR)DSS}	V _{GS} = 0 V, I _D = 250 μA	20	27		V
Drain-to-Source Breakdown Voltage Temperature Coefficient	V _{(BR)DSS} /T _J			22		mV/°C
Zero Gate Voltage Drain Current	I _{DSS}	V _{GS} = 0 V, V _{DS} = 16 V			1.0	μA
Gate-to-Source Leakage Current	I _{GSS}	V _{DS} = 0 V, V _{GS} = ±12 V			10	μA

ON CHARACTERISTICS (Note 2)

Gate Threshold Voltage	V _{GS(TH)}	V _{GS} = V _{DS} , I _D = 250 μA	0.6	0.92	1.5	V
Gate Threshold Temperature Coefficient	V _{GS(TH)} /T _J			-2.1		mV/°C
Drain-to-Source On Resistance	R _{DS(on)}	V _{GS} = 4.5 V, I _D = 0.63 A		0.29	0.375	Ω
		V _{GS} = 2.5 V, I _D = 0.40 A		0.36	0.445	
Forward Transconductance	g _{FS}	V _{DS} = 4.0 V, I _D = 0.63 A		2.0		S

CHARGES AND CAPACITANCES

Input Capacitance	C _{ISS}	V _{GS} = 0 V, f = 1.0 MHz, V _{DS} = 20 V		33	46	pF
Output Capacitance	C _{OSS}			13	22	
Reverse Transfer Capacitance	C _{RSS}			2.8	5.0	
Total Gate Charge	Q _{G(TOT)}	V _{GS} = 4.5 V, V _{DS} = 10 V, I _D = 0.63 A		1.3	3.0	nC
Threshold Gate Charge	Q _{G(TH)}			0.1		
Gate-to-Source Charge	Q _{GS}			0.2		
Gate-to-Drain Charge	Q _{GD}			0.4		

SWITCHING CHARACTERISTICS (Note 3)

Turn-On Delay Time	t _{d(ON)}	V _{GS} = 4.5 V, V _{DD} = 10 V, I _D = 0.5 A, R _G = 20 Ω		0.083		μs
Rise Time	t _r			0.227		
Turn-Off Delay Time	t _{d(OFF)}			0.786		
Fall Time	t _f			0.506		

DRAIN-SOURCE DIODE CHARACTERISTICS

Forward Diode Voltage	V _{SD}	V _{GS} = 0 V, I _S = 0.23 A	T _J = 25°C		0.76	1.1	V
			T _J = 125°C		0.63		
Reverse Recovery Time	t _{RR}	V _{GS} = 0 V, dI _S /dt = 100 A/μs, I _S = 0.63 A		0.410			μs

2. Pulse Test: pulse width ≤ 300 μs, duty cycle ≤ 2%.
3. Switching characteristics are independent of operating junction temperatures.

NTJD4401N, NVJD4401N

TYPICAL PERFORMANCE CURVES ($T_J = 25^\circ\text{C}$ unless otherwise noted)

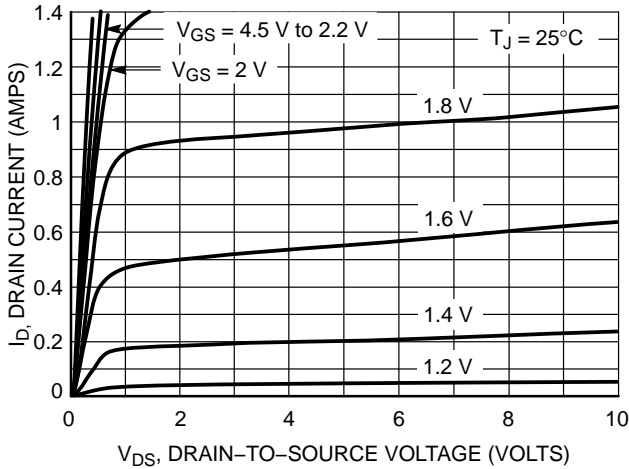

Figure 1. On-Region Characteristics

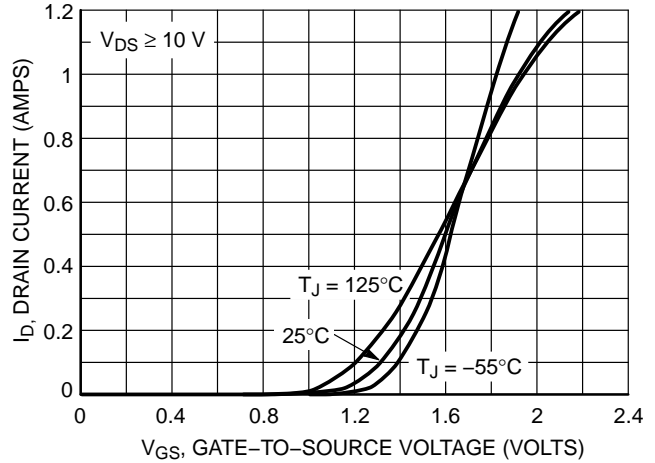

Figure 2. Transfer Characteristics

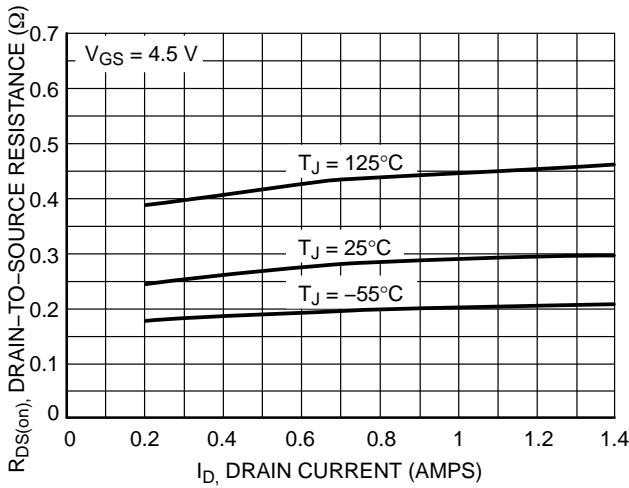

Figure 3. On-Resistance vs. Drain Current and Temperature

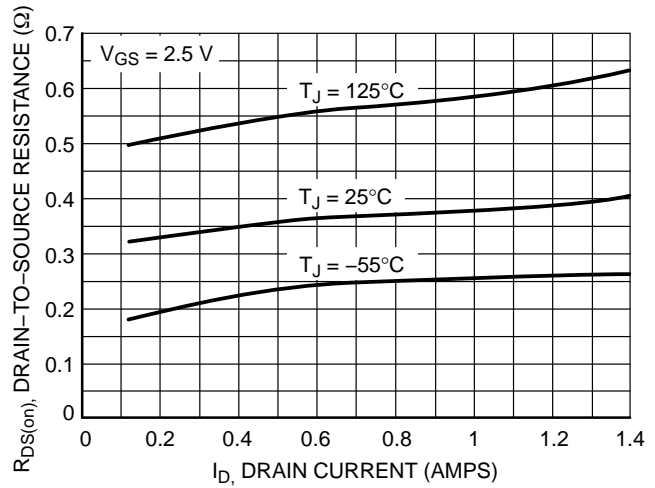

Figure 4. On-Resistance vs. Drain Current and Temperature

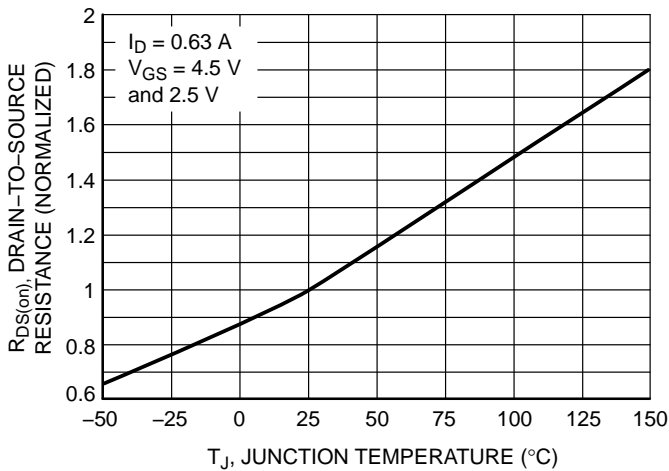

Figure 5. On-Resistance Variation with Temperature

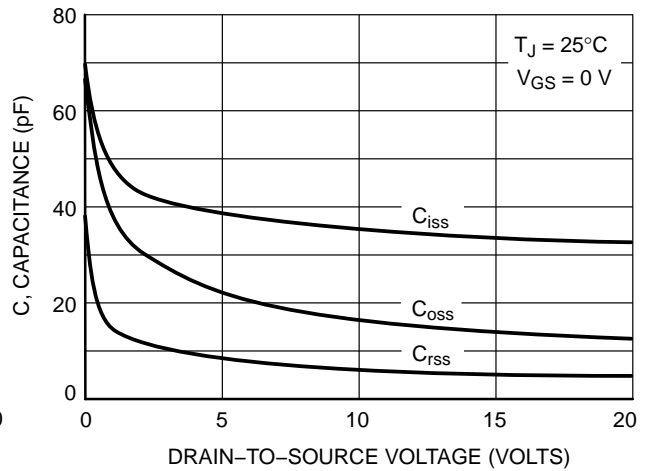

Figure 6. Capacitance Variation

NTJD4401N, NVJD4401N

TYPICAL PERFORMANCE CURVES ($T_J = 25^\circ\text{C}$ unless otherwise noted)

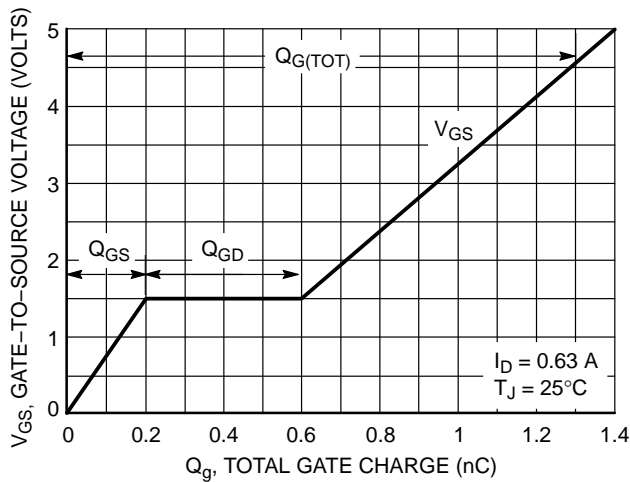

Figure 7. Gate-to-Source and Drain-to-Source Voltage vs. Total Charge

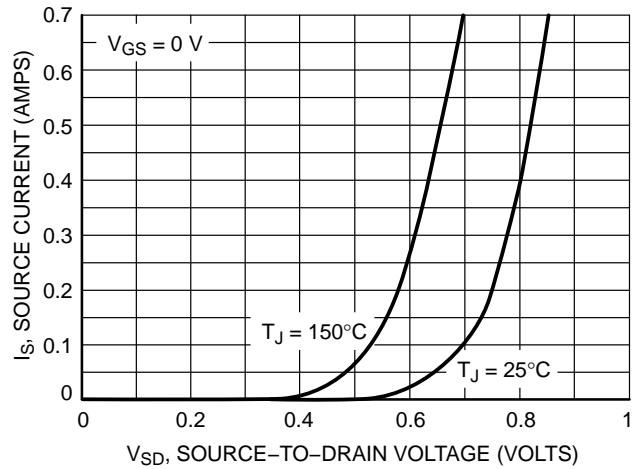

Figure 8. Diode Forward Voltage vs. Current

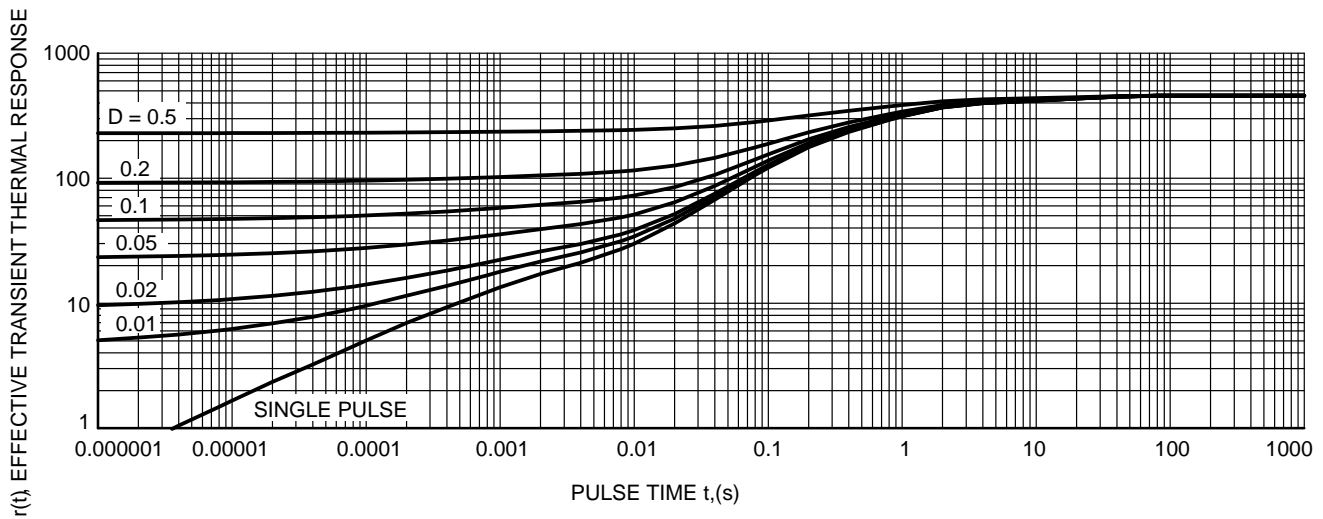

Figure 9. Thermal Response

ORDERING INFORMATION

Device	Package	Shipping [†]
NTJD4401NT1G	SC-88 (Pb-Free)	3000 / Tape & Reel
NVJD4401NT1G	SC-88 (Pb-Free)	3000 / Tape & Reel

[†]For information on tape and reel specifications, including part orientation and tape sizes, please refer to our Tape and Reel Packaging Specifications Brochure, BRD8011/D.

NTJD4401N, NVJD4401N

PACKAGE DIMENSIONS

SC-88/SC70-6/SOT-363
CASE 419B-02
ISSUE W

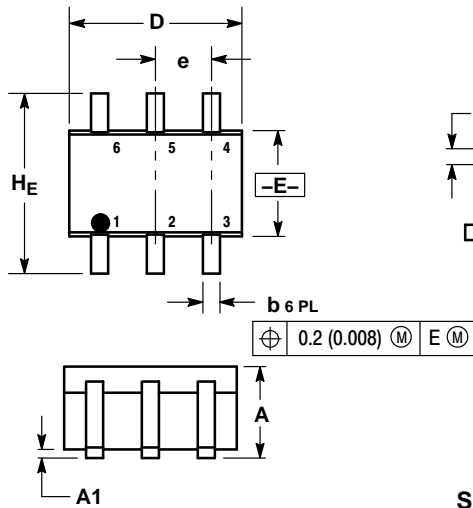

NOTES:

1. DIMENSIONING AND TOLERANCING PER ANSI Y14.5M, 1982.
2. CONTROLLING DIMENSION: INCH.
3. 419B-01 OBSOLETE, NEW STANDARD 419B-02.

DIM	MILLIMETERS			INCHES		
	MIN	NOM	MAX	MIN	NOM	MAX
A	0.80	0.95	1.10	0.031	0.037	0.043
A1	0.00	0.05	0.10	0.000	0.002	0.004
A3	0.20 REF			0.008 REF		
b	0.10	0.21	0.30	0.004	0.008	0.012
C	0.10	0.14	0.25	0.004	0.005	0.010
D	1.80	2.00	2.20	0.070	0.078	0.086
E	1.15	1.25	1.35	0.045	0.049	0.053
e	0.65 BSC			0.026 BSC		
L	0.10	0.20	0.30	0.004	0.008	0.012
HE	2.00	2.10	2.20	0.078	0.082	0.086

STYLE 26:

- PIN 1. SOURCE 1
- GATE 1
- DRAIN 2
- SOURCE 2
- GATE 2
- DRAIN 1

SOLDERING FOOTPRINT*

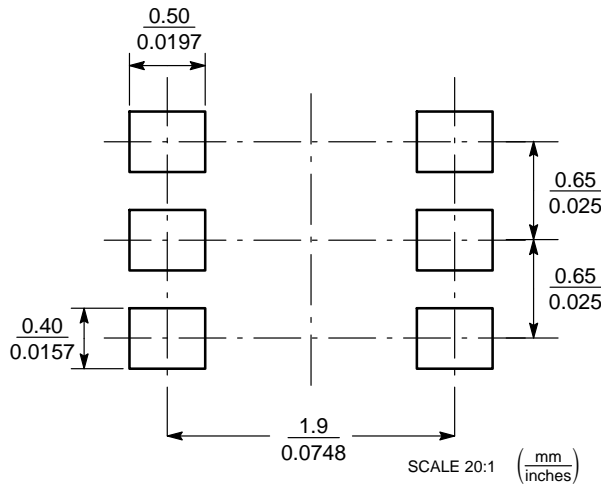

*For additional information on our Pb-Free strategy and soldering details, please download the ON Semiconductor Soldering and Mounting Techniques Reference Manual, SOLDERRM/D.

ON Semiconductor and the are registered trademarks of Semiconductor Components Industries, LLC (SCILLC) or its subsidiaries in the United States and/or other countries. SCILLC owns the rights to a number of patents, trademarks, copyrights, trade secrets, and other intellectual property. A listing of SCILLC's product/patent coverage may be accessed at www.onsemi.com/site/pdf/Patent-Marking.pdf. SCILLC reserves the right to make changes without further notice to any products herein. SCILLC makes no warranty, representation or guarantee regarding the suitability of its products for any particular purpose, nor does SCILLC assume any liability arising out of the application or use of any product or circuit, and specifically disclaims any and all liability, including without limitation special, consequential or incidental damages. "Typical" parameters which may be provided in SCILLC data sheets and/or specifications can and do vary in different applications and actual performance may vary over time. All operating parameters, including "Typicals" must be validated for each customer application by customer's technical experts. SCILLC does not convey any license under its patent rights nor the rights of others. SCILLC products are not designed, intended, or authorized for use as components in systems intended for surgical implant into the body, or other applications intended to support or sustain life, or for any other application in which the failure of the SCILLC product could create a situation where personal injury or death may occur. Should Buyer purchase or use SCILLC products for any such unintended or unauthorized application, Buyer shall indemnify and hold SCILLC and its officers, employees, subsidiaries, affiliates, and distributors harmless against all claims, costs, damages, and expenses, and reasonable attorney fees arising out of, directly or indirectly, any claim of personal injury or death associated with such unintended or unauthorized use, even if such claim alleges that SCILLC was negligent regarding the design or manufacture of the part. SCILLC is an Equal Opportunity/Affirmative Action Employer. This literature is subject to all applicable copyright laws and is not for resale in any manner.

PUBLICATION ORDERING INFORMATION

LITERATURE FULFILLMENT:

Literature Distribution Center for ON Semiconductor
P.O. Box 5163, Denver, Colorado 80217 USA
Phone: 303-675-2175 or 800-344-3860 Toll Free USA/Canada
Fax: 303-675-2176 or 800-344-3867 Toll Free USA/Canada
Email: orderlit@onsemi.com

N. American Technical Support: 800-282-9855 Toll Free
USA/Canada
Europe, Middle East and Africa Technical Support:
Phone: 421 33 790 2910
Japan Customer Focus Center
Phone: 81-3-5817-1050

ON Semiconductor Website: www.onsemi.com

Order Literature: <http://www.onsemi.com/orderlit>

For additional information, please contact your local Sales Representative

Mouser Electronics

Authorized Distributor

Click to View Pricing, Inventory, Delivery & Lifecycle Information:

[ON Semiconductor:](#)

[NTJD4401NT1G](#)