

# INTERCONNECTS

## SERIES 802 & 803 • .100" GRID (.030" DIA. PINS), STRAIGHT & RIGHT ANGLE HEADERS AND SOCKETS • DOUBLE ROW STRIPS

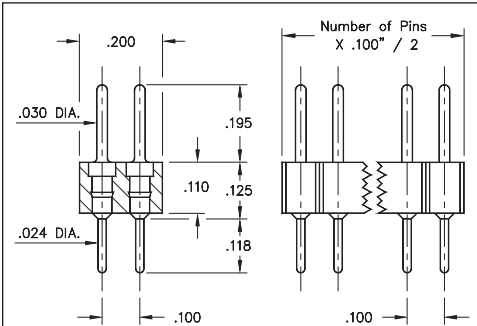

FIG. 1

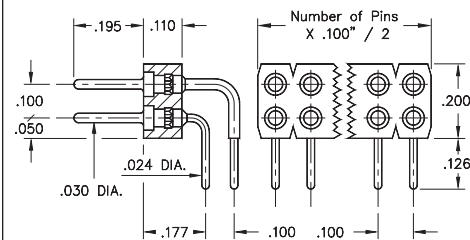

FIG. 2

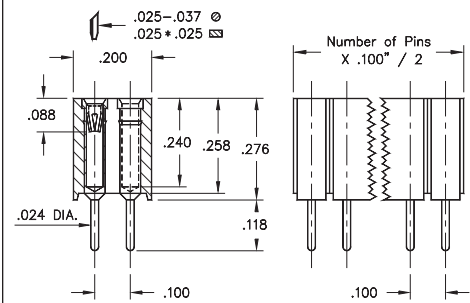

FIG. 3

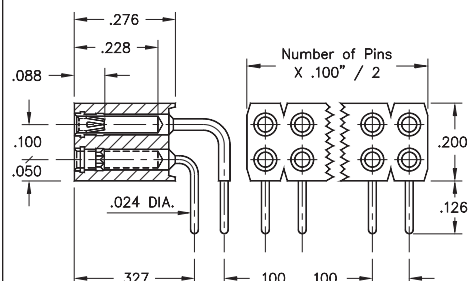
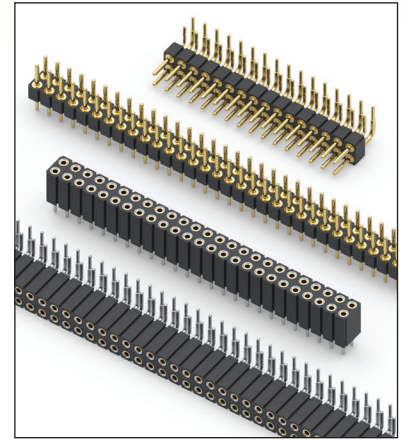

FIG. 4

- Pin interconnects available with straight MM #7007 or right angle MM #5005/5107 solder tails. See page 215 for details
- Sockets are available with straight MM #1304 or right angle MM #1305/1306 soldertails. See pages 177 and 179 for details
- MM #1304, #1305 and #1306 receptacles use Hi-Rel, 6-finger BeCu #47 contact rated at 4.5 amps. Receptacles accept .030" diameter and .025" square pins. See page 256 for details
- Insulators are high temperature thermoplastic, suitable for all soldering operations



### ORDERING INFORMATION





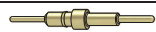

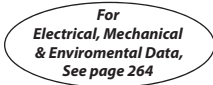





FIG. 1	Series 802...10-001	Straight Pin Header		
	802-XX-0	-10-001000	Specify number of pins 04-64	
FIG. 2	Series 802...20-001	Right Angle Pin Header		
	802-XX-0	-20-001000	Specify number of pins 02-64	
  				
SPECIFY PLATING CODE XX=		10 	90	40 
Pin Plating 		10 μ" Au	200 μ" Sn/Pb	200 μ" Sn

FIG. 3	Series 803...10-001	Straight Socket						
	803-XX-	-10-001000	Specify number of pins 004-100					
FIG. 4	Series 803...20-001	Right Angle Socket						
	803-XX-	-20-001000	Specify number of pins 002-100					
  								
SPECIFY PLATING CODE XX=			91	93	99	41 	43 	47 
Sleeve (Pin) 			200 μ" Sn/Pb	200 μ" Sn/Pb	200 μ" Sn/Pb	200 μ" Sn	200 μ" Sn	200 μ" Sn
Contact (Clip) 			10 μ" Au	30 μ" Au	100 μ" Sn/Pb	10 μ" Au	30 μ" Au	Au Flash



# Mouser Electronics

Authorized Distributor

Click to View Pricing, Inventory, Delivery & Lifecycle Information:

## Mill-Max:

[803-99-100-10-001000](#) [803-99-072-10-001000](#) [803-93-100-10-001000](#) [803-93-072-20-001000](#) [802-90-064-20-001000](#) [802-90-064-10-001000](#) [803-43-014-10-001000](#) [803-43-100-20-001000](#) [803-43-072-10-001000](#) [802-10-064-20-001000](#) [802-10-064-10-001000](#) [803-93-100-20-001000](#) [803-99-026-20-001000](#) [803-93-072-10-001000](#) [803-43-006-10-001000](#) [803-93-018-10-001000](#) [803-43-100-10-001000](#) [803-43-072-20-001000](#) [802-40-064-20-001000](#) [802-40-064-10-001000](#) [803-93-030-10-001000](#) [803-43-010-10-001000](#) [803-43-006-20-001000](#) [803-43-008-10-001000](#) [803-43-004-20-001000](#) [803-43-064-10-001000](#) [803-43-008-20-001000](#) [803-43-004-10-001000](#) [803-43-064-20-001000](#) [803-43-010-20-001000](#) [802-10-064-10-001100](#) [802-10-028-20-001100](#)