

### ●Features

- 1) Ultra low-ohmic resistance range.
- 2) Wide terminal configuration for high joint reliability.
- 3) Improved current detection accuracy by trimming-less structure.
- 4) ROHM resistors have obtained ISO9001 / ISO / TS16949 certification.

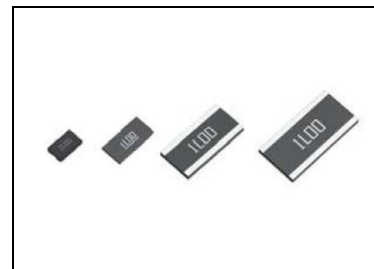

### ●Products List

Part No.	Size		Rated power (70°C) (W)	Temperature coefficient (ppm / °C)	Resistance tolerance (%)	Resistance range (mΩ)	Operating temperature range (°C)
	(mm)	(inch)					
PML10	2012	0805	0.66	±200	G (±2%)	1.0,1.5,2.0,2.5	-55 ~ +155
					J (±5%)		
PML18	3216	1206	1	±150	G (±2%)	0.5,1.0,1.5,2.0,2.5	-55 ~ +155
					J (±5%)		
PML50	5025	2010	2	±150	J (±5%)	0.5	-55 ~ +155
				±100		2.2	
				☆±200		☆(1.0,1.5,2.0)	
PML100	6432	2512	2 (3W at 25°C)	±150	J (±5%)	0.5	-55 ~ +155
			2	±100		1.0,1.5,2.0,2.2	

☆:Under development

\*Design and specifications are subject to change without notice.

Carefully check the specification sheet supplied with the product before using or ordering it.

### ●Part number description

P M L	1 0	E Z P	J	V	1 L 0																																													
<b>Part No.</b> PML (Ultra-low ohmic chip resistors for current detection / wide terminal type>)	<b>Size (mm[inch])</b> 10 (2012 [0805]) 18 (3216 [1206]) 50 (5025 [2010]) 100 (6432 [2512])	<b>Packaging specifications code</b>	<b>Resistance tolerance</b> G (±2%) J (±5%)	<b>Special part code</b>	<b>Nominal resistance</b>																																													
		<table border="1"> <thead> <tr> <th>Part No.</th> <th>Code</th> <th>Packaging specifications</th> <th>Quantity / Reel</th> </tr> </thead> <tbody> <tr> <td>PML10</td> <td>EZP</td> <td>Paper tape (4mm pitch)</td> <td>5,000</td> </tr> <tr> <td>PML18</td> <td>EZP</td> <td>Paper tape (4mm pitch)</td> <td>5,000</td> </tr> <tr> <td>PML50</td> <td>HZP</td> <td>Embossed tape (4mm pitch)</td> <td>2,000</td> </tr> <tr> <td>PML100</td> <td>HZP</td> <td>Embossed tape (4mm pitch)</td> <td>2,000</td> </tr> </tbody> </table>	Part No.	Code	Packaging specifications	Quantity / Reel	PML10	EZP	Paper tape (4mm pitch)	5,000	PML18	EZP	Paper tape (4mm pitch)	5,000	PML50	HZP	Embossed tape (4mm pitch)	2,000	PML100	HZP	Embossed tape (4mm pitch)	2,000		<table border="1"> <thead> <tr> <th colspan="3">Resistance code, 3 or 4 digits.</th> </tr> <tr> <th rowspan="2">Resistance value(Ω)</th> <th colspan="2">Resistance tolerance</th> </tr> <tr> <th>J</th> <th>G</th> </tr> </thead> <tbody> <tr> <td>0.5mΩ</td> <td>0L5</td> <td>0L50</td> </tr> <tr> <td>1mΩ</td> <td>1L0</td> <td>1L00</td> </tr> <tr> <td>1.5mΩ</td> <td>1L5</td> <td>1L50</td> </tr> <tr> <td>2mΩ</td> <td>2L0</td> <td>2L00</td> </tr> <tr> <td>2.2mΩ</td> <td>2L2</td> <td>-</td> </tr> <tr> <td>2.5mΩ</td> <td>2L5</td> <td>2L50</td> </tr> </tbody> </table>	Resistance code, 3 or 4 digits.			Resistance value(Ω)	Resistance tolerance		J	G	0.5mΩ	0L5	0L50	1mΩ	1L0	1L00	1.5mΩ	1L5	1L50	2mΩ	2L0	2L00	2.2mΩ	2L2	-	2.5mΩ	2L5	2L50
Part No.	Code	Packaging specifications	Quantity / Reel																																															
PML10	EZP	Paper tape (4mm pitch)	5,000																																															
PML18	EZP	Paper tape (4mm pitch)	5,000																																															
PML50	HZP	Embossed tape (4mm pitch)	2,000																																															
PML100	HZP	Embossed tape (4mm pitch)	2,000																																															
Resistance code, 3 or 4 digits.																																																		
Resistance value(Ω)	Resistance tolerance																																																	
	J	G																																																
0.5mΩ	0L5	0L50																																																
1mΩ	1L0	1L00																																																
1.5mΩ	1L5	1L50																																																
2mΩ	2L0	2L00																																																
2.2mΩ	2L2	-																																																
2.5mΩ	2L5	2L50																																																

●Chip resistor dimensions and markings

■ PML 10 / 18

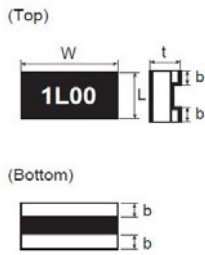

■ PML 50 / 100

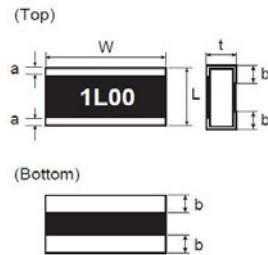

<Marking method>

There are four digits used for the calculation number "L" is used for the decimal point of m .

Ex.) 2m Ω = 2L00

10m Ω = 10L0

(Unit:mm)

Part No.	(mm)	(inch)	L	W	t	a	b	Marking existence
PML10	2012	0805	1.20±0.15	2.0±0.15	0.42 ~ 0.28*±0.15	-	0.45 ~ 0.35*±0.25	Yes
PML18	3216	1206	1.60±0.15	3.20±0.15	0.42 ~ 0.28*±0.15	-	0.55 ~ 0.35*±0.20	Yes
PML50	5025	2010	2.60±0.20	5.00±0.20	0.50 ~ 0.36*±0.15	0.40±0.20	0.75 ~ 0.70*±0.20	Yes
PML100	6432	2512	3.20±0.25	6.40±0.25	0.50 ~ 0.36*±0.15	0.45±0.25	0.90 ~ 0.70*±0.25	Yes

\* : Each value range varies with the resistance. Please contact a ROHM sales representative for further details.

●Land pattern example

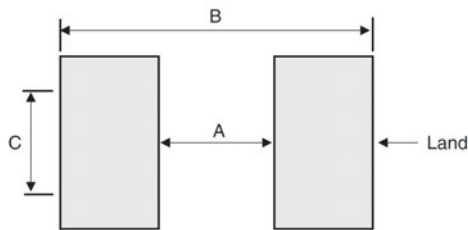

(Unit:mm)

Part No.	Dimensions	A	B	C	D
PML10		0.14	1.6	2.0	0.73
PML18		0.325	2.675	3.2	1.175
PML50		0.8	3.35	5.0	1.275
PML100		0.8	4.2	6.4	1.7

●Derating curve

When the ambient temperature exceeds 70°C, power dissipation must be adjusted according to the derating curves below.

■PML10/18/50/100

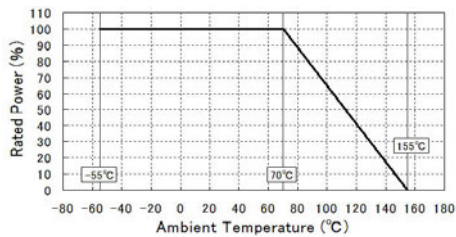

●Characteristics (PML10/18/50/100)

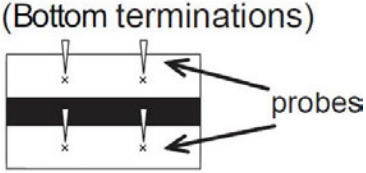
Test items	Guaranteed > Resistor type	Test conditions
Resistance	See P.1	20°C Measuring method : Measure Bottom termination by 4 probes.  
Variation of resistance with temperature	See P.1	Measurement: +25/-55, +25/+125°C
Overload	±(2.0%+0.0001Ω)	Rated power×2.5, 2s
Solderability	A new uniform coating of minimum of 95% of the surface being immersed and no soldering damage.	Rosin-ethanol solution(25% weight) Soldering condition: 245±5°C Duration of immersion: 2.0±0.5s
Resistance to soldering heat	±(1.0%+0.0001Ω) No remarkable abnormality on the appearance.	Soldering condition: 260±5°C Duration of immersion: 10±1s
Rapid change of temperature	±(1.0%+0.0001Ω)	Test temp: -55°C~+125°C 5cycle
Damp heat, steady state	±(3.0%+0.0001Ω)	40°C, 93%(Relative humidity) Test time: 1,000h
Endurance at 70°C	±(3.0%+0.0001Ω)	70°C, Rated power 1.5h:ON—0.5h:OFF Test time: 1,000h
Endurance	±(3.0%+0.0001Ω)	155°C Test time: 1,000h
Resistance to solvent	±(0.5%+0.0001Ω)	23±5°C Immersion cleaning, 5±0.5min Solvent: 2-propanol
Bend strength of the end face plating	Without open.	-

Compliance Standard(s) : IEC60115-8  
JISC 5201-8

●Tape dimensions

■Paper tape

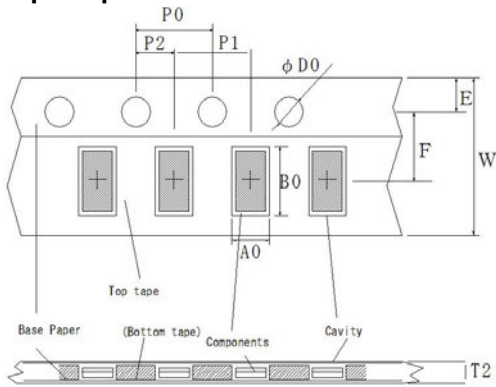

(Unit : mm)

Part No.	W	F	E	A0	B0
<b>PML10</b>	8.0±0.3	3.5±0.05	1.75±0.1	1.65 <sup>+0.2</sup> <sub>-0.1</sub>	2.4 <sup>+0.2</sup> <sub>-0.1</sub>
<b>PML18</b>	8.0±0.3	3.5±0.05	1.75±0.1	1.95 <sup>+0.1</sup> <sub>-0.05</sub>	3.5 <sup>+0.15</sup> <sub>-0.05</sub>

Part No.	D0	F0	P1	P2	T2
<b>PML10</b>	Φ1.5 <sup>+0.1</sup> <sub>0</sub>	4.0±0.1	4.0±0.1	2.0±0.05	MAX1.1
<b>PML18</b>	Φ1.5 <sup>+0.1</sup> <sub>0</sub>	4.0±0.1	4.0±0.1	2.0±0.05	MAX1.1

■Embossed tape

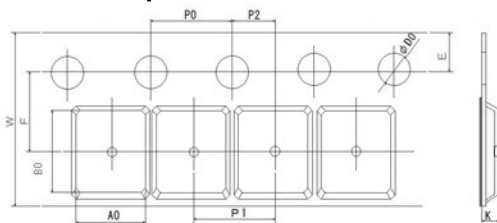

(Unit : mm)

Part No.	W	F	E	A0	B0
<b>PML50</b>	12.0±0.3	5.5±0.05	1.75±0.1	2.9±0.2	5.3±0.2
<b>PML100</b>	12.0±0.3	5.5±0.05	1.75±0.1	3.5±0.2	6.7±0.2

Part No.	D0	F0	P1	P2	K
<b>PML50</b>	Φ1.5 <sup>+0.1</sup> <sub>0</sub>	4.0±0.1	4.0±0.1	2.0±0.05	MAX1.1
<b>PML100</b>	Φ1.5 <sup>+0.1</sup> <sub>0</sub>	4.0±0.1	4.0±0.1	2.0±0.05	MAX1.1

●Reel dimensions

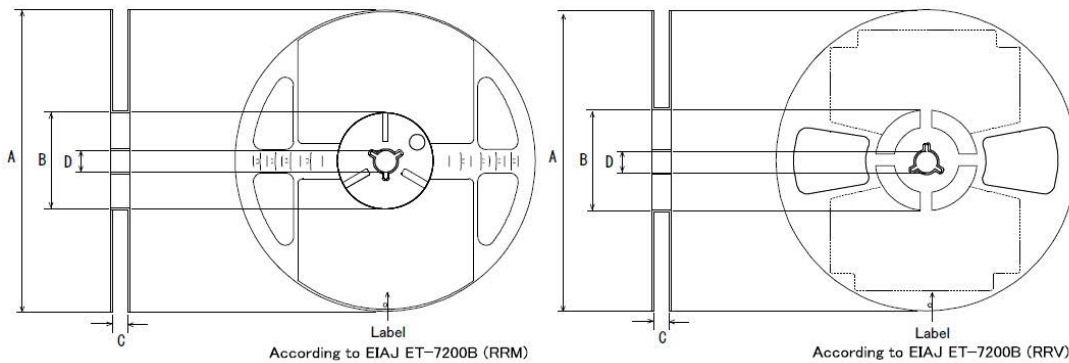

(Unit : mm)

Part No.	A	B	C	D
<b>PML10</b>	Φ180 <sup>0</sup> <sub>-1.5</sub>	Φ60 <sup>+1.0</sup> <sub>0</sub>	9 <sup>+1.0</sup> <sub>0</sub>	Φ13±0.2
<b>PML18</b>			13 <sup>+1.0</sup> <sub>0</sub>	
<b>PML50</b>				
<b>PML100</b>				

# Notice

## Precaution on using ROHM Products

- Our Products are designed and manufactured for application in ordinary electronic equipment (such as AV equipment, OA equipment, telecommunication equipment, home electronic appliances, amusement equipment, etc.). If you intend to use our Products in devices requiring extremely high reliability (such as medical equipment <sup>(Note 1)</sup>, transport equipment, traffic equipment, aircraft/spacecraft, nuclear power controllers, fuel controllers, car equipment including car accessories, safety devices, etc.) and whose malfunction or failure may cause loss of human life, bodily injury or serious damage to property ("Specific Applications"), please consult with the ROHM sales representative in advance. Unless otherwise agreed in writing by ROHM in advance, ROHM shall not be in any way responsible or liable for any damages, expenses or losses incurred by you or third parties arising from the use of any ROHM's Products for Specific Applications.

(Note1) Medical Equipment Classification of the Specific Applications

JAPAN	USA	EU	CHINA
CLASS III	CLASS III	CLASS II b	CLASS III
CLASS IV		CLASS III	

- ROHM designs and manufactures its Products subject to strict quality control system. However, semiconductor products can fail or malfunction at a certain rate. Please be sure to implement, at your own responsibilities, adequate safety measures including but not limited to fail-safe design against the physical injury, damage to any property, which a failure or malfunction of our Products may cause. The following are examples of safety measures:
  - Installation of protection circuits or other protective devices to improve system safety
  - Installation of redundant circuits to reduce the impact of single or multiple circuit failure
- Our Products are designed and manufactured for use under standard conditions and not under any special or extraordinary environments or conditions, as exemplified below. Accordingly, ROHM shall not be in any way responsible or liable for any damages, expenses or losses arising from the use of any ROHM's Products under any special or extraordinary environments or conditions. If you intend to use our Products under any special or extraordinary environments or conditions (as exemplified below), your independent verification and confirmation of product performance, reliability, etc. prior to use, must be necessary:
  - Use of our Products in any types of liquid, including water, oils, chemicals, and organic solvents
  - Use of our Products outdoors or in places where the Products are exposed to direct sunlight or dust
  - Use of our Products in places where the Products are exposed to sea wind or corrosive gases, including Cl<sub>2</sub>, H<sub>2</sub>S, NH<sub>3</sub>, SO<sub>2</sub>, and NO<sub>2</sub>
  - Use of our Products in places where the Products are exposed to static electricity or electromagnetic waves
  - Use of our Products in proximity to heat-producing components, plastic cords, or other flammable items
  - Sealing or coating our Products with resin or other coating materials
  - Use of our Products without cleaning residue of flux (Exclude cases where no-clean type fluxes is used. However, recommend sufficiently about the residue.) ; or Washing our Products by using water or water-soluble cleaning agents for cleaning residue after soldering
  - Use of the Products in places subject to dew condensation
- The Products are not subject to radiation-proof design.
- Please verify and confirm characteristics of the final or mounted products in using the Products.
- In particular, if a transient load (a large amount of load applied in a short period of time, such as pulse, is applied, confirmation of performance characteristics after on-board mounting is strongly recommended. Avoid applying power exceeding normal rated power; exceeding the power rating under steady-state loading condition may negatively affect product performance and reliability.
- De-rate Power Dissipation depending on ambient temperature. When used in sealed area, confirm that it is the use in the range that does not exceed the maximum junction temperature.
- Confirm that operation temperature is within the specified range described in the product specification.
- ROHM shall not be in any way responsible or liable for failure induced under deviant condition from what is defined in this document.

## Precaution for Mounting / Circuit board design

- When a highly active halogenous (chlorine, bromine, etc.) flux is used, the residue of flux may negatively affect product performance and reliability.
- In principle, the reflow soldering method must be used on a surface-mount products, the flow soldering method must be used on a through hole mount products. If the flow soldering method is preferred on a surface-mount products, please consult with the ROHM representative in advance.

For details, please refer to ROHM Mounting specification

### Precautions Regarding Application Examples and External Circuits

1. If change is made to the constant of an external circuit, please allow a sufficient margin considering variations of the characteristics of the Products and external components, including transient characteristics, as well as static characteristics.
2. You agree that application notes, reference designs, and associated data and information contained in this document are presented only as guidance for Products use. Therefore, in case you use such information, you are solely responsible for it and you must exercise your own independent verification and judgment in the use of such information contained in this document. ROHM shall not be in any way responsible or liable for any damages, expenses or losses incurred by you or third parties arising from the use of such information.

### Precaution for Electrostatic

This Product is electrostatic sensitive product, which may be damaged due to electrostatic discharge. Please take proper caution in your manufacturing process and storage so that voltage exceeding the Products maximum rating will not be applied to Products. Please take special care under dry condition (e.g. Grounding of human body / equipment / solder iron, isolation from charged objects, setting of Ionizer, friction prevention and temperature / humidity control).

### Precaution for Storage / Transportation

1. Product performance and soldered connections may deteriorate if the Products are stored in the places where:
  - [a] the Products are exposed to sea winds or corrosive gases, including Cl<sub>2</sub>, H<sub>2</sub>S, NH<sub>3</sub>, SO<sub>2</sub>, and NO<sub>2</sub>
  - [b] the temperature or humidity exceeds those recommended by ROHM
  - [c] the Products are exposed to direct sunshine or condensation
  - [d] the Products are exposed to high Electrostatic
2. Even under ROHM recommended storage condition, solderability of products out of recommended storage time period may be degraded. It is strongly recommended to confirm solderability before using Products of which storage time is exceeding the recommended storage time period.
3. Store / transport cartons in the correct direction, which is indicated on a carton with a symbol. Otherwise bent leads may occur due to excessive stress applied when dropping of a carton.
4. Use Products within the specified time after opening a humidity barrier bag. Baking is required before using Products of which storage time is exceeding the recommended storage time period.

### Precaution for Product Label

A two-dimensional barcode printed on ROHM Products label is for ROHM's internal use only.

### Precaution for Disposition

When disposing Products please dispose them properly using an authorized industry waste company.

### Precaution for Foreign Exchange and Foreign Trade act

Since concerned goods might be fallen under listed items of export control prescribed by Foreign exchange and Foreign trade act, please consult with ROHM in case of export.

### Precaution Regarding Intellectual Property Rights

1. All information and data including but not limited to application example contained in this document is for reference only. ROHM does not warrant that foregoing information or data will not infringe any intellectual property rights or any other rights of any third party regarding such information or data.
2. ROHM shall not have any obligations where the claims, actions or demands arising from the combination of the Products with other articles such as components, circuits, systems or external equipment (including software).
3. No license, expressly or implied, is granted hereby under any intellectual property rights or other rights of ROHM or any third parties with respect to the Products or the information contained in this document. Provided, however, that ROHM will not assert its intellectual property rights or other rights against you or your customers to the extent necessary to manufacture or sell products containing the Products, subject to the terms and conditions herein.

### Other Precaution

1. This document may not be reprinted or reproduced, in whole or in part, without prior written consent of ROHM.
2. The Products may not be disassembled, converted, modified, reproduced or otherwise changed without prior written consent of ROHM.
3. In no event shall you use in any way whatsoever the Products and the related technical information contained in the Products or this document for any military purposes, including but not limited to, the development of mass-destruction weapons.
4. The proper names of companies or products described in this document are trademarks or registered trademarks of ROHM, its affiliated companies or third parties.

**General Precaution**

1. Before you use our Products, you are requested to carefully read this document and fully understand its contents. ROHM shall not be in any way responsible or liable for failure, malfunction or accident arising from the use of any ROHM's Products against warning, caution or note contained in this document.
2. All information contained in this document is current as of the issuing date and subject to change without any prior notice. Before purchasing or using ROHM's Products, please confirm the latest information with a ROHM sales representative.
3. The information contained in this document is provided on an "as is" basis and ROHM does not warrant that all information contained in this document is accurate and/or error-free. ROHM shall not be in any way responsible or liable for any damages, expenses or losses incurred by you or third parties resulting from inaccuracy or errors of or concerning such information.

# Mouser Electronics

Authorized Distributor

Click to View Pricing, Inventory, Delivery & Lifecycle Information:

## ROHM Semiconductor:

[PML100HZPJV2L0](#) [PML100HZPJV2L2](#) [PML18EZPGV1L00](#) [PML100HZPJV1L0](#) [PML18EZPGV2L50](#)  
[PML18EZPGV2L00](#) [PML18EZPGV1L50](#) [PML100HZPJV1L5](#) [PML10EZPGV1L00](#) [PML100HZPJV0L5](#)  
[PML18EZPGV0L50](#)