

IDMD-24-S-12.00-G

(2,54mm) .100"

IDSS, IDSD, IDMS, IDMD SERIES

# SLIM BODY FLAT RIBBON IDC CABLES

## SPECIFICATIONS

### IDSS, IDSD

For complete specifications see [www.samtec.com?IDSS](http://www.samtec.com?IDSS) or [www.samtec.com?IDSD](http://www.samtec.com?IDSD)

#### Insulator Material:

Black Glass Filled Polyester



#### Plating:

Au over 50µ" (1,27µm) Ni or Sn over 100µ" (2,54µm) Cu or 50µ" (1,27µm) Ni

#### Wire:

28 AWG 7/36 stranded Tinned Copper

#### Temperature Range:

-20°C to +105°C (Rainbow Cable)  
-40°C to +105°C (Gray Cable)

#### Contact:

BeCu

#### Current Rating:

1A

#### Contact Resistance:

15 mΩ max delta from initial

#### Lead Size Range:

(0,56mm) .022" SQ to (0,71mm) .028" SQ

#### Lead Insertion Depth:

(5,59mm) .220" to (6,22mm) .245"

#### Insertion Force:

(Single contact only)

4oz avg.

((0,64mm) .025" SQ probe)

#### Withdrawal Force:

(Single contact only)

3oz avg.

((0,64mm) .025" SQ probe)

RoHS Compliant: Yes

#### Mates with:

TSW, MTSW, TSM, EJH, PHT

#### IDSD Mates with:

TST, HTST, ZST

TYPE STRIP

ROW OPTION

NO. PINS PER ROW

END ASSEMBLY

IDM

= Standard Tail Male Plug

IDS

= Socket

S

= Single

D

= Double (Color coded cable N/A for 31 thru 36 pins/row. See -G option.)

-S = Single End

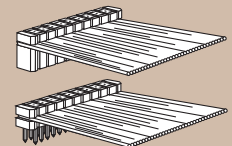

Socket or Male Plug on one end

-D = Double End

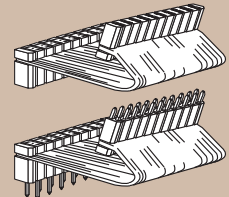

Socket or Male Plug on each end

-T = Transfer End

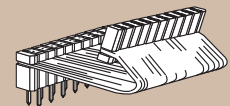

Male Plug on one end with socket on other. Begin part number with IDM.

## -02 thru -32

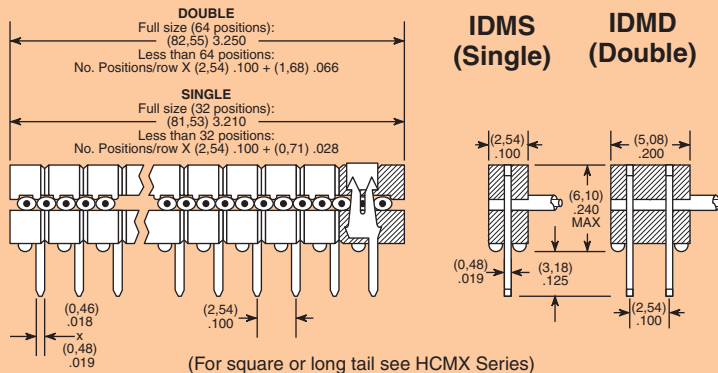

## -02 thru -36

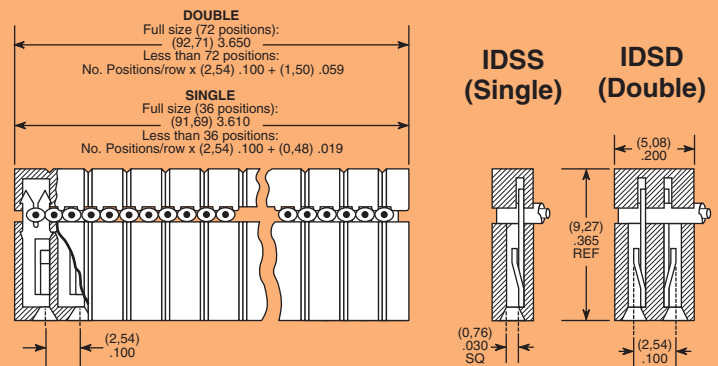

Due to technical progress, all designs, specifications and components are subject to change without notice.

WWW.SAMTEC.COM

## ALSO AVAILABLE

### Molded-To-Position IDC Assemblies

- Low Profile
  - Skinny side locks
  - Dual beam contacts
  - Single and double row
  - (6,35mm) .025" square and (5,84mm) .230" length tail available
- Call Samtec for HCXX Series.

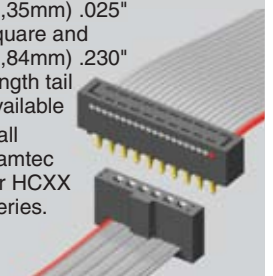

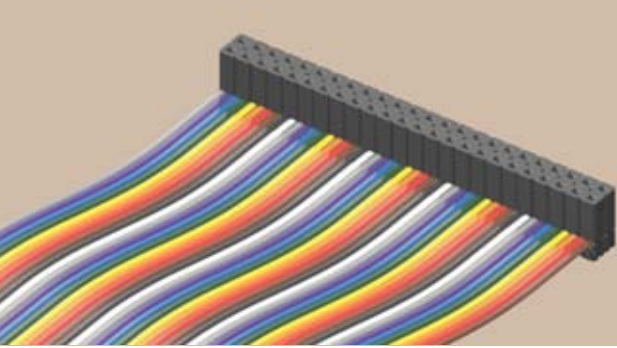

IDSD-24-S-05.00

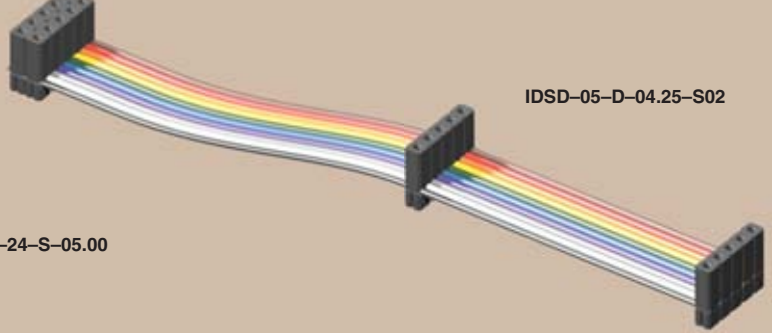

IDSD-05-D-04.25-S02

**ASSEMBLED LENGTH**

— “XX.XX”  
= Assembled Length

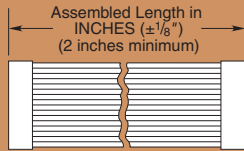

**OPTION**

**POLARIZING KEY**

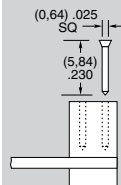

Optional polarizing key for use with IDSS & IDSD Series. Also polarizes SSW, SSQ, ESW & ESQ Series. Black High Temperature Thermoplastic

Order: Part Number PK-01-06  
(Available in wheels of six each)

**EJECTOR HEADERS & LOCKING CLIPS**



- Ejector headers
- Locking clips

IDSS or IDSD STRIP ASSEMBLY

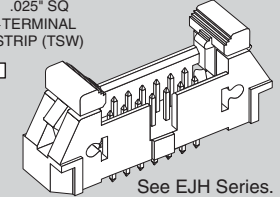
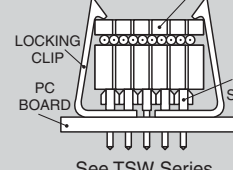

—T = Tin Plating (Both ends)

—C = Tin IDM = 10 $\mu$  (0,25 $\mu$ m) Gold IDS (-T End Assembly Required)

—A = 10 $\mu$  (0,25 $\mu$ m) Gold IDM = Tin IDS (-T End Assembly Required)

Standard plating is selective gold over BeCu contact for IDS; Selective gold over phosphor bronze for IDM.

1

—ST “X”

= Stripped & Tinned

Specify Suffix from table. All dimensions are  $\pm 1/16"$ . Not available in 28 positions and higher.

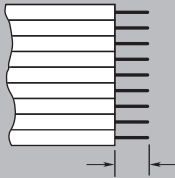

4

—S “XX”

= Daisy Chain Single

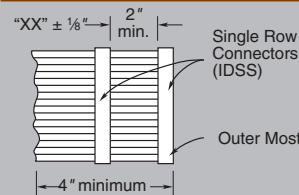

When mating double row connector with two single row connectors, the outer most single will be connected to Conductor #1 and the inside single to Conductor #2.

7

—R

= Reversed

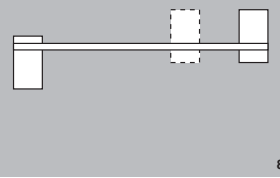

8

—P “XX”

= Polarized

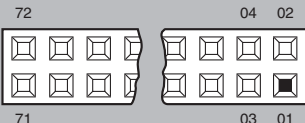

Specify “XX” as position. For Double the same position will be polarized on both ends. (Not available on IDM or EDM, unless transfer, then only the socket is polarized.)

2

—B “XX”

= Breakout

Specify “XX” as number of conductors to be broken out.

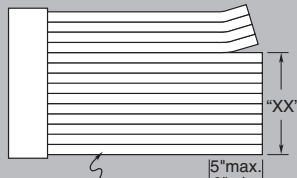

Breakout starts with Number 1 lead indicated by brown wire or red stripe. Shown on top side.

5

—D “XX”

= Daisy Chain, Double

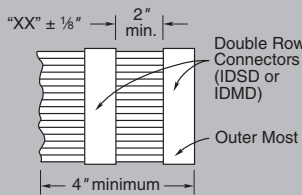

7

—M

= Middle Reversed

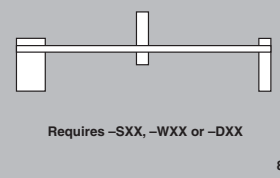

8

—G

= Gray Cable

Specify —G for Gray cable. Gray cable has one red edge. IDSS and IDMS uses .100" centerline cable. IDSD and IDMD uses .050" centerline cable. Cable is 28 AWG 7/36 copper wire. Standard cable is same as above except color coded.

3

—RW

= Reversed Wiring

#1 wire opposite position #1.

6

—W “XX”

= Wiring Reversed Daisy Chain, Single

Same as —S “XX” except outer strip connected to Conductor #2 and inside strip connected to Conductor #1.

7

—O

= Outside Reversed

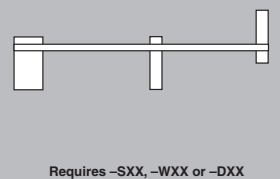

8

Due to technical progress, all designs, specifications and components are subject to change without notice.

[WWW.SAMTEC.COM](http://WWW.SAMTEC.COM)

# Mouser Electronics

Authorized Distributor

Click to View Pricing, Inventory, Delivery & Lifecycle Information:

[Samtec:](#)

[IDSD-05-D-15.50-G-D02](#) [IDSD-09-S-78.74](#)