

PCB LAYOUT - COMPONENT VIEW

TECHNICAL CHARACTERISTICS

MATERIAL
 INSULATOR MATERIAL: PBT
 FLAMMABILITY RATING: UL94-V0
 COLOR: BLACK
 CONTACT MATERIAL: COPPER ALLOY
 CONTACT TYPE: STAMPED
 CONTACT PLATING: GOLD
 QUALITY CLASS: 500 MATING CYCLES

ENVIRONMENTAL
 OPERATING TEMPERATURE: -25 °C UP TO 85 °C
 COMPLIANCE: LEAD FREE AND ROHS

ELECTRICAL
 CURRENT RATING: 1.5 A
 WORKING VOLTAGE: 120 VAC
 INSULATION RESISTANCE: >500 MΩ
 DIELECTRIC WITHSTANDING VOLTAGE: 1 000 VAC/MIN
 CONTACT RESISTANCE: 20 mΩ MAX

SOLDERING
 JEDEC LEAD FREE WAVE SOLDERING PROCESS

PACKAGING
 TRAY

RoHS Compliant			
G			
F			
E	28-JUL-14	GENERAL UPDATE	AS
D	03-JAN-14	TPK DWG ADD	QL
C	19-AUG-13	DIM CORRECTION	QL
B	02-JUN-09	NO SHIELD. MAT.	JP
A	03-NOV-08	PDF	CH
REV	DATE	FILE	BY

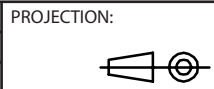

GENERAL TOLERANCE
 .X = +/- 0.2
 .XX = +/- 0.15



APPROVAL: RJ

UNIT: MM
 SCALE:
 SHEET: 1/1
 DRAW:

DESCRIPTION: VERTICAL PLASTIC 6P6C MODULAR JACK
 WERI PART NO: 615 006 144 121

SIZE
A4

A

B

C

D

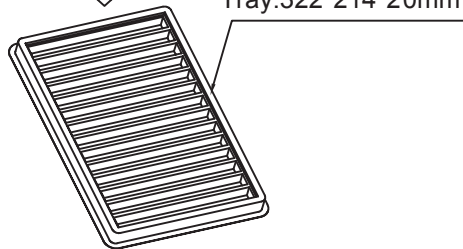
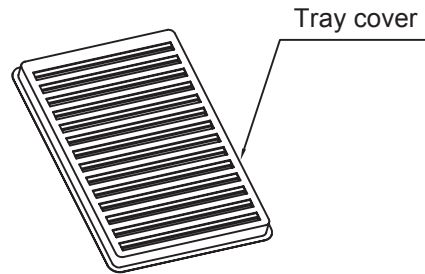

Partition:45*34cm
Top and bottom of pile are placed with 1 partition

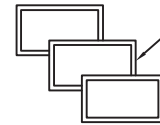
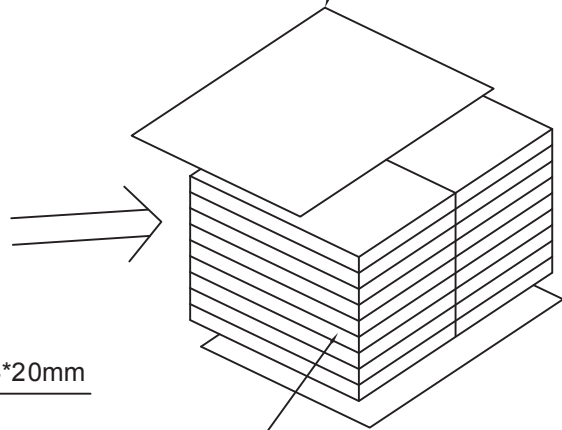

Waterproof Bag:45*35*57cm
1pc/carton

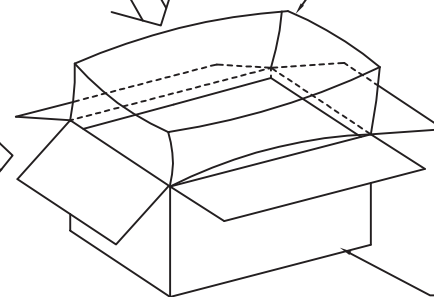

Packaging Qty		
168 pcs/tray	18 trays/carton	3024 pcs/carton

RoHS Compliant			
G			
F			
E			
D			
C			
B			
A			
REV	DATE	FILE	BY

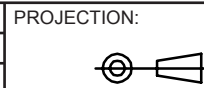

GENERAL TOLERANCE
.X = +/- 0.2
.XX = +/- 0.15



APPROVAL: RJ

UNIT: MM
SCALE:
SHEET: 1/1
DRAW:

DESCRIPTION: VERTICAL PLASTIC 6P6C MODULAR JACK
WERI PART NO: 615 006 144 121

SIZE
A4

A

B

C

D

Mouser Electronics

Authorized Distributor

Click to View Pricing, Inventory, Delivery & Lifecycle Information:

[Wurth Electronics:](#)

[615006144121](#)