

# TLV2760, TLV2761, TLV2762, TLV2763, TLV2764, TLV2765 FAMILY OF 1.8 V MICROPOWER RAIL-TO-RAIL INPUT/OUTPUT OPERATIONAL AMPLIFIERS WITH SHUTDOWN

SLOS326F – JUNE 2000 – REVISED AUGUST 2013

- Low Supply Voltage . . . 1.8 V to 3.6 V
- Very Low Supply Current . . . 20  $\mu$ A (per channel)
- Ultralow Power Shut-Down Mode
  - $I_{DD(SHDN)} = 10$  nA/Channel
- CMOS Rail-to-Rail Input/Output
- Input Common-Mode Voltage Range . . .  $-0.2$  V to  $V_{DD} + 0.2$  V
- Input Offset Voltage . . . 550  $\mu$ V
- Wide Bandwidth . . . 500 kHz
- Slew Rate . . . 0.20 V/ $\mu$ s
- Specified Temperature Range:
  - 0°C to 70°C . . . Commercial Grade
  - 40°C to 85°C . . . Industrial Grade
- Ultrasmall Packaging
  - 5 or 6 Pin SOT-23 (TLV2760/1)
  - 8 or 10 Pin MSOP (TLV2762/3)
- Universal Op-Amp EVM

Operational Amplifier

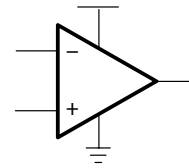

SUPPLY CURRENT  
vs  
SUPPLY VOLTAGE

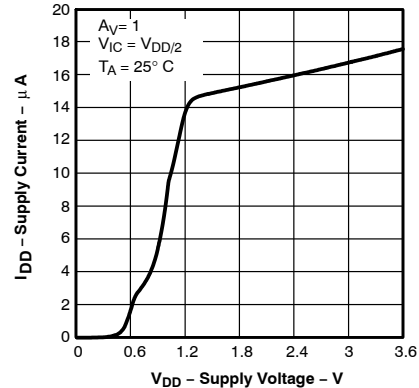

## description

The TLV276x single supply operational amplifiers provide 500 kHz bandwidth from only 20  $\mu$ A while operating down to 1.8 V over the industrial temperature range. The maximum recommended supply voltage is 3.6 V, which allows the devices to be operated from ( $\pm 1.8$  V supplies down to  $\pm 0.9$  V) two AA or AAA cells. The devices have been characterized at 1.8 V (end of life of 2 AA(A) cells) and at 2.4 V (nominal voltage of 2 NiCd/NiMH cells). The TLV276x have rail-to-rail input and output capability which is a necessity at 1.8 V.

The low supply current is coupled with extremely low input bias currents enabling them to be used with mega-ohm resistors. Low shutdown current of only 10 nA make these devices ideal for low frequency measurement applications desiring long active battery life.

All members are available in PDIP and SOIC with the singles in the small SOT-23 package, duals in the MSOP, and quads in the TSSOP package.

### SELECTION OF SINGLE SUPPLY AMPLIFIER PRODUCTS

| DEVICE     | $V_{DD}$<br>(V) | $V_{IO}$<br>( $\mu$ V) | $I_{DD/Ch}$<br>( $\mu$ A) | $I_{IB}$<br>(pA) | GBW<br>(MHz) | SR<br>(V/ $\mu$ s) | $V_n$ ,1kHz<br>(nV/ $\sqrt$ Hz) | $I_o$<br>(mA) | SHUT-<br>DOWN | RAIL-TO-<br>RAIL |
|------------|-----------------|------------------------|---------------------------|------------------|--------------|--------------------|---------------------------------|---------------|---------------|------------------|
| TLV224x    | 2.5 – 12        | 600                    | 1                         | 100              | 0.0055       | 0.002              | NA                              | 0.2           | —             | I/O              |
| TLV2211    | 2.7 – 10        | 450                    | 13                        | 1                | 0.065        | 0.025              | 21                              | 0.4           | —             | O                |
| TLV276x    | 1.8 – 3.6       | 550                    | 20                        | 3                | 0.5          | 0.23               | 95                              | 5             | Y             | I/O              |
| TLV245x(A) | 2.7 – 6         | 20                     | 23                        | 500              | 0.22         | 0.11               | 49                              | 2.5           | Y             | I/O              |
| TLV246x(A) | 2.7 – 6         | 150                    | 550                       | 1300             | 6.4          | 1.6                | 11                              | 25            | Y             | I/O              |
| TLV278x(A) | 1.8 – 3.6       | 250                    | 650                       | 2.5              | 8            | 5                  | 18                              | 10            | Y             | I/O              |



Please be aware that an important notice concerning availability, standard warranty, and use in critical applications of Texas Instruments semiconductor products and disclaimers thereto appears at the end of this data sheet.

PRODUCTION DATA information is current as of publication date. Products conform to specifications per the terms of Texas Instruments standard warranty. Production processing does not necessarily include testing of all parameters.

**TEXAS  
INSTRUMENTS**

POST OFFICE BOX 655303 • DALLAS, TEXAS 75265

Copyright © 2000–2013, Texas Instruments Incorporated

# TLV2760, TLV2761, TLV2762, TLV2763, TLV2764, TLV2765 FAMILY OF 1.8 V MICROPOWER RAIL-TO-RAIL INPUT/OUTPUT OPERATIONAL AMPLIFIERS WITH SHUTDOWN

SLOS326F – JUNE 2000 – REVISED AUGUST 2013

## TLV2760 and TLV2761 AVAILABLE OPTIONS<sup>(1)</sup>

| T <sub>A</sub> | V <sub>IOmax</sub><br>AT 25°C | PACKAGED DEVICES                  |                            |              |                        |
|----------------|-------------------------------|-----------------------------------|----------------------------|--------------|------------------------|
|                |                               | SMALL OUTLINE<br>(D) <sup>†</sup> | SOT-23                     |              | PLASTIC DIP<br>(P)     |
|                |                               |                                   | (DBV) <sup>‡</sup>         | SYMBOL       |                        |
| 0°C to 70°C    | 3500 μV                       | TLV2760CD<br>TLV2761CD            | —<br>—                     | —<br>—       | —<br>—                 |
| –40°C to 85°C  | 3500 μV                       | TLV2760ID<br>TLV2761ID            | TLV2760IDBV<br>TLV2761IDBV | VANI<br>VAXI | TLV2760IP<br>TLV2761IP |

<sup>†</sup> This package is available taped and reeled. To order this packaging option, add an **R** suffix to the part number (e.g., TLV2760CDR).

<sup>‡</sup> This package is only available taped and reeled. For standard quantities (3,000 pieces per reel), add an **R** suffix (i.e., TLV2760CDBVR). For smaller quantities (250 pieces per mini-reel), add a **T** suffix to the part number (e.g., TLV2760CDBVT).

## TLV2762 and TLV2763 AVAILABLE OPTIONS<sup>(1)</sup>

| T <sub>A</sub> | V <sub>IOmax</sub><br>AT 25°C | PACKAGED DEVICES                  |                  |              |                  |              |                     |                    |
|----------------|-------------------------------|-----------------------------------|------------------|--------------|------------------|--------------|---------------------|--------------------|
|                |                               | SMALL OUTLINE<br>(D) <sup>†</sup> | MSOP             |              |                  |              | PLASTIC DIP<br>(N)  | PLASTIC DIP<br>(P) |
|                |                               |                                   | DGK <sup>†</sup> | SYMBOL       | DGS <sup>†</sup> | SYMBOL       |                     |                    |
| 0°C to 70°C    | 3500 μV                       | TLV2762CD<br>TLV2763CD            | —<br>TLV2762CDGK | —<br>AJO     | —<br>—           | —<br>—       | —<br>—              |                    |
| –40°C to 85°C  | 3500 μV                       | TLV2762ID<br>TLV2763ID            | TLV2762IDGK<br>— | xxTIAJP<br>— | —<br>TLV2763IDGS | —<br>xxTIAJR | —<br>TLV2762IP<br>— |                    |

<sup>†</sup> This package is available taped and reeled. To order this packaging option, add an **R** suffix to the part number (e.g., TLV2762CDR).

## TLV2764 and TLV2765 AVAILABLE OPTIONS<sup>(1)</sup>

| T <sub>A</sub> | V <sub>IOmax</sub><br>AT 25°C | PACKAGED DEVICES                  |                        |                            |
|----------------|-------------------------------|-----------------------------------|------------------------|----------------------------|
|                |                               | SMALL OUTLINE<br>(D) <sup>†</sup> | PLASTIC DIP<br>(N)     | TSSOP<br>(PW) <sup>†</sup> |
| 0°C to 70°C    | 3500 μV                       | TLV2764CD<br>TLV2765CD            | —<br>—                 | —<br>—                     |
| –40°C to 85°C  | 3500 μV                       | TLV2764ID<br>TLV2765ID            | TLV2764IN<br>TLV2765IN | TLV2764IPW<br>TLV2765IPW   |

<sup>†</sup> This package is available taped and reeled. To order this packaging option, add an **R** suffix to the part number (e.g., TLV2764CDR).

1. For the most current package and ordering information, see the Package Option Addendum at the end of this document, or see the TI website at [www.ti.com](http://www.ti.com).



# TLV2760, TLV2761, TLV2762, TLV2763, TLV2764, TLV2765 FAMILY OF 1.8 V MICROPOWER RAIL-TO-RAIL INPUT/OUTPUT OPERATIONAL AMPLIFIERS WITH SHUTDOWN

SLOS326F – JUNE 2000 – REVISED AUGUST 2013

## TLV276x PACKAGE PINOUTS

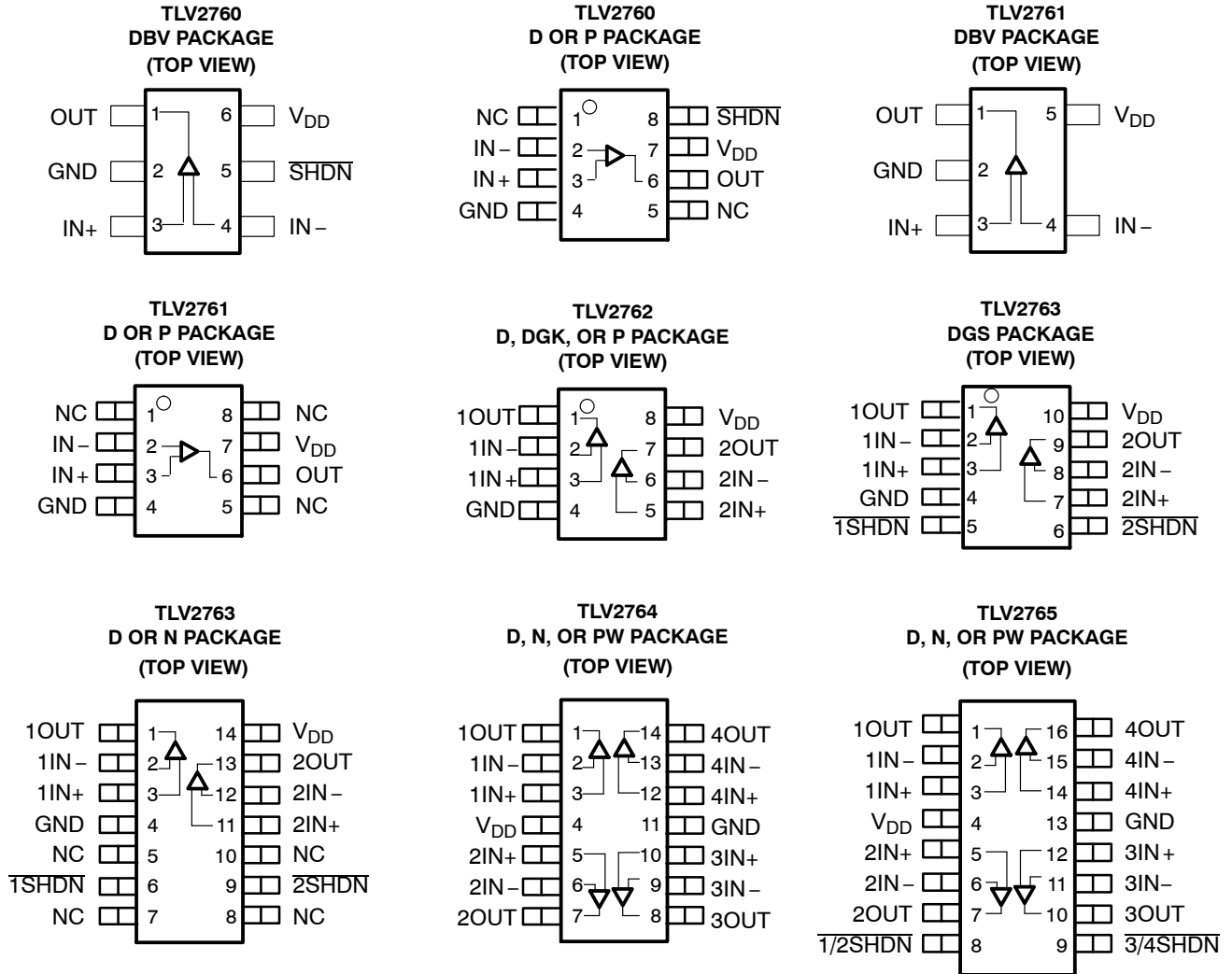

NC – No internal connection

# TLV2760, TLV2761, TLV2762, TLV2763, TLV2764, TLV2765 FAMILY OF 1.8 V MICROPOWER RAIL-TO-RAIL INPUT/OUTPUT OPERATIONAL AMPLIFIERS WITH SHUTDOWN

SLOS326F – JUNE 2000 – REVISED AUGUST 2013

## absolute maximum ratings over operating free-air temperature range (unless otherwise noted)<sup>†</sup>

|  |                              |
|--|------------------------------|
| Supply voltage, $V_{DD}$ (see Note 1)                        | 4 V                          |
| Differential input voltage range, $V_{ID}$                   | $\pm V_{DD}$                 |
| Input current range, $I_I$                                   | $\pm 10$ mA                  |
| Output current range, $I_O$                                  | $\pm 10$ mA                  |
| Continuous total power dissipation                           | See Dissipation Rating Table |
| Operating free-air temperature range, $T_A$ : C-suffix       | 0°C to 70°C                  |
| I-suffix   | -40°C to 85°C                |
| Maximum junction temperature, $T_J$                          | 150°C                        |
| Storage temperature range, $T_{stg}$                         | -65°C to 150°C               |
| Lead temperature 1,6 mm (1/16 inch) from case for 10 seconds | 260°C                        |

<sup>†</sup> Stresses beyond those listed under “absolute maximum ratings” may cause permanent damage to the device. These are stress ratings only, and functional operation of the device at these or any other conditions beyond those indicated under “recommended operating conditions” is not implied. Exposure to absolute-maximum-rated conditions for extended periods may affect device reliability.

NOTE 1: All voltage values, except differential voltages, are with respect to GND

DISSIPATION RATING TABLE

| PACKAGE   | $\Theta_{JC}$<br>(°C/W) | $\Theta_{JA}$<br>(°C/W) | $T_A \leq 25^\circ\text{C}$<br>POWER RATING | $T_A = 85^\circ\text{C}$<br>POWER RATING |
|-----------|-------------------------|-------------------------|---|--|
| D (8)     | 38.3                    | 176                     | 710 mW                                      | 369 mW                                   |
| D (14)    | 26.9                    | 122                     | 1022 mW                                     | 531 mW                                   |
| D (16)    | 25.7                    | 114                     | 1090 mW                                     | 567 mW                                   |
| DBV (5)   | 55                      | 324                     | 385 mW                                      | 201 mW                                   |
| DBV (6)   | 55                      | 294                     | 425 mW                                      | 221 mW                                   |
| DGK(8)    | 54.2                    | 260                     | 481 mW                                      | 250 mW                                   |
| DGS(10)   | 54.1                    | 258                     | 485 mW                                      | 252 mW                                   |
| N (14,16) | 32                      | 78                      | 1600 mW                                     | 833 mW                                   |
| P         | 41                      | 104                     | 1200 mW                                     | 625 mW                                   |
| PW (14)   | 29.3                    | 174                     | 720 mW                                      | 374 mW                                   |
| PW (16)   | 28.7                    | 161                     | 774 mW                                      | 403 mW                                   |

## recommended operating conditions

|  |               | MIN                       | MAX            | UNIT |
|--|---------------|---------------------------|----------------|------|
| Supply voltage, $V_{DD}$                   | Single supply | 1.8                       | 3.6            | V    |
|  | Split supply  | $\pm 0.8$                 | $\pm 1.8$      |      |
| Common-mode input voltage range, $V_{ICR}$ |               | -0.2                      | $V_{DD} + 0.2$ | V    |
| Operating free-air temperature, $T_A$      | C-suffix      | 0                         | 70             | °C   |
|  | I-suffix      | -40                       | 85             |      |
| Shutdown on/off voltage level (see Note 2) | $V_{IH}$      | $V_{DD} < 2.7$ V          | $0.75 V_{DD}$  | V    |
|  |               | $V_{DD} = 2.7$ to $3.6$ V | 2              |      |
|  | $V_{IL}$      |                           | 0.6            |      |

NOTE 2: Relative to GND



# TLV2760, TLV2761, TLV2762, TLV2763, TLV2764, TLV2765 FAMILY OF 1.8 V MICROPOWER RAIL-TO-RAIL INPUT/OUTPUT OPERATIONAL AMPLIFIERS WITH SHUTDOWN

SLOS326F – JUNE 2000 – REVISED AUGUST 2013

electrical characteristics at recommended operating conditions,  $V_{DD} = 1.8\text{ V}, 2.4\text{ V}$  (unless otherwise noted)

## dc performance

| PARAMETER                             |   | TEST CONDITIONS  | $T_A^\dagger$           | MIN        | TYP | MAX  | UNIT                         |
|---------------------------------------|---|--|-------------------------|------------|-----|------|------------------------------|
| $V_{IO}$                              | Input offset voltage                                      | $V_{IC} = V_{DD}/2,$<br>$V_O = V_{DD}/2,$<br>$R_L = 300\text{ k}\Omega,$<br>$R_S = 50\ \Omega$ | TLV276x                 | 25°C       | 550 | 3500 | $\mu\text{V}$                |
|                                       |   |  |                         | Full range |     | 6800 |                              |
| $\alpha_{VIO}$                        | Offset voltage drift                                      |  |                         |            | 9   |      | $\mu\text{V}/^\circ\text{C}$ |
| CMRR                                  | Common-mode rejection ratio                               | $V_{ICR} = 0\text{ V to }V_{DD},$<br>$R_S = 50\ \Omega$  | $V_{DD} = 1.8\text{ V}$ | 25°C       | 50  | 70   | dB                           |
|                                       |   |  |                         | Full range | 48  |      |                              |
|                                       |   |  | $V_{DD} = 2.4\text{ V}$ | 25°C       | 53  | 72   | dB                           |
|                                       |   |  |                         | Full range | 50  |      |                              |
|                                       |   |  | $V_{DD} = 3.6\text{ V}$ | 25°C       | 55  | 76   | dB                           |
|                                       |   |  |                         | Full range | 55  |      |                              |
| $V_{DD} = 2.4\text{ V}, 3.6\text{ V}$ | $V_{ICR} = 1.2\text{ V to }V_{DD},$<br>$R_S = 50\ \Omega$ | 25°C   | 63                      | 82         | dB  |      |                              |
|                                       |   | Full range   | 60                      |            |     |      |                              |
| $A_{VD}$                              | Large-signal differential voltage amplification           | $R_L = 10\text{ k}\Omega,$<br>$V_{O(PP)} = V_{DD}/2$   | $V_{DD} = 1.8\text{ V}$ | 25°C       | 20  | 60   | V/mV                         |
|                                       |   |  |                         | Full range | 18  |      |                              |
|                                       |   |  | $V_{DD} = 2.4\text{ V}$ | 25°C       | 28  | 78   | V/mV                         |
|                                       |   |  |                         | Full range | 23  |      |                              |
|                                       |   |  | $V_{DD} = 3.6\text{ V}$ | 25°C       | 45  | 120  | V/mV                         |
|                                       |   |  |                         | Full range | 37  |      |                              |

$^\dagger$  Full range is 0°C to 70°C for the C-suffix and –40°C to 85°C for the I-suffix. If not specified, full range is –40°C to 85°C.

## input characteristics

| PARAMETER  |                               | TEST CONDITIONS  | $T_A^\dagger$ | MIN        | TYP  | MAX | UNIT       |
|------------|-------------------------------|--|---------------|------------|------|-----|------------|
| $I_{IO}$   | Input offset current          | $V_{IC} = V_{DD}/2,$<br>$V_O = V_{DD}/2,$<br>$R_L = 300\text{ k}\Omega,$<br>$R_S = 50\ \Omega$ |               | 25°C       | 3    | 15  | pA         |
|            |                               |  | TLV276xC      | Full range |      | 100 |            |
|            |                               |  | TLV276xI      | Full range |      | 200 |            |
| $I_{IB}$   | Input bias current            | $R_L = 300\text{ k}\Omega,$<br>$R_S = 50\ \Omega$  |               | 25°C       | 3    | 15  | pA         |
|            |                               |  | TLV276xC      | Full range |      | 100 |            |
|            |                               |  | TLV276xI      | Full range |      | 200 |            |
| $r_{i(d)}$ | Differential input resistance |  | 25°C          |            | 1000 |     | G $\Omega$ |
| $C_{i(c)}$ | Common-mode input capacitance | $f = 16\text{ kHz}$  | 25°C          |            | 10   |     | pF         |

$^\dagger$  Full range is 0°C to 70°C for the C-suffix and –40°C to 85°C for the I-suffix. If not specified, full range is –40°C to 85°C.

**TLV2760, TLV2761, TLV2762, TLV2763, TLV2764, TLV2765**  
**FAMILY OF 1.8 V MICROPOWER RAIL-TO-RAIL INPUT/OUTPUT**  
**OPERATIONAL AMPLIFIERS WITH SHUTDOWN**

SLOS326F – JUNE 2000 – REVISED AUGUST 2013

electrical characteristics at recommended operating conditions,  $V_{DD} = 1.8\text{ V}, 2.4\text{ V}$  (unless otherwise noted) (continued)

**output characteristics**

| PARAMETER                             | TEST CONDITIONS                                       |                         | $T_A^\dagger$ | MIN   | TYP  | MAX | UNIT |
|---------------------------------------|---|-------------------------|---------------|-------|------|-----|------|
| $V_{OH}$ High-level output voltage    | $V_{IC} = V_{DD}/2,$<br>$I_{OH} = -100\ \mu\text{A}$  | $V_{DD} = 1.8\text{ V}$ | 25°C          | 1.77  | 1.79 |     | V    |
|                                       |   |                         | Full range    | 1.76  |      |     |      |
|                                       |   | $V_{DD} = 2.4\text{ V}$ | 25°C          | 2.38  | 2.39 |     |      |
|                                       |   |                         | Full range    | 2.37  |      |     |      |
|                                       |   | $V_{DD} = 3.6\text{ V}$ | 25°C          | 3.58  | 3.59 |     |      |
|                                       |   |                         | Full range    | 3.57  |      |     |      |
|                                       | $V_{IC} = V_{DD}/2,$<br>$I_{OH} = -500\ \mu\text{A}$  | $V_{DD} = 1.8\text{ V}$ | 25°C          | 1.725 | 1.75 |     |      |
|                                       |   |                         | Full range    | 1.7   |      |     |      |
|                                       |   | $V_{DD} = 2.4\text{ V}$ | 25°C          | 2.325 | 2.35 |     |      |
|                                       |   |                         | Full range    | 2.3   |      |     |      |
|                                       |   | $V_{DD} = 3.6\text{ V}$ | 25°C          | 3.525 | 3.55 |     |      |
|                                       |   |                         | Full range    | 3.5   |      |     |      |
| $V_{OL}$ Low-level output voltage     | $V_{IC} = V_{DD}/2,$<br>$I_{OL} = 100\ \mu\text{A}$   | 25°C                    |               | 10    | 20   | mV  |      |
|                                       |   | Full range              |               |       | 30   |     |      |
|                                       | $V_{IC} = V_{DD}/2,$<br>$I_{OL} = 500\ \mu\text{A}$   | 25°C                    |               | 50    | 75   |     |      |
|                                       |   | Full range              |               |       | 100  |     |      |
| $I_O$ Output current                  | $V_{DD} = 1.8\text{ V},$<br>$V_O = 0.5\text{ V from}$ | Positive rail           | 25°C          | 4.8   |      | mA  |      |
|                                       |   | Negative rail           |               | 7.2   |      |     |      |
|                                       | $V_{DD} = 2.4\text{ V},$<br>$V_O = 0.5\text{ V from}$ | Positive rail           | 25°C          | 7.3   |      |     |      |
|                                       |   | Negative rail           |               | 10.2  |      |     |      |
| $I_{OS}$ Short-circuit output current | $V_{DD} = 1.8\text{ V}$                               | Sourcing                | 25°C          | 7     |      | mA  |      |
|                                       |   | Sinking                 |               | 10    |      |     |      |
|                                       | $V_{DD} = 2.4\text{ V}$                               | Sourcing                | 25°C          | 15    |      |     |      |
|                                       |   | Sinking                 |               | 19    |      |     |      |

† Full range is 0°C to 70°C for the C-suffix and -40°C to 85°C for the I-suffix. If not specified, full range is -40°C to 85°C.

**power supply,  $V_{DD} = 1.8\text{ V}, 2.4\text{ V}, 3.6\text{ V}$  (unless otherwise noted)**

| PARAMETER   | TEST CONDITIONS  |            | $T_A^\dagger$ | MIN | TYP | MAX | UNIT          |
|---|--|------------|---------------|-----|-----|-----|---------------|
| $I_{DD}$ Supply current (per channel)   | $V_O = V_{DD}/2,$<br>$\overline{\text{SHDN}} = V_{DD}$           | 25°C       |               | 20  | 28  |     | $\mu\text{A}$ |
|   |  | Full range |               |     |     | 30  |               |
| $k_{SVR}$ Supply voltage rejection ratio<br>( $\Delta V_{DD} / \Delta V_{IO}$ ) | $V_{DD} = 1.8\text{ V to } 2.4\text{ V},$<br>$V_{IC} = V_{DD}/2$ | No load    | 25°C          | 65  | 85  |     | dB            |
|   |  |            | Full range    | 63  |     |     |               |
|   | $V_{DD} = 2.4\text{ V to } 3.6\text{ V},$<br>$V_{IC} = V_{DD}/2$ | 25°C       | 65            | 85  |     |     |               |
|   |  | Full range | 63            |     |     |     |               |
|   | $V_{DD} = 1.8\text{ V to } 3.6\text{ V},$<br>$V_{IC} = V_{DD}/2$ | 25°C       | 65            | 85  |     |     |               |
|   |  | Full range | 63            |     |     |     |               |

† Full range is 0°C to 70°C for the C-suffix and -40°C to 85°C for the I-suffix. If not specified, full range is -40°C to 85°C.



**TLV2760, TLV2761, TLV2762, TLV2763, TLV2764, TLV2765**  
**FAMILY OF 1.8 V MICROPOWER RAIL-TO-RAIL INPUT/OUTPUT**  
**OPERATIONAL AMPLIFIERS WITH SHUTDOWN**

SLOS326F – JUNE 2000 – REVISED AUGUST 2013

electrical characteristics at recommended operating conditions,  $V_{DD} = 1.8\text{ V}, 2.4\text{ V}$  (unless otherwise noted) (continued)

**dynamic performance**

| PARAMETER |                                  | TEST CONDITIONS   |                         | $T_A^\dagger$      | MIN  | TYP      | MAX           | UNIT             |
|-----------|----------------------------------|---|-------------------------|--------------------|------|----------|---------------|------------------|
| UGBW      | Unity gain bandwidth             | $R_L = 300\text{ k}\Omega,$   | $C_L = 10\text{ pF}$    | $25^\circ\text{C}$ |      | 500      |               | kHz              |
| SR+       | Positive slew rate at unity gain | $V_{O(PP)} = 1\text{ V}, R_L = 300\text{ k}\Omega,$<br>$C_L = 50\text{ pF},$                                    | $V_{DD} = 1.8\text{ V}$ | $25^\circ\text{C}$ | 0.11 | 0.20     |               | V/ $\mu\text{s}$ |
|           |                                  |   |                         | Full range         | 0.09 |          |               |                  |
|           |                                  |   | $V_{DD} = 2.4\text{ V}$ | $25^\circ\text{C}$ | 0.11 | 0.22     |               | V/ $\mu\text{s}$ |
|           |                                  |   |                         | Full range         | 0.09 |          |               |                  |
|           |                                  |   | $V_{DD} = 3.6\text{ V}$ | $25^\circ\text{C}$ | 0.11 | 0.23     |               | V/ $\mu\text{s}$ |
|           |                                  |   |                         | Full range         | 0.09 |          |               |                  |
| SR-       | Negative slew rate at unity gain | $V_{O(PP)} = 1\text{ V}, R_L = 300\text{ k}\Omega,$<br>$C_L = 50\text{ pF},$                                    | $V_{DD} = 1.8\text{ V}$ | $25^\circ\text{C}$ | 0.08 | 0.15     |               | V/ $\mu\text{s}$ |
|           |                                  |   |                         | Full range         | 0.07 |          |               |                  |
|           |                                  |   | $V_{DD} = 2.4\text{ V}$ | $25^\circ\text{C}$ | 0.10 | 0.18     |               | V/ $\mu\text{s}$ |
|           |                                  |   |                         | Full range         | 0.09 |          |               |                  |
|           |                                  |   | $V_{DD} = 3.6\text{ V}$ | $25^\circ\text{C}$ | 0.10 | 0.22     |               | V/ $\mu\text{s}$ |
|           |                                  |   |                         | Full range         | 0.09 |          |               |                  |
| $\phi_m$  | Phase margin                     | $R_L = 300\text{ k}\Omega,$   | $C_L = 100\text{ pF}$   | $25^\circ\text{C}$ |      | 63       |               | $^\circ$         |
|           | Gain margin                      |   |                         | $25^\circ\text{C}$ |      | 20       |               | dB               |
| $t_s$     | Settling time                    | $V_{DD} = 1.8\text{ V}, V_{(STEP)PP} = 1\text{ V},$<br>$A_V = -1, C_L = 10\text{ pF}, R_L = 300\text{ k}\Omega$ | $0.1\%$                 | $25^\circ\text{C}$ |      | 6.4      | $\mu\text{s}$ |                  |
|           |                                  |   |                         |                    |      | $0.01\%$ |               | 13.7             |
|           |                                  | $V_{DD} = 2.4\text{ V}, V_{(STEP)PP} = 1\text{ V},$<br>$A_V = -1, C_L = 10\text{ pF}, R_L = 300\text{ k}\Omega$ | $0.1\%$                 |                    |      | 6        |               |                  |
|           |                                  |   |                         |                    |      | $0.01\%$ |               | 13.9             |

$^\dagger$  Full range is  $0^\circ\text{C}$  to  $70^\circ\text{C}$  for the C-suffix and  $-40^\circ\text{C}$  to  $85^\circ\text{C}$  for the I-suffix. If not specified, full range is  $-40^\circ\text{C}$  to  $85^\circ\text{C}$ .

**noise/distortion**

| PARAMETER |                                      | TEST CONDITIONS   |                    | $T_A$              | MIN | TYP   | MAX                    | UNIT |
|-----------|--------------------------------------|---|--------------------|--------------------|-----|-------|------------------------|------|
| THD + N   | Total harmonic distortion plus noise | $V_{DD} = 1.8\text{ V},$<br>$V_{O(PP)} = V_{DD}/2\text{ V},$<br>$R_L = 300\text{ k}\Omega,$<br>$f = 1\text{ kHz}$ | $A_V = 1$          | $25^\circ\text{C}$ |     | 0.08% |                        |      |
|           |                                      |   | $A_V = 10$         |                    |     | 0.10% |                        |      |
|           |                                      |   | $A_V = 100$        |                    |     | 0.27% |                        |      |
|           |                                      | $V_{DD} = 2.4\text{ V},$<br>$V_{O(PP)} = V_{DD}/2\text{ V},$<br>$R_L = 300\text{ k}\Omega,$<br>$f = 1\text{ kHz}$ | $A_V = 1$          | $25^\circ\text{C}$ |     | 0.06% |                        |      |
|           |                                      |   | $A_V = 10$         |                    |     | 0.08% |                        |      |
|           |                                      |   | $A_V = 100$        |                    |     | 0.24% |                        |      |
| $V_n$     | Equivalent input noise voltage       | $f = 1\text{ kHz}$  | $25^\circ\text{C}$ |                    | 95  |       | nV/ $\sqrt{\text{Hz}}$ |      |
|           |                                      | $f = 10\text{ kHz}$   | $25^\circ\text{C}$ |                    | 75  |       |                        |      |
| $I_n$     | Equivalent input noise current       | $f = 1\text{ kHz}$  | $25^\circ\text{C}$ |                    | 0.8 |       | fA/ $\sqrt{\text{Hz}}$ |      |

**shutdown characteristics**

| PARAMETER      |   | TEST CONDITIONS                       | $T_A^\dagger$      | MIN | TYP | MAX | UNIT          |
|----------------|---|---------------------------------------|--------------------|-----|-----|-----|---------------|
| $I_{DD(SHDN)}$ | Supply current, all channels in shutdown mode (TLV2760, TLV2763, TLV2765) (per channel) | $\overline{\text{SHDN}} = 0\text{ V}$ | $25^\circ\text{C}$ |     | 10  | 50  | nA            |
|                |   |                                       | Full range         |     |     | 400 |               |
| $t_{(on)}$     | Amplifier turnon time (see Note 3)  | $R_L = 300\text{ k}\Omega$            | $25^\circ\text{C}$ |     | 5   |     | $\mu\text{s}$ |
| $t_{(off)}$    | Amplifier turnoff time (see Note 3)   | $R_L = 300\text{ k}\Omega$            | $25^\circ\text{C}$ |     | 0.8 |     | $\mu\text{s}$ |

$^\dagger$  Full range is  $0^\circ\text{C}$  to  $70^\circ\text{C}$  for the C-suffix and  $-40^\circ\text{C}$  to  $85^\circ\text{C}$  for the I-suffix. If not specified, full range is  $-40^\circ\text{C}$  to  $85^\circ\text{C}$ .

NOTE 3: Disable time and enable time are defined as the interval between application of the logic signal to  $\overline{\text{SHDN}}$  and the point at which the supply current has reached half its final value.



**TLV2760, TLV2761, TLV2762, TLV2763, TLV2764, TLV2765**  
**FAMILY OF 1.8 V MICROPOWER RAIL-TO-RAIL INPUT/OUTPUT**  
**OPERATIONAL AMPLIFIERS WITH SHUTDOWN**

SLOS326F – JUNE 2000 – REVISED AUGUST 2013

**TYPICAL CHARACTERISTICS**

**Table of Graphs**

|                |  |                              | <b>FIGURE</b> |
|----------------|--|------------------------------|---------------|
| $V_{IO}$       | Input offset voltage                         | vs Common-mode input voltage | 1, 2          |
| CMRR           | Common-mode rejection ratio                  | vs Frequency                 | 3             |
| $V_{OH}$       | High-level output voltage                    | vs High-level output current | 4, 6          |
| $V_{OL}$       | Low-level output voltage                     | vs Low-level output current  | 5, 7          |
| $V_{O(PP)}$    | Maximum peak-to-peak output voltage          | vs Frequency                 | 8             |
| $I_{DD}$       | Supply current                               | vs Supply voltage            | 9             |
| $I_{DD}$       | Supply current                               | vs Free-air temperature      | 10            |
| PSRR           | Power supply rejection ratio                 | vs Frequency                 | 11            |
| $A_{VD}$       | Differential voltage amplification & phase   | vs Frequency                 | 12            |
|                | Gain-bandwidth product                       | vs Temperature               | 13            |
|                |  | vs Supply voltage            | 14            |
| SR             | Slew rate                                    | vs Supply voltage            | 15            |
|                |  | vs Free-air temperature      | 16, 17        |
| $\phi_m$       | Phase margin                                 | vs Load capacitance          | 18            |
| $V_n$          | Equivalent input noise voltage               | vs Frequency                 | 19            |
|                | Supply current and output voltage            | vs Time                      | 20            |
|                | Voltage-follower large-signal pulse response | vs Time                      | 21            |
|                | Voltage-follower small-signal pulse response | vs Time                      | 22            |
|                | Inverting large-signal response              | vs Time                      | 23            |
|                | Inverting small-signal response              | vs Time                      | 24            |
|                | Crosstalk                                    | vs Frequency                 | 25            |
|                | Shutdown forward & reverse isolation         | vs Frequency                 | 26            |
| $I_{DD(SHDN)}$ | Shutdown supply current                      | vs Supply voltage            | 27            |
| $I_{DD(SHDN)}$ | Shutdown supply current                      | vs Free-air temperature      | 28            |
| $I_{DD(SHDN)}$ | Shutdown pin leakage current                 | vs Shutdown pin voltage      | 29            |
| $I_{DD(SHDN)}$ | Shutdown supply current/output voltage       | vs Time                      | 30            |





# TLV2760, TLV2761, TLV2762, TLV2763, TLV2764, TLV2765 FAMILY OF 1.8 V MICROWPOWER RAIL-TO-RAIL INPUT/OUTPUT OPERATIONAL AMPLIFIERS WITH SHUTDOWN

SLOS326F – JUNE 2000 – REVISED AUGUST 2013

## TYPICAL CHARACTERISTICS

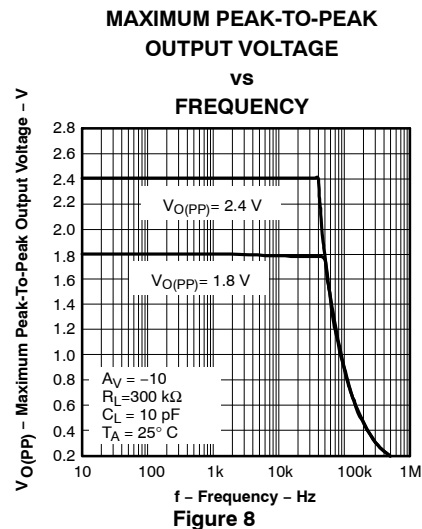
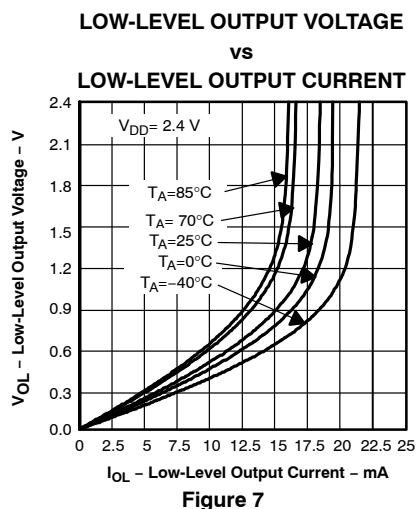
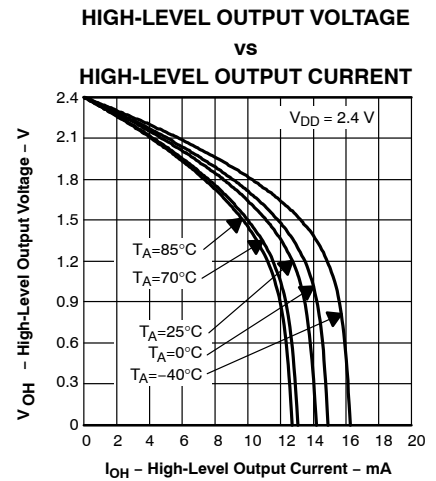
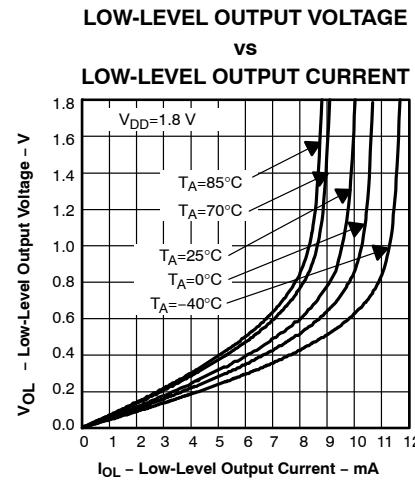
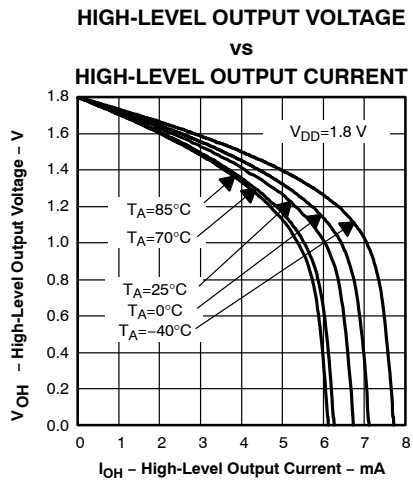
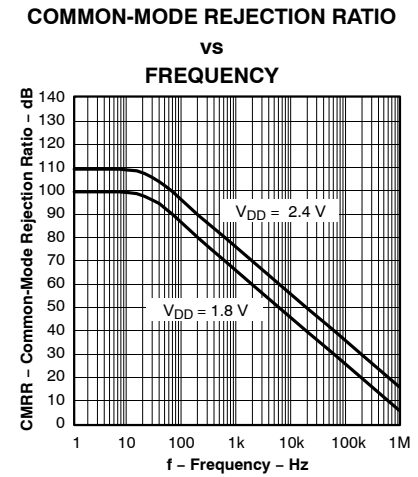
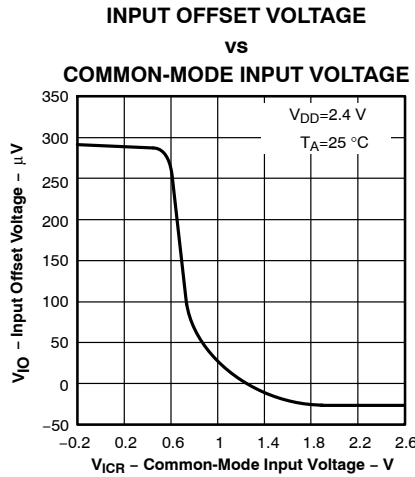
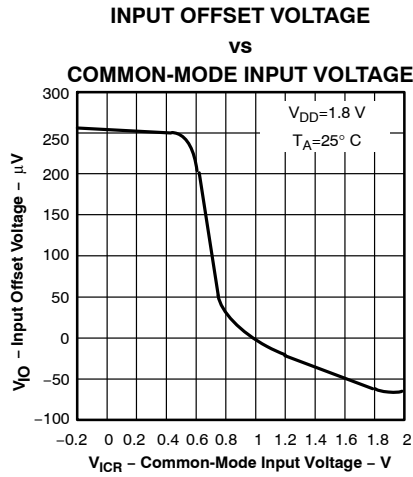

# TLV2760, TLV2761, TLV2762, TLV2763, TLV2764, TLV2765 FAMILY OF 1.8 V MICROWPOWER RAIL-TO-RAIL INPUT/OUTPUT OPERATIONAL AMPLIFIERS WITH SHUTDOWN

SLOS326F – JUNE 2000 – REVISED AUGUST 2013

## TYPICAL CHARACTERISTICS

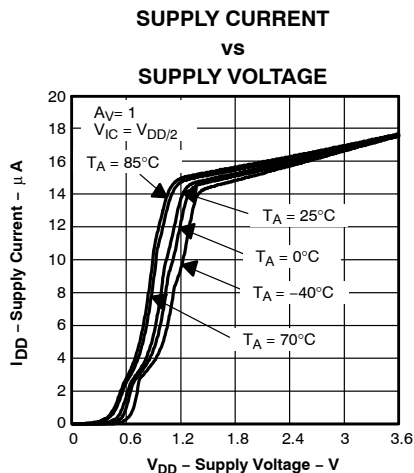

Figure 9

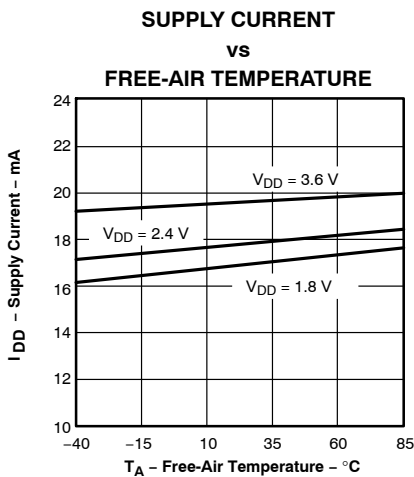

Figure 10

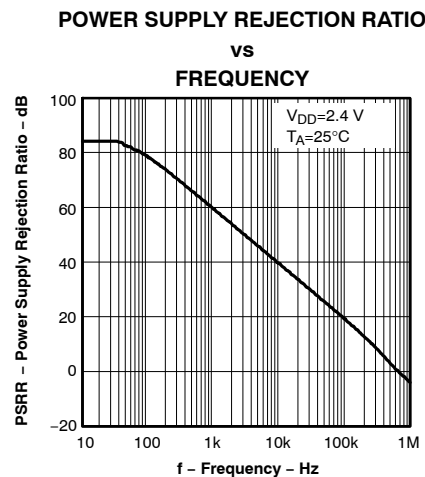

Figure 11

### DIFFERENTIAL VOLTAGE GAIN AND PHASE

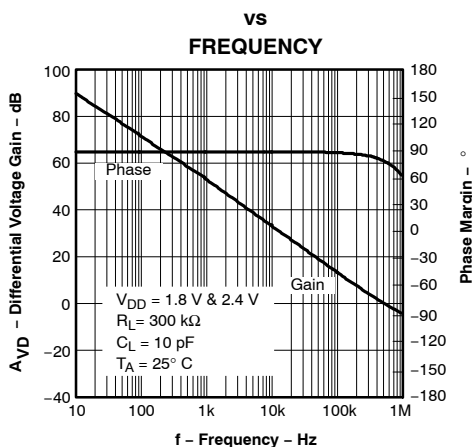

Figure 12

### GAIN BANDWIDTH PRODUCT

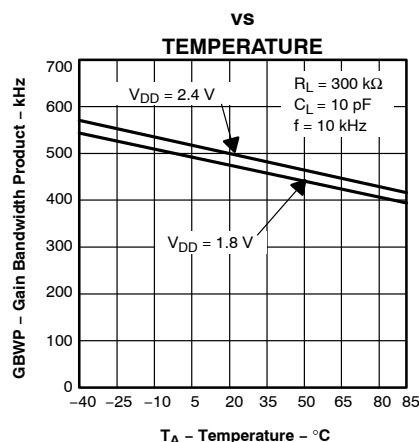

Figure 13

### GAIN-BANDWIDTH PRODUCT

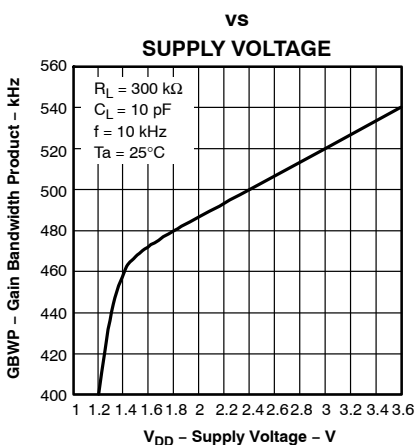

Figure 14

### SLEW RATE

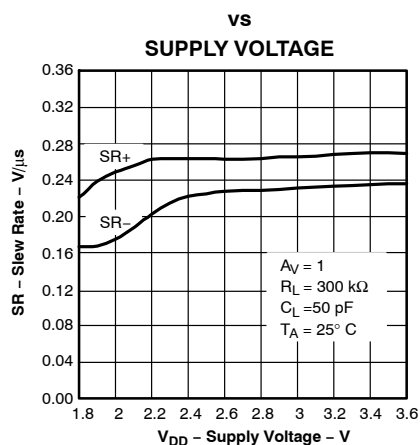

Figure 15



# TLV2760, TLV2761, TLV2762, TLV2763, TLV2764, TLV2765 FAMILY OF 1.8 V MICROWPOWER RAIL-TO-RAIL INPUT/OUTPUT OPERATIONAL AMPLIFIERS WITH SHUTDOWN

SLOS326F – JUNE 2000 – REVISED AUGUST 2013

## TYPICAL CHARACTERISTICS

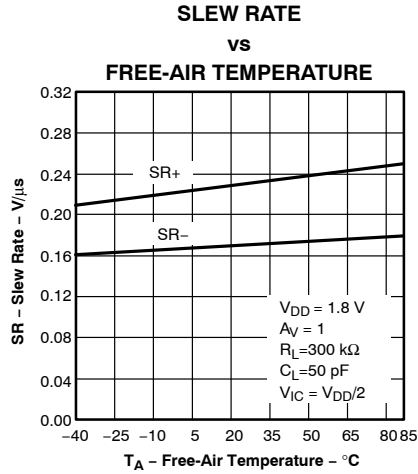

Figure 16

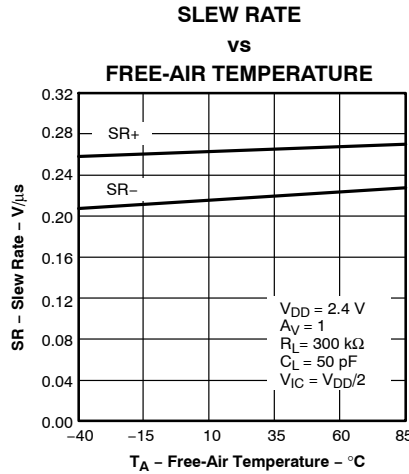

Figure 17

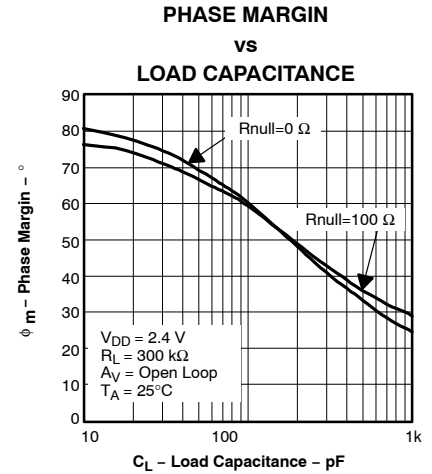

Figure 18

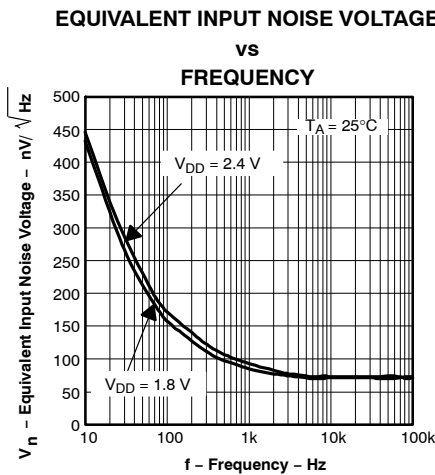

Figure 19

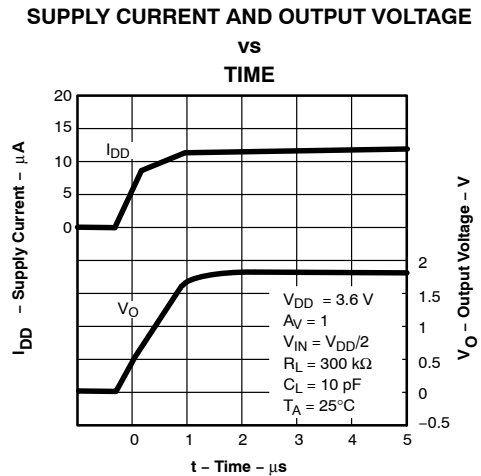

Figure 20

### VOLTAGE-FOLLOWER LARGE-SIGNAL PULSE RESPONSE

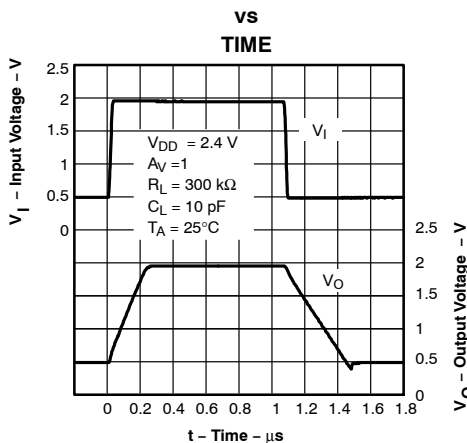

Figure 21

### VOLTAGE-FOLLOWER SMALL-SIGNAL PULSE RESPONSE

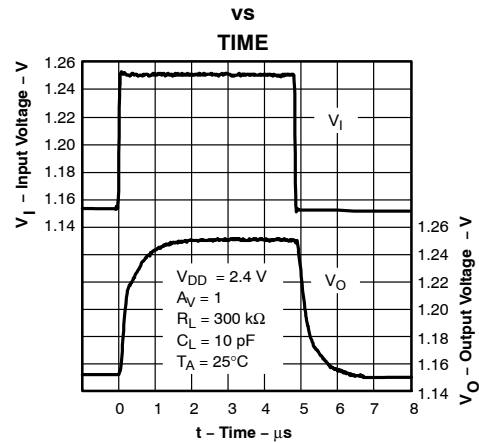

Figure 22

# TLV2760, TLV2761, TLV2762, TLV2763, TLV2764, TLV2765 FAMILY OF 1.8 V MICROPOWER RAIL-TO-RAIL INPUT/OUTPUT OPERATIONAL AMPLIFIERS WITH SHUTDOWN

SLOS326F – JUNE 2000 – REVISED AUGUST 2013

## TYPICAL CHARACTERISTICS

INVERTING LARGE-SIGNAL RESPONSE

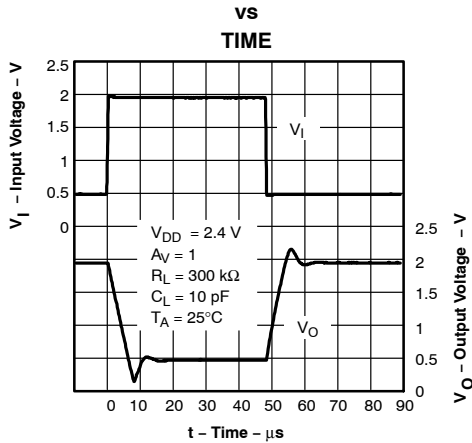

Figure 23

INVERTING SMALL-SIGNAL PULSE RESPONSE

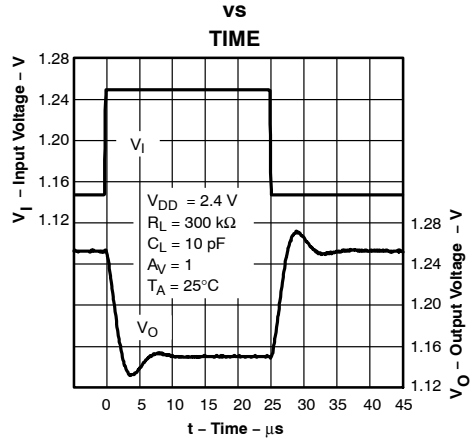

Figure 24

CROSSTALK  
vs  
FREQUENCY

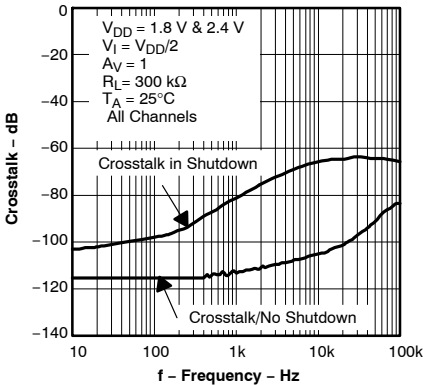

Figure 25

SHUTDOWN FORWARD AND  
REVERSE ISOLATION  
vs  
FREQUENCY

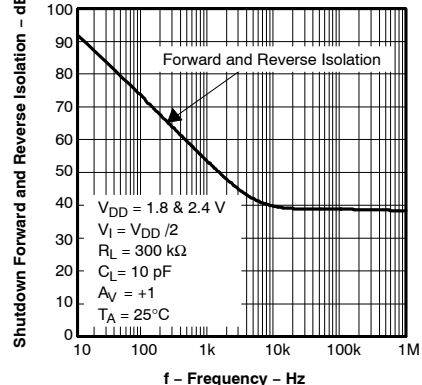

Figure 26

SHUTDOWN SUPPLY CURRENT  
vs  
SUPPLY VOLTAGE

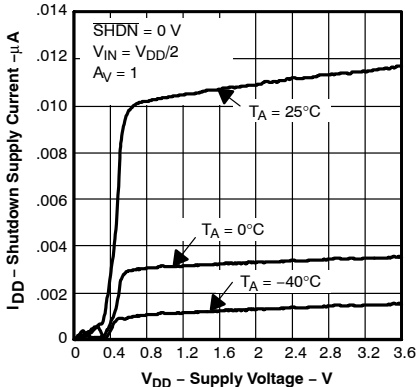

Figure 27

SHUTDOWN SUPPLY CURRENT  
vs  
FREE-AIR TEMPERATURE

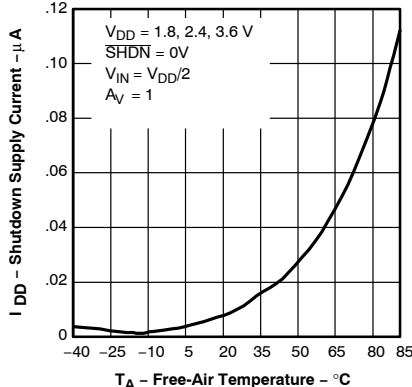

Figure 28

SHUTDOWN PIN LEAKAGE CURRENT  
vs  
SHUTDOWN PIN VOLTAGE

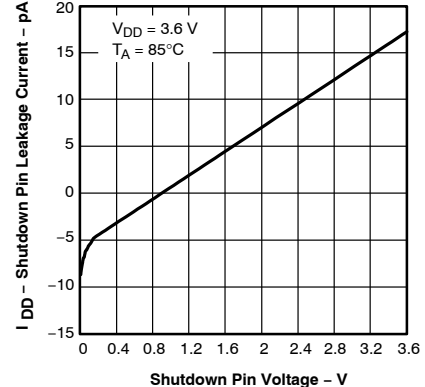

Figure 29



TLV2760, TLV2761, TLV2762, TLV2763, TLV2764, TLV2765  
FAMILY OF 1.8 V MICROPOWER RAIL-TO-RAIL INPUT/OUTPUT  
OPERATIONAL AMPLIFIERS WITH SHUTDOWN

SLOS326F - JUNE 2000 - REVISED AUGUST 2013

TYPICAL CHARACTERISTICS

SHUTDOWN SUPPLY CURRENT / OUTPUT VOLTAGE  
vs  
TIME

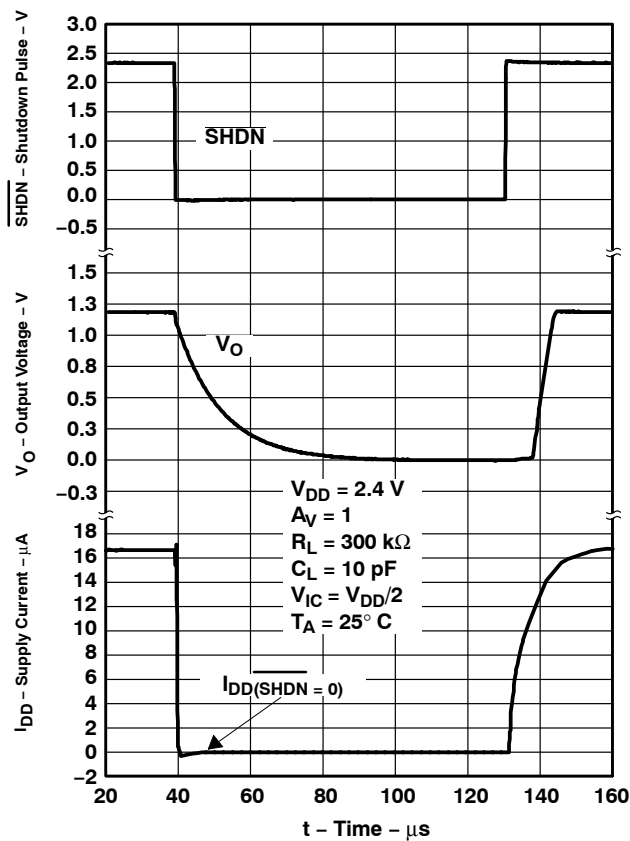

Figure 30

**TLV2760, TLV2761, TLV2762, TLV2763, TLV2764, TLV2765**  
**FAMILY OF 1.8 V MICROPOWER RAIL-TO-RAIL INPUT/OUTPUT**  
**OPERATIONAL AMPLIFIERS WITH SHUTDOWN**

SLOS326F – JUNE 2000 – REVISED AUGUST 2013

**APPLICATION INFORMATION**

**driving a capacitive load**

When the amplifier is configured in this manner, capacitive loading directly on the output will decrease the device’s phase margin leading to high frequency ringing or oscillations. Therefore, for capacitive loads of greater than 10 pF, it is recommended that a resistor be placed in series ( $R_{NULL}$ ) with the output of the amplifier, as shown in Figure 31. A minimum value of 20  $\Omega$  should work well for most applications.

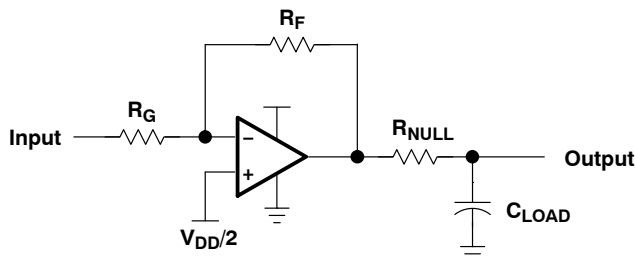

**Figure 31. Driving a Capacitive Load**

**offset voltage**

The output offset voltage, ( $V_{OO}$ ) is the sum of the input offset voltage ( $V_{IO}$ ) and both input bias currents ( $I_{IB}$ ) times the corresponding gains. The following schematic and formula can be used to calculate the output offset voltage:

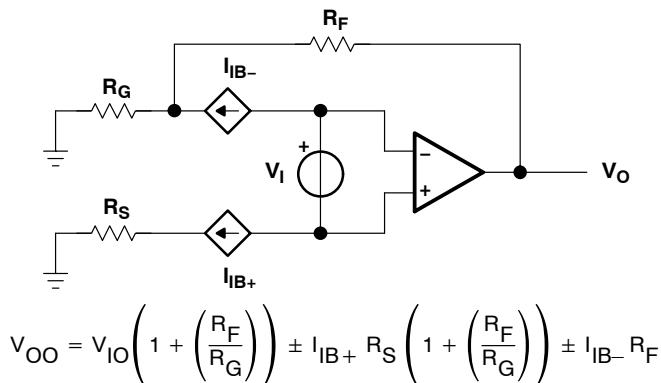

**Figure 32. Output Offset Voltage Model**

**general configurations**

When receiving low-level signals, limiting the bandwidth of the incoming signals into the system is often required. The simplest way to accomplish this is to place an RC filter at the noninverting terminal of the amplifier (see Figure 33).

APPLICATION INFORMATION

general configurations (continued)

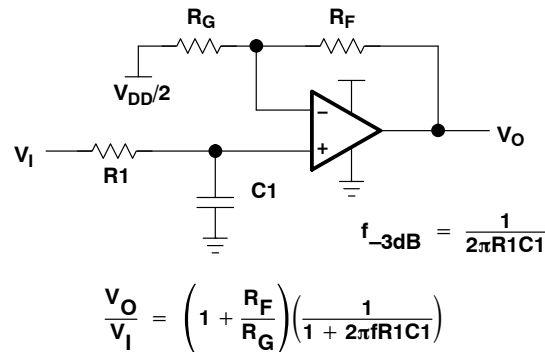

Figure 33. Single-Pole Low-Pass Filter

If even more attenuation is needed, a multiple pole filter is required. The Sallen-Key filter can be used for this task. For best results, the amplifier should have a bandwidth that is 8 to 10 times the filter frequency bandwidth. Failure to do this can result in phase shift of the amplifier.

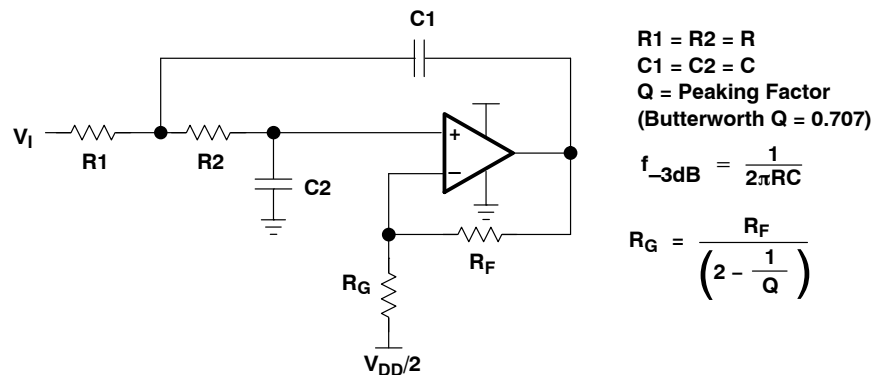

Figure 34. 2-Pole Low-Pass Sallen-Key Filter

circuit layout considerations

To achieve the levels of high performance of the TLV276x, follow proper printed-circuit board design techniques. A general set of guidelines is given in the following.

- Ground planes—It is highly recommended that a ground plane be used on the board to provide all components with a low inductive ground connection. However, in the areas of the amplifier inputs and output, the ground plane can be removed to minimize the stray capacitance.
- Proper power supply decoupling—Use a 6.8-μF tantalum capacitor in parallel with a 0.1-μF ceramic capacitor on each supply terminal. It may be possible to share the tantalum among several amplifiers depending on the application, but a 0.1-μF ceramic capacitor should always be used on the supply terminal of every amplifier. In addition, the 0.1-μF capacitor should be placed as close as possible to the supply terminal. As this distance increases, the inductance in the connecting trace makes the capacitor less effective. The designer should strive for distances of less than 0.1 inches between the device power terminals and the ceramic capacitors.

# TLV2760, TLV2761, TLV2762, TLV2763, TLV2764, TLV2765 FAMILY OF 1.8 V MICROPOWER RAIL-TO-RAIL INPUT/OUTPUT OPERATIONAL AMPLIFIERS WITH SHUTDOWN

SLOS326F – JUNE 2000 – REVISED AUGUST 2013

## APPLICATION INFORMATION

### circuit layout considerations (continued)

- Sockets—Sockets can be used but are not recommended. The additional lead inductance in the socket pins will often lead to stability problems. Surface-mount packages soldered directly to the printed-circuit board is the best implementation.
- Short trace runs/compact part placements—Optimum high performance is achieved when stray series inductance has been minimized. To realize this, the circuit layout should be made as compact as possible, thereby minimizing the length of all trace runs. Particular attention should be paid to the inverting input of the amplifier. Its length should be kept as short as possible. This will help to minimize stray capacitance at the input of the amplifier.
- Surface-mount passive components—Using surface-mount passive components is recommended for high performance amplifier circuits for several reasons. First, because of the extremely low lead inductance of surface-mount components, the problem with stray series inductance is greatly reduced. Second, the small size of surface-mount components naturally leads to a more compact layout thereby minimizing both stray inductance and capacitance. If leaded components are used, it is recommended that the lead lengths be kept as short as possible.

### shutdown function

Three members of the TLV276x family (TLV2760/3/5) have a shutdown terminal for conserving battery life in portable applications. When the shutdown terminal is pulled low, the supply current is reduced to 10 nA/channel, the amplifier is disabled, and the outputs are placed in a high impedance mode. To enable the amplifier, the shutdown terminal must be pulled high. The shutdown terminal should never be left floating. If the shutdown feature is not desired, directly tie the shutdown terminal to the positive rail. The shutdown terminal threshold is always referenced to the GND terminal of the device. Therefore, when operating the device with split supply voltages (e.g.  $\pm 1.8$  V), the shutdown terminal needs to be pulled to the negative rail, not the system ground, to disable the operational amplifier.

The amplifier is powered with a single 2.4-V supply and configured as a noninverting configuration with a unity gain. Turnon and turnoff times are defined as the interval between application of the logic signal to the shutdown pin and the point at which the supply current has reached half its final value. The times for the single, dual, and quad are listed in the data tables.

### general power dissipation considerations

For a given  $\theta_{JA}$ , the maximum power dissipation is shown in Figure 35 and is calculated by the following formula:

$$P_D = \left( \frac{T_{MAX} - T_A}{\theta_{JA}} \right)$$

Where:

- $P_D$  = Maximum power dissipation of TLV276x IC (watts)
- $T_{MAX}$  = Absolute maximum junction temperature (150°C)
- $T_A$  = Free-ambient air temperature (°C)
- $\theta_{JA}$  =  $\theta_{JC} + \theta_{CA}$
- $\theta_{JC}$  = Thermal coefficient from junction to case
- $\theta_{CA}$  = Thermal coefficient from case to ambient air (°C/W)



POST OFFICE BOX 655303 • DALLAS, TEXAS 75265



**TLV2760, TLV2761, TLV2762, TLV2763, TLV2764, TLV2765  
FAMILY OF 1.8 V MICROPOWER RAIL-TO-RAIL INPUT/OUTPUT  
OPERATIONAL AMPLIFIERS WITH SHUTDOWN**

SLOS326F – JUNE 2000 – REVISED AUGUST 2013

**APPLICATION INFORMATION**

**general power dissipation considerations (continued)**

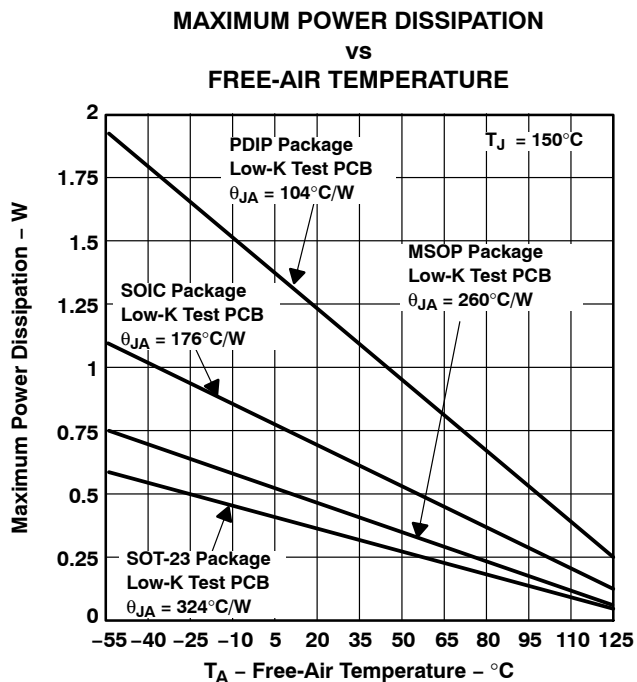

NOTE A: Results are with no air flow and using JEDEC Standard Low-K test PCB.

**Figure 35. Maximum Power Dissipation vs Free-Air Temperature**

# TLV2760, TLV2761, TLV2762, TLV2763, TLV2764, TLV2765 FAMILY OF 1.8 V MICROPOWER RAIL-TO-RAIL INPUT/OUTPUT OPERATIONAL AMPLIFIERS WITH SHUTDOWN

SLOS326F – JUNE 2000 – REVISED AUGUST 2013

## APPLICATION INFORMATION

### macromodel information

Macromodel information provided was derived using Microsim *Parts*™ Release 9.1, the model generation software used with Microsim *PSpice*™. The Boyle macromodel (see Note 4) and subcircuit in Figure 36 are generated using TLV276x typical electrical and operating characteristics at  $T_A = 25^\circ\text{C}$ . Using this information, output simulations of the following key parameters can be generated to a tolerance of 20% (in most cases):

- Maximum positive output voltage swing
- Maximum negative output voltage swing
- Slew rate
- Quiescent power dissipation
- Input bias current
- Open-loop voltage amplification
- Unity-gain frequency
- Common-mode rejection ratio
- Phase margin
- DC output resistance
- AC output resistance
- Short-circuit output current limit

NOTE 4: G. R. Boyle, B. M. Cohn, D. O. Pederson, and J. E. Solomon, "Macromodeling of Integrated Circuit Operational Amplifiers," *IEEE Journal of Solid-State Circuits*, SC-9, 353 (1974).

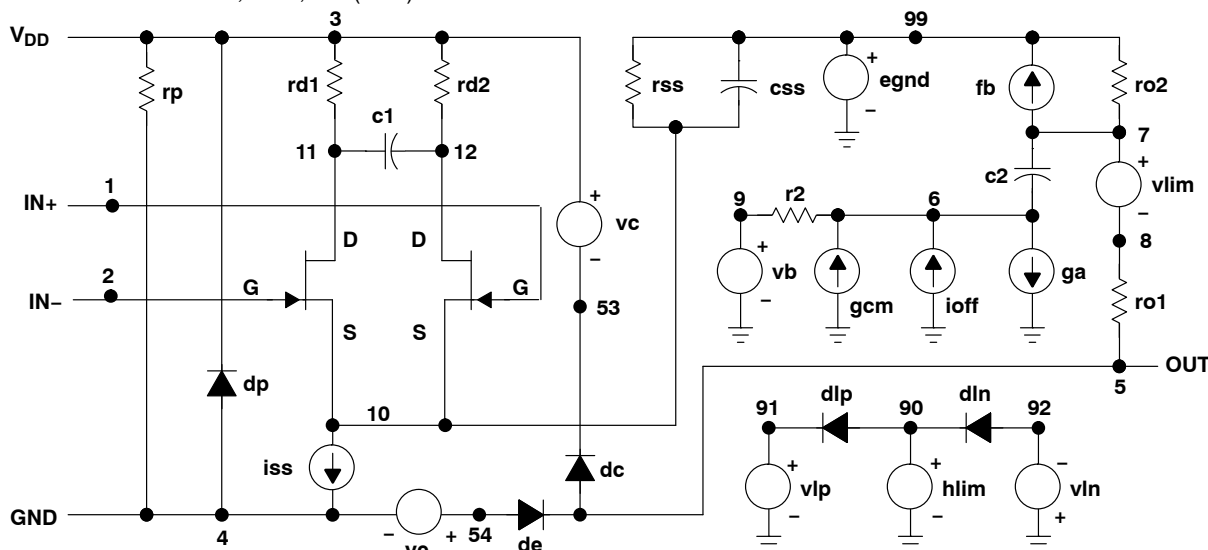

\*DEVICE=amp\_tlv276x\_highVdd,OPAMP,NJF,INT  
\* amp\_tlv\_276x\_highVdd operational amplifier "macromodel"  
\* subcircuit updated using Model Editor release 9.1 on 05/15/00  
\* at 14:40 Model Editor is an OrCAD product.  
\*

\* connections:

non-inverting input  
inverting input  
positive power supply  
negative power supply  
output

.subckt amp\_tlv276x\_highVdd

|      |    |    |   |
|------|----|----|---|
| c1   | 11 | 12 | 457.48E-15  |
| c2   | 6  | 7  | 5.0000E-12  |
| css  | 10 | 99 | 1.1431E-12  |
| dc   | 5  | 53 | dy  |
| de   | 54 | 5  | dy  |
| dip  | 90 | 91 | dx  |
| dln  | 92 | 90 | dx  |
| dp   | 4  | 3  | dx  |
| egnd | 99 | 0  | poly(2) (3,0) (4,0) 0 .5 .5                                     |
| fb   | 7  | 99 | poly(5) vb vc ve vlp vln 0<br>176.02E6 -1E3 1E3 180E6<br>-180E6 |

|        |     |    |  |
|--------|-----|----|--|
| ga     | 6   | 0  | 11 12 16.272E-6                          |
| gcm    | 0   | 6  | 10 99 6.8698E-9                          |
| iss    | 10  | 4  | dc 1.3371E-6                             |
| hlim   | 90  | 0  | vlim 1K                                  |
| j1     | 11  | 2  | 10 jx1                                   |
| J2     | 12  | 1  | 10 jx2                                   |
| r2     | 6   | 9  | 100.00E3                                 |
| rd1    | 3   | 11 | 61.456E3                                 |
| rd2    | 3   | 12 | 61.456E3                                 |
| ro1    | 8   | 5  | 10                                       |
| ro2    | 7   | 99 | 10                                       |
| rp     | 3   | 4  | 150.51E3                                 |
| rss    | 10  | 99 | 149.58E6                                 |
| vb     | 9   | 0  | dc 0                                     |
| vc     | 3   | 53 | dc .78905                                |
| ve     | 54  | 4  | dc .78905                                |
| vlim   | 7   | 8  | dc 0                                     |
| vlp    | 91  | 0  | dc 14.200                                |
| vln    | 0   | 92 | dc 14.200                                |
| .model | dx  |    | D(Is=800.00E-18)                         |
| .model | dy  |    | D(Is=800.00E-18 Rs=1m Cjo=10p)           |
| .model | jx1 |    | NJF(Is=500.00E-15 Beta=198.03E-6 Vto=-1) |
| .model | jx2 |    | NJF(Is=500.00E-15 Beta=198.03E-6 Vto=-1) |
| .ends  |     |    |  |

Figure 36. Boyle Macromodel and Subcircuit

PSpice and Parts are trademarks of MicroSim Corporation.



**Revision History**

| <b>DATE</b> | <b>REV</b> | <b>PAGE</b> | <b>SECTION</b>              | <b>DESCRIPTION</b>                                    |
|-------------|------------|-------------|-----------------------------|---|
| 8/2013      | F          | 2           | 2nd Available Options Table | Added TLVZ762CDGK and AJO to Available Options Table. |

NOTE: Page numbers for previous revisions may differ from page numbers in the current version.

DRAFT ONLY

**PACKAGING INFORMATION**

| Orderable Device | Status<br>(1) | Package Type | Package Drawing | Pins | Package Qty | Eco Plan<br>(2) | Lead finish/<br>Ball material<br>(6) | MSL Peak Temp<br>(3) | Op Temp (°C) | Device Marking<br>(4/5) | Samples                 |
|------------------|---------------|--------------|-----------------|------|-------------|-----------------|--------------------------------------|----------------------|--------------|-------------------------|-------------------------|
| TLV2760ID        | ACTIVE        | SOIC         | D               | 8    | 75          | RoHS & Green    | NIPDAU                               | Level-1-260C-UNLIM   | -40 to 85    | T2760I                  | <a href="#">Samples</a> |
| TLV2760IDBVR     | ACTIVE        | SOT-23       | DBV             | 6    | 3000        | RoHS & Green    | NIPDAU                               | Level-1-260C-UNLIM   | -40 to 85    | VANI                    | <a href="#">Samples</a> |
| TLV2760IP        | ACTIVE        | PDIP         | P               | 8    | 50          | RoHS & Green    | NIPDAU                               | N / A for Pkg Type   | -40 to 85    | T2760I                  | <a href="#">Samples</a> |
| TLV2761CD        | ACTIVE        | SOIC         | D               | 8    | 75          | RoHS & Green    | NIPDAU                               | Level-1-260C-UNLIM   | 0 to 70      | T2761C                  | <a href="#">Samples</a> |
| TLV2761ID        | ACTIVE        | SOIC         | D               | 8    | 75          | RoHS & Green    | NIPDAU                               | Level-1-260C-UNLIM   | -40 to 85    | T2761I                  | <a href="#">Samples</a> |
| TLV2761IDBVR     | ACTIVE        | SOT-23       | DBV             | 5    | 3000        | RoHS & Green    | NIPDAU                               | Level-1-260C-UNLIM   | -40 to 85    | VAXI                    | <a href="#">Samples</a> |
| TLV2761IP        | ACTIVE        | PDIP         | P               | 8    | 50          | RoHS & Green    | NIPDAU                               | N / A for Pkg Type   | -40 to 85    | T2761I                  | <a href="#">Samples</a> |
| TLV2762CDGKR     | ACTIVE        | VSSOP        | DGK             | 8    | 2500        | RoHS & Green    | NIPDAUAG                             | Level-1-260C-UNLIM   | 0 to 70      | AJO                     | <a href="#">Samples</a> |
| TLV2762CDR       | ACTIVE        | SOIC         | D               | 8    | 2500        | RoHS & Green    | NIPDAU                               | Level-1-260C-UNLIM   | 0 to 70      | 2762C                   | <a href="#">Samples</a> |
| TLV2762IDGKR     | ACTIVE        | VSSOP        | DGK             | 8    | 2500        | RoHS & Green    | NIPDAU                               | Level-1-260C-UNLIM   | -40 to 85    | AJP                     | <a href="#">Samples</a> |
| TLV2762IDR       | ACTIVE        | SOIC         | D               | 8    | 2500        | RoHS & Green    | NIPDAU                               | Level-1-260C-UNLIM   | -40 to 85    | 2762I                   | <a href="#">Samples</a> |
| TLV2763IDGS      | ACTIVE        | VSSOP        | DGS             | 10   | 80          | RoHS & Green    | NIPDAU   NIPDAUAG                    | Level-1-260C-UNLIM   | -40 to 85    | AJR                     | <a href="#">Samples</a> |
| TLV2763IDGSR     | ACTIVE        | VSSOP        | DGS             | 10   | 2500        | RoHS & Green    | NIPDAU   NIPDAUAG                    | Level-1-260C-UNLIM   | -40 to 85    | AJR                     | <a href="#">Samples</a> |
| TLV2764IDR       | ACTIVE        | SOIC         | D               | 14   | 2500        | RoHS & Green    | NIPDAU                               | Level-1-260C-UNLIM   | -40 to 85    | TLV2764I                | <a href="#">Samples</a> |
| TLV2764IN        | ACTIVE        | PDIP         | N               | 14   | 25          | RoHS & Green    | NIPDAU                               | N / A for Pkg Type   | -40 to 85    | TLV2764I                | <a href="#">Samples</a> |
| TLV2764IPWR      | ACTIVE        | TSSOP        | PW              | 14   | 2000        | RoHS & Green    | NIPDAU                               | Level-1-260C-UNLIM   | -40 to 85    | 2764I                   | <a href="#">Samples</a> |
| TLV2764IPWRG4    | ACTIVE        | TSSOP        | PW              | 14   | 2000        | TBD             | Call TI                              | Call TI              | -40 to 85    |                         | <a href="#">Samples</a> |
| TLV2765CDR       | ACTIVE        | SOIC         | D               | 16   | 2500        | RoHS & Green    | NIPDAU                               | Level-1-260C-UNLIM   | 0 to 70      | TLV2765C                | <a href="#">Samples</a> |
| TLV2765IPW       | ACTIVE        | TSSOP        | PW              | 16   | 90          | RoHS & Green    | NIPDAU                               | Level-1-260C-UNLIM   | -40 to 85    | 2765I                   | <a href="#">Samples</a> |
| TLV2765IPWR      | ACTIVE        | TSSOP        | PW              | 16   | 2000        | RoHS & Green    | NIPDAU                               | Level-1-260C-UNLIM   | -40 to 85    | 2765I                   | <a href="#">Samples</a> |

(1) The marketing status values are defined as follows:

**ACTIVE:** Product device recommended for new designs.

**LIFEBUY:** TI has announced that the device will be discontinued, and a lifetime-buy period is in effect.

**NRND:** Not recommended for new designs. Device is in production to support existing customers, but TI does not recommend using this part in a new design.

**PREVIEW:** Device has been announced but is not in production. Samples may or may not be available.

**OBSOLETE:** TI has discontinued the production of the device.

(2) **RoHS:** TI defines "RoHS" to mean semiconductor products that are compliant with the current EU RoHS requirements for all 10 RoHS substances, including the requirement that RoHS substance do not exceed 0.1% by weight in homogeneous materials. Where designed to be soldered at high temperatures, "RoHS" products are suitable for use in specified lead-free processes. TI may reference these types of products as "Pb-Free".

**RoHS Exempt:** TI defines "RoHS Exempt" to mean products that contain lead but are compliant with EU RoHS pursuant to a specific EU RoHS exemption.

**Green:** TI defines "Green" to mean the content of Chlorine (Cl) and Bromine (Br) based flame retardants meet JS709B low halogen requirements of  $\leq 1000$ ppm threshold. Antimony trioxide based flame retardants must also meet the  $\leq 1000$ ppm threshold requirement.

(3) MSL, Peak Temp. - The Moisture Sensitivity Level rating according to the JEDEC industry standard classifications, and peak solder temperature.

(4) There may be additional marking, which relates to the logo, the lot trace code information, or the environmental category on the device.

(5) Multiple Device Markings will be inside parentheses. Only one Device Marking contained in parentheses and separated by a "~" will appear on a device. If a line is indented then it is a continuation of the previous line and the two combined represent the entire Device Marking for that device.

(6) Lead finish/Ball material - Orderable Devices may have multiple material finish options. Finish options are separated by a vertical ruled line. Lead finish/Ball material values may wrap to two lines if the finish value exceeds the maximum column width.

**Important Information and Disclaimer:** The information provided on this page represents TI's knowledge and belief as of the date that it is provided. TI bases its knowledge and belief on information provided by third parties, and makes no representation or warranty as to the accuracy of such information. Efforts are underway to better integrate information from third parties. TI has taken and continues to take reasonable steps to provide representative and accurate information but may not have conducted destructive testing or chemical analysis on incoming materials and chemicals. TI and TI suppliers consider certain information to be proprietary, and thus CAS numbers and other limited information may not be available for release.

In no event shall TI's liability arising out of such information exceed the total purchase price of the TI part(s) at issue in this document sold by TI to Customer on an annual basis.

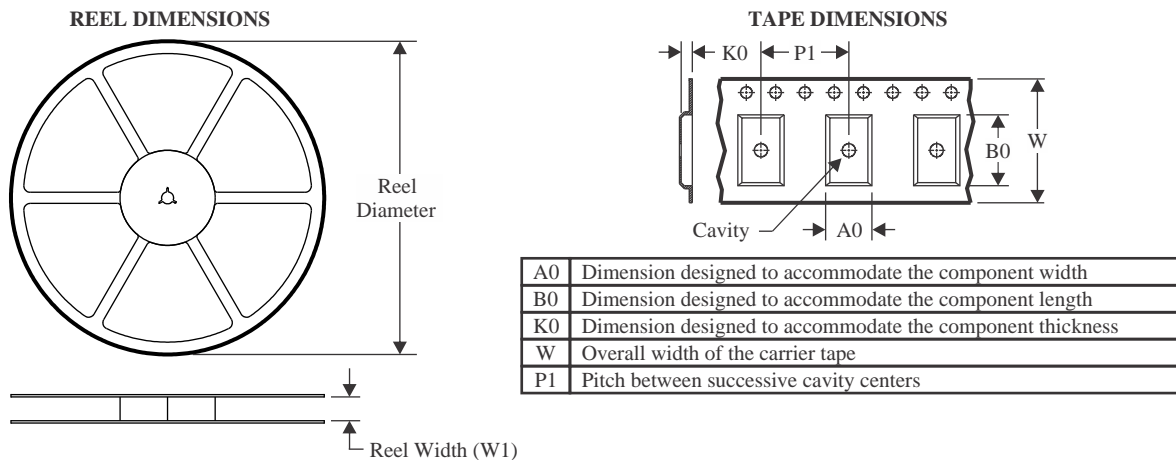
**TAPE AND REEL INFORMATION**

**QUADRANT ASSIGNMENTS FOR PIN 1 ORIENTATION IN TAPE**

\*All dimensions are nominal

| Device       | Package Type | Package Drawing | Pins | SPQ  | Reel Diameter (mm) | Reel Width W1 (mm) | A0 (mm) | B0 (mm) | K0 (mm) | P1 (mm) | W (mm) | Pin1 Quadrant |
|--------------|--------------|-----------------|------|------|--------------------|--------------------|---------|---------|---------|---------|--------|---------------|
| TLV2760IDBVR | SOT-23       | DBV             | 6    | 3000 | 180.0              | 9.0                | 3.15    | 3.2     | 1.4     | 4.0     | 8.0    | Q3            |
| TLV2761IDBVR | SOT-23       | DBV             | 5    | 3000 | 180.0              | 9.0                | 3.15    | 3.2     | 1.4     | 4.0     | 8.0    | Q3            |
| TLV2762CDGKR | VSSOP        | DGK             | 8    | 2500 | 330.0              | 12.4               | 5.3     | 3.4     | 1.4     | 8.0     | 12.0   | Q1            |
| TLV2762CDR   | SOIC         | D               | 8    | 2500 | 330.0              | 12.4               | 6.4     | 5.2     | 2.1     | 8.0     | 12.0   | Q1            |
| TLV2762IDGKR | VSSOP        | DGK             | 8    | 2500 | 330.0              | 12.4               | 5.3     | 3.4     | 1.4     | 8.0     | 12.0   | Q1            |
| TLV2762IDR   | SOIC         | D               | 8    | 2500 | 330.0              | 12.4               | 6.4     | 5.2     | 2.1     | 8.0     | 12.0   | Q1            |
| TLV2763IDGSR | VSSOP        | DGS             | 10   | 2500 | 330.0              | 12.4               | 5.3     | 3.4     | 1.4     | 8.0     | 12.0   | Q1            |
| TLV2763IDGSR | VSSOP        | DGS             | 10   | 2500 | 330.0              | 12.4               | 5.3     | 3.4     | 1.4     | 8.0     | 12.0   | Q1            |
| TLV2764IDR   | SOIC         | D               | 14   | 2500 | 330.0              | 16.4               | 6.5     | 9.0     | 2.1     | 8.0     | 16.0   | Q1            |
| TLV2764IPWR  | TSSOP        | PW              | 14   | 2000 | 330.0              | 12.4               | 6.9     | 5.6     | 1.6     | 8.0     | 12.0   | Q1            |
| TLV2765CDR   | SOIC         | D               | 16   | 2500 | 330.0              | 16.4               | 6.5     | 10.3    | 2.1     | 8.0     | 16.0   | Q1            |
| TLV2765IPWR  | TSSOP        | PW              | 16   | 2000 | 330.0              | 12.4               | 6.9     | 5.6     | 1.6     | 8.0     | 12.0   | Q1            |

**TAPE AND REEL BOX DIMENSIONS**

\*All dimensions are nominal

| Device       | Package Type | Package Drawing | Pins | SPQ  | Length (mm) | Width (mm) | Height (mm) |
|--------------|--------------|-----------------|------|------|-------------|------------|-------------|
| TLV2760IDBVR | SOT-23       | DBV             | 6    | 3000 | 182.0       | 182.0      | 20.0        |
| TLV2761IDBVR | SOT-23       | DBV             | 5    | 3000 | 182.0       | 182.0      | 20.0        |
| TLV2762CDGKR | VSSOP        | DGK             | 8    | 2500 | 364.0       | 364.0      | 27.0        |
| TLV2762CDR   | SOIC         | D               | 8    | 2500 | 340.5       | 338.1      | 20.6        |
| TLV2762IDGKR | VSSOP        | DGK             | 8    | 2500 | 358.0       | 335.0      | 35.0        |
| TLV2762IDR   | SOIC         | D               | 8    | 2500 | 340.5       | 338.1      | 20.6        |
| TLV2763IDGSR | VSSOP        | DGS             | 10   | 2500 | 358.0       | 335.0      | 35.0        |
| TLV2763IDGSR | VSSOP        | DGS             | 10   | 2500 | 364.0       | 364.0      | 27.0        |
| TLV2764IDR   | SOIC         | D               | 14   | 2500 | 333.2       | 345.9      | 28.6        |
| TLV2764IPWR  | TSSOP        | PW              | 14   | 2000 | 356.0       | 356.0      | 35.0        |
| TLV2765CDR   | SOIC         | D               | 16   | 2500 | 340.5       | 336.1      | 32.0        |
| TLV2765IPWR  | TSSOP        | PW              | 16   | 2000 | 356.0       | 356.0      | 35.0        |

**TUBE**

\*All dimensions are nominal

| Device      | Package Name | Package Type | Pins | SPQ | L (mm) | W (mm) | T (μm) | B (mm) |
|-------------|--------------|--------------|------|-----|--------|--------|--------|--------|
| TLV2760ID   | D            | SOIC         | 8    | 75  | 507    | 8      | 3940   | 4.32   |
| TLV2760IP   | P            | PDIP         | 8    | 50  | 506    | 13.97  | 11230  | 4.32   |
| TLV2761CD   | D            | SOIC         | 8    | 75  | 507    | 8      | 3940   | 4.32   |
| TLV2761ID   | D            | SOIC         | 8    | 75  | 507    | 8      | 3940   | 4.32   |
| TLV2761IP   | P            | PDIP         | 8    | 50  | 506    | 13.97  | 11230  | 4.32   |
| TLV2763IDGS | DGS          | VSSOP        | 10   | 80  | 330    | 6.55   | 500    | 2.88   |
| TLV2764IN   | N            | PDIP         | 14   | 25  | 506    | 13.97  | 11230  | 4.32   |
| TLV2765IPW  | PW           | TSSOP        | 16   | 90  | 530    | 10.2   | 3600   | 3.5    |





# EXAMPLE BOARD LAYOUT

DBV0006A

SOT-23 - 1.45 mm max height

SMALL OUTLINE TRANSISTOR

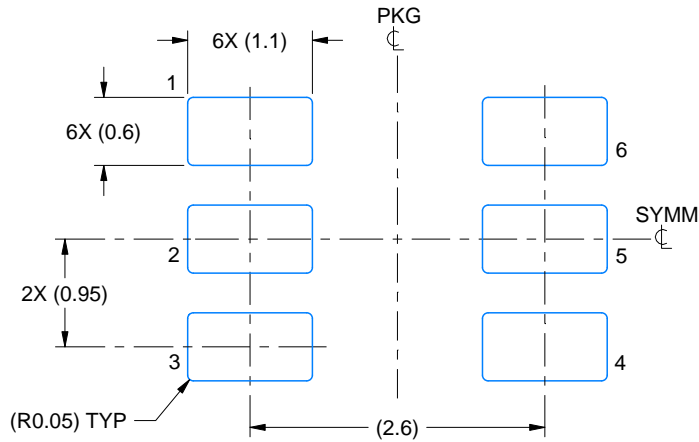

LAND PATTERN EXAMPLE  
EXPOSED METAL SHOWN  
SCALE:15X

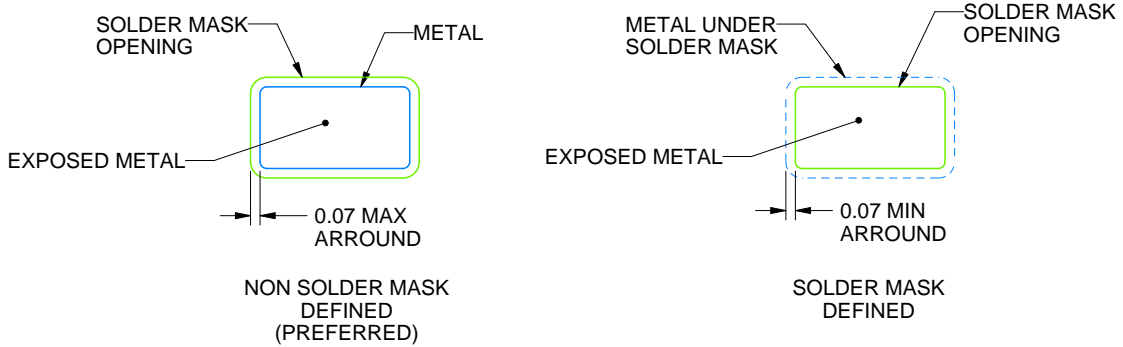

SOLDER MASK DETAILS

4214840/E 02/2024

NOTES: (continued)

- 6. Publication IPC-7351 may have alternate designs.
- 7. Solder mask tolerances between and around signal pads can vary based on board fabrication site.

# EXAMPLE STENCIL DESIGN

DBV0006A

SOT-23 - 1.45 mm max height

SMALL OUTLINE TRANSISTOR

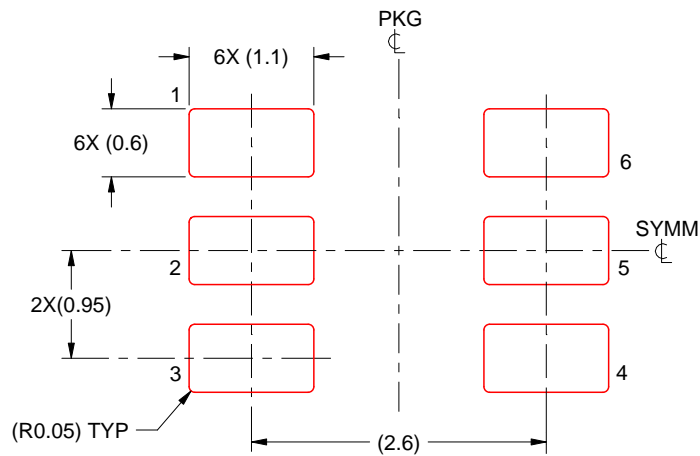

SOLDER PASTE EXAMPLE  
BASED ON 0.125 mm THICK STENCIL  
SCALE:15X

4214840/E 02/2024

NOTES: (continued)

8. Laser cutting apertures with trapezoidal walls and rounded corners may offer better paste release. IPC-7525 may have alternate design recommendations.
9. Board assembly site may have different recommendations for stencil design.

# DGS0010A



# PACKAGE OUTLINE

## VSSOP - 1.1 mm max height

SMALL OUTLINE PACKAGE



4221984/A 05/2015

### NOTES:

1. All linear dimensions are in millimeters. Any dimensions in parenthesis are for reference only. Dimensioning and tolerancing per ASME Y14.5M.
2. This drawing is subject to change without notice.
3. This dimension does not include mold flash, protrusions, or gate burrs. Mold flash, protrusions, or gate burrs shall not exceed 0.15 mm per side.
4. This dimension does not include interlead flash. Interlead flash shall not exceed 0.25 mm per side.
5. Reference JEDEC registration MO-187, variation BA.

# EXAMPLE BOARD LAYOUT

DGS0010A

VSSOP - 1.1 mm max height

SMALL OUTLINE PACKAGE



LAND PATTERN EXAMPLE  
SCALE:10X



SOLDER MASK DETAILS  
NOT TO SCALE

4221984/A 05/2015

NOTES: (continued)

- 6. Publication IPC-7351 may have alternate designs.
- 7. Solder mask tolerances between and around signal pads can vary based on board fabrication site.

# EXAMPLE STENCIL DESIGN

DGS0010A

VSSOP - 1.1 mm max height

SMALL OUTLINE PACKAGE



SOLDER PASTE EXAMPLE  
BASED ON 0.125 mm THICK STENCIL  
SCALE:10X

4221984/A 05/2015

NOTES: (continued)

8. Laser cutting apertures with trapezoidal walls and rounded corners may offer better paste release. IPC-7525 may have alternate design recommendations.
9. Board assembly site may have different recommendations for stencil design.

# DBV0005A



# PACKAGE OUTLINE

SOT-23 - 1.45 mm max height

SMALL OUTLINE TRANSISTOR



**NOTES:**

1. All linear dimensions are in millimeters. Any dimensions in parenthesis are for reference only. Dimensioning and tolerancing per ASME Y14.5M.
2. This drawing is subject to change without notice.
3. Reference JEDEC MO-178.
4. Body dimensions do not include mold flash, protrusions, or gate burrs. Mold flash, protrusions, or gate burrs shall not exceed 0.25 mm per side.
5. Support pin may differ or may not be present.

# EXAMPLE BOARD LAYOUT

DBV0005A

SOT-23 - 1.45 mm max height

SMALL OUTLINE TRANSISTOR



LAND PATTERN EXAMPLE  
EXPOSED METAL SHOWN  
SCALE:15X

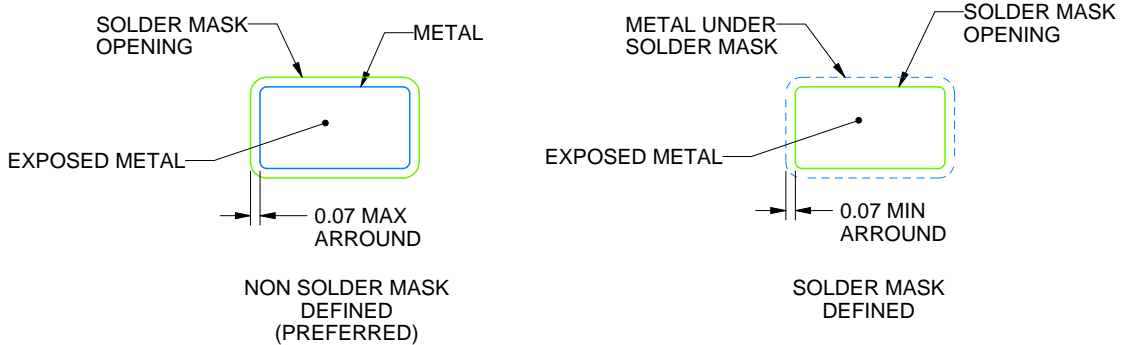

SOLDER MASK DETAILS

4214839/J 02/2024

NOTES: (continued)

- 6. Publication IPC-7351 may have alternate designs.
- 7. Solder mask tolerances between and around signal pads can vary based on board fabrication site.



# EXAMPLE STENCIL DESIGN

DBV0005A

SOT-23 - 1.45 mm max height

SMALL OUTLINE TRANSISTOR



SOLDER PASTE EXAMPLE  
BASED ON 0.125 mm THICK STENCIL  
SCALE:15X

4214839/J 02/2024

NOTES: (continued)

8. Laser cutting apertures with trapezoidal walls and rounded corners may offer better paste release. IPC-7525 may have alternate design recommendations.
9. Board assembly site may have different recommendations for stencil design.

D (R-PDSO-G14)

PLASTIC SMALL OUTLINE



- NOTES:
- A. All linear dimensions are in inches (millimeters).
  - B. This drawing is subject to change without notice.
  - $\triangle C$  Body length does not include mold flash, protrusions, or gate burrs. Mold flash, protrusions, or gate burrs shall not exceed 0.006 (0,15) each side.
  - $\triangle D$  Body width does not include interlead flash. Interlead flash shall not exceed 0.017 (0,43) each side.
  - E. Reference JEDEC MS-012 variation AB.

D (R-PDSO-G14)

PLASTIC SMALL OUTLINE



- NOTES:
- All linear dimensions are in millimeters.
  - This drawing is subject to change without notice.
  - Publication IPC-7351 is recommended for alternate designs.
  - Laser cutting apertures with trapezoidal walls and also rounding corners will offer better paste release. Customers should contact their board assembly site for stencil design recommendations. Refer to IPC-7525 for other stencil recommendations.
  - Customers should contact their board fabrication site for solder mask tolerances between and around signal pads.

PW (R-PDSO-G14)

PLASTIC SMALL OUTLINE



- NOTES:
- A. All linear dimensions are in millimeters. Dimensioning and tolerancing per ASME Y14.5M-1994.
  - B. This drawing is subject to change without notice.
  - C. Body length does not include mold flash, protrusions, or gate burrs. Mold flash, protrusions, or gate burrs shall not exceed 0,15 each side.
  - D. Body width does not include interlead flash. Interlead flash shall not exceed 0,25 each side.
  - E. Falls within JEDEC MO-153



D0008A

# PACKAGE OUTLINE

SOIC - 1.75 mm max height

SMALL OUTLINE INTEGRATED CIRCUIT



4214825/C 02/2019

NOTES:

- Linear dimensions are in inches [millimeters]. Dimensions in parenthesis are for reference only. Controlling dimensions are in inches. Dimensioning and tolerancing per ASME Y14.5M.
- This drawing is subject to change without notice.
- This dimension does not include mold flash, protrusions, or gate burrs. Mold flash, protrusions, or gate burrs shall not exceed  $.006$  [0.15] per side.
- This dimension does not include interlead flash.
- Reference JEDEC registration MS-012, variation AA.

# EXAMPLE BOARD LAYOUT

D0008A

SOIC - 1.75 mm max height

SMALL OUTLINE INTEGRATED CIRCUIT



LAND PATTERN EXAMPLE  
 EXPOSED METAL SHOWN  
 SCALE:8X



SOLDER MASK DETAILS

4214825/C 02/2019

NOTES: (continued)

- 6. Publication IPC-7351 may have alternate designs.
- 7. Solder mask tolerances between and around signal pads can vary based on board fabrication site.

# EXAMPLE STENCIL DESIGN

D0008A

SOIC - 1.75 mm max height

SMALL OUTLINE INTEGRATED CIRCUIT



SOLDER PASTE EXAMPLE  
BASED ON .005 INCH [0.125 MM] THICK STENCIL  
SCALE:8X

4214825/C 02/2019

NOTES: (continued)

8. Laser cutting apertures with trapezoidal walls and rounded corners may offer better paste release. IPC-7525 may have alternate design recommendations.
9. Board assembly site may have different recommendations for stencil design.

P (R-PDIP-T8)

PLASTIC DUAL-IN-LINE PACKAGE



- NOTES:
- A. All linear dimensions are in inches (millimeters).
  - B. This drawing is subject to change without notice.
  - C. Falls within JEDEC MS-001 variation BA.



N (R-PDIP-T\*\*)

PLASTIC DUAL-IN-LINE PACKAGE

16 PINS SHOWN



- NOTES:
- A. All linear dimensions are in inches (millimeters).
  - B. This drawing is subject to change without notice.
  - Falls within JEDEC MS-001, except 18 and 20 pin minimum body length (Dim A).
  - The 20 pin end lead shoulder width is a vendor option, either half or full width.

# DGK0008A



## PACKAGE OUTLINE

### VSSOP - 1.1 mm max height

SMALL OUTLINE PACKAGE



4214862/A 04/2023

#### NOTES:

PowerPAD is a trademark of Texas Instruments.

1. All linear dimensions are in millimeters. Any dimensions in parenthesis are for reference only. Dimensioning and tolerancing per ASME Y14.5M.
2. This drawing is subject to change without notice.
3. This dimension does not include mold flash, protrusions, or gate burrs. Mold flash, protrusions, or gate burrs shall not exceed 0.15 mm per side.
4. This dimension does not include interlead flash. Interlead flash shall not exceed 0.25 mm per side.
5. Reference JEDEC registration MO-187.

# EXAMPLE BOARD LAYOUT

DGK0008A

™ VSSOP - 1.1 mm max height

SMALL OUTLINE PACKAGE



LAND PATTERN EXAMPLE  
EXPOSED METAL SHOWN  
SCALE: 15X

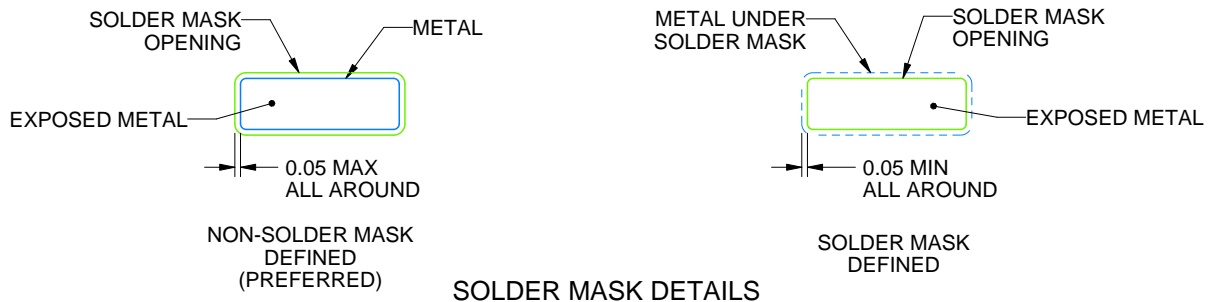

SOLDER MASK DETAILS

4214862/A 04/2023

NOTES: (continued)

6. Publication IPC-7351 may have alternate designs.
7. Solder mask tolerances between and around signal pads can vary based on board fabrication site.
8. Vias are optional depending on application, refer to device data sheet. If any vias are implemented, refer to their locations shown on this view. It is recommended that vias under paste be filled, plugged or tented.
9. Size of metal pad may vary due to creepage requirement.

# EXAMPLE STENCIL DESIGN

DGK0008A

<sup>TM</sup> VSSOP - 1.1 mm max height

SMALL OUTLINE PACKAGE



SOLDER PASTE EXAMPLE  
SCALE: 15X

4214862/A 04/2023

NOTES: (continued)

11. Laser cutting apertures with trapezoidal walls and rounded corners may offer better paste release. IPC-7525 may have alternate design recommendations.
12. Board assembly site may have different recommendations for stencil design.

D (R-PDSO-G16)

PLASTIC SMALL OUTLINE



- NOTES:
- A. All linear dimensions are in inches (millimeters).
  - B. This drawing is subject to change without notice.
  - C. Body length does not include mold flash, protrusions, or gate burrs. Mold flash, protrusions, or gate burrs shall not exceed 0.006 (0,15) each side.
  - D. Body width does not include interlead flash. Interlead flash shall not exceed 0.017 (0,43) each side.
  - E. Reference JEDEC MS-012 variation AC.



4220204/A 02/2017

NOTES:

1. All linear dimensions are in millimeters. Any dimensions in parenthesis are for reference only. Dimensioning and tolerancing per ASME Y14.5M.
2. This drawing is subject to change without notice.
3. This dimension does not include mold flash, protrusions, or gate burrs. Mold flash, protrusions, or gate burrs shall not exceed 0.15 mm per side.
4. This dimension does not include interlead flash. Interlead flash shall not exceed 0.25 mm per side.
5. Reference JEDEC registration MO-153.

# EXAMPLE BOARD LAYOUT

PW0016A

TSSOP - 1.2 mm max height

SMALL OUTLINE PACKAGE



LAND PATTERN EXAMPLE  
EXPOSED METAL SHOWN  
SCALE: 10X



4220204/A 02/2017

NOTES: (continued)

- 6. Publication IPC-7351 may have alternate designs.
- 7. Solder mask tolerances between and around signal pads can vary based on board fabrication site.

# EXAMPLE STENCIL DESIGN

PW0016A

TSSOP - 1.2 mm max height

SMALL OUTLINE PACKAGE



SOLDER PASTE EXAMPLE  
BASED ON 0.125 mm THICK STENCIL  
SCALE: 10X

4220204/A 02/2017

NOTES: (continued)

8. Laser cutting apertures with trapezoidal walls and rounded corners may offer better paste release. IPC-7525 may have alternate design recommendations.
9. Board assembly site may have different recommendations for stencil design.



## IMPORTANT NOTICE AND DISCLAIMER

TI PROVIDES TECHNICAL AND RELIABILITY DATA (INCLUDING DATA SHEETS), DESIGN RESOURCES (INCLUDING REFERENCE DESIGNS), APPLICATION OR OTHER DESIGN ADVICE, WEB TOOLS, SAFETY INFORMATION, AND OTHER RESOURCES "AS IS" AND WITH ALL FAULTS, AND DISCLAIMS ALL WARRANTIES, EXPRESS AND IMPLIED, INCLUDING WITHOUT LIMITATION ANY IMPLIED WARRANTIES OF MERCHANTABILITY, FITNESS FOR A PARTICULAR PURPOSE OR NON-INFRINGEMENT OF THIRD PARTY INTELLECTUAL PROPERTY RIGHTS.

These resources are intended for skilled developers designing with TI products. You are solely responsible for (1) selecting the appropriate TI products for your application, (2) designing, validating and testing your application, and (3) ensuring your application meets applicable standards, and any other safety, security, regulatory or other requirements.

These resources are subject to change without notice. TI grants you permission to use these resources only for development of an application that uses the TI products described in the resource. Other reproduction and display of these resources is prohibited. No license is granted to any other TI intellectual property right or to any third party intellectual property right. TI disclaims responsibility for, and you will fully indemnify TI and its representatives against, any claims, damages, costs, losses, and liabilities arising out of your use of these resources.

TI's products are provided subject to [TI's Terms of Sale](#) or other applicable terms available either on [ti.com](https://www.ti.com) or provided in conjunction with such TI products. TI's provision of these resources does not expand or otherwise alter TI's applicable warranties or warranty disclaimers for TI products.

TI objects to and rejects any additional or different terms you may have proposed.

Mailing Address: Texas Instruments, Post Office Box 655303, Dallas, Texas 75265  
Copyright © 2024, Texas Instruments Incorporated