

# PolarHT™ Power MOSFET

**IXTQ 64N25P**  
**IXTT 64N25P**

$V_{DSS} = 250 \text{ V}$   
 $I_{D25} = 64 \text{ A}$   
 $R_{DS(on)} \leq 49 \text{ m}\Omega$

N-Channel Enhancement Mode  
Avalanche Rated



| Symbol     | Test Conditions   | Maximum Ratings |                  |
|------------|---|-----------------|------------------|
| $V_{DSS}$  | $T_J = 25^\circ\text{C to } 150^\circ\text{C}$  | 250             | V                |
| $V_{DGR}$  | $T_J = 25^\circ\text{C to } 150^\circ\text{C}; R_{GS} = 1 \text{ M}\Omega$  | 250             | V                |
| $V_{GSS}$  | Continuous  | $\pm 20$        | V                |
| $V_{GSM}$  | Transient   | $\pm 30$        | V                |
| $I_{D25}$  | $T_C = 25^\circ\text{C}$  | 64              | A                |
| $I_{DM}$   | $T_C = 25^\circ\text{C}$ , pulse width limited by $T_{JM}$  | 160             | A                |
| $I_{AR}$   | $T_C = 25^\circ\text{C}$  | 60              | A                |
| $E_{AR}$   | $T_C = 25^\circ\text{C}$  | 40              | mJ               |
| $E_{AS}$   | $T_C = 25^\circ\text{C}$  | 1.0             | J                |
| $dv/dt$    | $I_S \leq I_{DM}$ , $di/dt \leq 100 \text{ A}/\mu\text{s}$ , $V_{DD} \leq V_{DSS}$ ,<br>$T_J \leq 150^\circ\text{C}$ , $R_G = 4 \Omega$ | 10              | V/ns             |
| $P_D$      | $T_C = 25^\circ\text{C}$  | 400             | W                |
| $T_J$      |   | -55 ... +150    | $^\circ\text{C}$ |
| $T_{JM}$   |   | 150             | $^\circ\text{C}$ |
| $T_{stg}$  |   | -55 ... +150    | $^\circ\text{C}$ |
| $T_L$      | 1.6 mm (0.062 in.) from case for 10 s   | 300             | $^\circ\text{C}$ |
| $T_{SOLD}$ | Plastic body for 10 s   | 260             | $^\circ\text{C}$ |
| $M_d$      | Mounting torque (TO-3P)   | 1.13/10         | Nm/lb.in.        |
| Weight     | TO-3P   | 5.5             | g                |
|            | TO-268  | 5.0             | g                |

TO-3P (IXTQ)

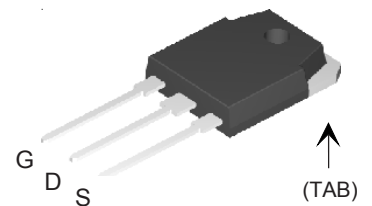

TO-268 (IXTT)



G = Gate      D = Drain  
S = Source      TAB = Drain

### Features

- † International standard packages
- † Unclamped Inductive Switching (UIS) rated
- † Low package inductance  
- easy to drive and to protect

### Advantages

- † Easy to mount
- † Space savings
- † High power density

| Symbol       | Test Conditions<br>( $T_J = 25^\circ\text{C}$ , unless otherwise specified)                                     | Characteristic Values |      |                      |
|--------------|---|-----------------------|------|----------------------|
|              |   | Min.                  | Typ. | Max.                 |
| $BV_{DSS}$   | $V_{GS} = 0 \text{ V}$ , $I_D = 250 \mu\text{A}$  | 250                   |      | V                    |
| $V_{GS(th)}$ | $V_{DS} = V_{GS}$ , $I_D = 250 \mu\text{A}$   | 2.5                   |      | 5.0 V                |
| $I_{GSS}$    | $V_{GS} = \pm 20 \text{ V}_{DC}$ , $V_{DS} = 0$   |                       |      | $\pm 100 \text{ nA}$ |
| $I_{DSS}$    | $V_{DS} = V_{DSS}$<br>$V_{GS} = 0 \text{ V}$<br>$T_J = 125^\circ\text{C}$                                       |                       |      | 25 $\mu\text{A}$     |
|              |   |                       |      | 250 $\mu\text{A}$    |
| $R_{DS(on)}$ | $V_{GS} = 10 \text{ V}$ , $I_D = 0.5 I_{D25}$<br>Pulse test, $t \leq 300 \mu\text{s}$ , duty cycle $d \leq 2\%$ |                       |      | 49 $\text{m}\Omega$  |

| Symbol                    | Test Conditions   | Characteristic Values                               |      |          |
|---------------------------|---|---|------|----------|
|                           |   | (T <sub>J</sub> = 25°C, unless otherwise specified) |      |          |
|                           |   | Min.  | Typ. | Max.     |
| <b>g<sub>fs</sub></b>     | V <sub>DS</sub> = 10 V; I <sub>D</sub> = 0.5 I <sub>D25</sub> , pulse test  | 20  | 30   | S        |
| <b>C<sub>iss</sub></b>    | V <sub>GS</sub> = 0 V, V <sub>DS</sub> = 25 V, f = 1 MHz  |   | 3450 | pF       |
| <b>C<sub>oss</sub></b>    |   | 640   | pF   |          |
| <b>C<sub>rss</sub></b>    |   | 155   | pF   |          |
| <b>t<sub>d(on)</sub></b>  | V <sub>GS</sub> = 10 V, V <sub>DS</sub> = 0.5 V <sub>DSS</sub> , I <sub>D</sub> = I <sub>D25</sub><br>R <sub>G</sub> = 4 Ω (External) |   | 21   | ns       |
| <b>t<sub>r</sub></b>      |   | 23  | ns   |          |
| <b>t<sub>d(off)</sub></b> |   | 60  | ns   |          |
| <b>t<sub>f</sub></b>      |   | 20  | ns   |          |
| <b>Q<sub>g(on)</sub></b>  | V <sub>GS</sub> = 10 V, V <sub>DS</sub> = 0.5 V <sub>DSS</sub> , I <sub>D</sub> = 0.5 I <sub>D25</sub>                                |   | 105  | nC       |
| <b>Q<sub>gs</sub></b>     |   | 24  | nC   |          |
| <b>Q<sub>gd</sub></b>     |   | 53  | nC   |          |
| <b>R<sub>thJC</sub></b>   | (TO-3P)   |   |      | 0.31°C/W |
| <b>R<sub>thCS</sub></b>   |   | 0.21  | °C/W |          |

| Symbol                | Test Conditions  | Characteristic Values                               |      |       |
|-----------------------|--|---|------|-------|
|                       |  | (T <sub>J</sub> = 25°C, unless otherwise specified) |      |       |
|                       |  | Min.  | Typ. | Max.  |
| <b>I<sub>S</sub></b>  | V <sub>GS</sub> = 0 V  |   |      | 64 A  |
| <b>I<sub>SM</sub></b> | Repetitive   |   |      | 160 A |
| <b>V<sub>SD</sub></b> | I <sub>F</sub> = I <sub>S</sub> , V <sub>GS</sub> = 0 V,<br>Pulse test, t ≤ 300 μs, duty cycle d ≤ 2 % |   |      | 1.5 V |
| <b>t<sub>rr</sub></b> | I <sub>F</sub> = 25 A, -di/dt = 100 A/μs<br>V <sub>R</sub> = 100 V, V <sub>GS</sub> = 0 V              |   | 200  | ns    |
| <b>Q<sub>RM</sub></b> |  | 3.0   | μC   |       |

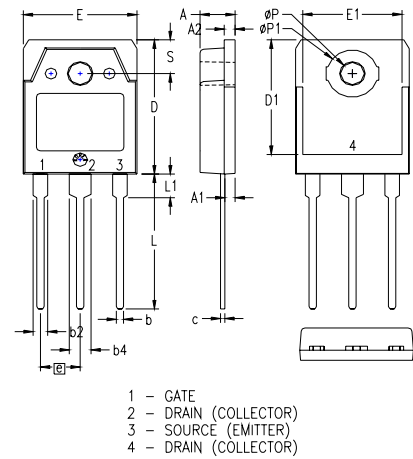
**TO-3P (IXTQ) Outline**

| SYM | INCHES   |      | MILLIMETERS |       |
|-----|----------|------|-------------|-------|
|     | MIN      | MAX  | MIN         | MAX   |
| A   | .185     | .193 | 4.70        | 4.90  |
| A1  | .051     | .059 | 1.30        | 1.50  |
| A2  | .057     | .065 | 1.45        | 1.65  |
| b   | .035     | .045 | 0.90        | 1.15  |
| b2  | .075     | .087 | 1.90        | 2.20  |
| b4  | .114     | .126 | 2.90        | 3.20  |
| c   | .022     | .031 | 0.55        | 0.80  |
| D   | .780     | .791 | 19.80       | 20.10 |
| D1  | .665     | .677 | 16.90       | 17.20 |
| E   | .610     | .622 | 15.50       | 15.80 |
| E1  | .531     | .539 | 13.50       | 13.70 |
| e   | .215 BSC |      | 5.45 BSC    |       |
| L   | .779     | .795 | 19.80       | 20.20 |
| L1  | .134     | .142 | 3.40        | 3.60  |
| øP  | .126     | .134 | 3.20        | 3.40  |
| øP1 | .272     | .280 | 6.90        | 7.10  |
| S   | .193     | .201 | 4.90        | 5.10  |

All metal area are tin plated.

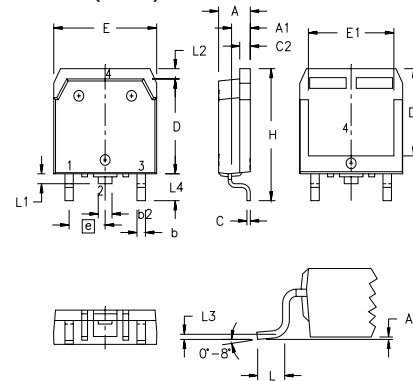
**TO-268 (IXTT) Outline**

| SYM | INCHES   |      | MILLIMETERS |       |
|-----|----------|------|-------------|-------|
|     | MIN      | MAX  | MIN         | MAX   |
| A   | .193     | .201 | 4.90        | 5.10  |
| A1  | .106     | .114 | 2.70        | 2.90  |
| A2  | .001     | .010 | 0.02        | 0.25  |
| b   | .045     | .057 | 1.15        | 1.45  |
| b2  | .075     | .083 | 1.90        | 2.10  |
| C   | .016     | .026 | 0.40        | 0.65  |
| C2  | .057     | .063 | 1.45        | 1.60  |
| D   | .543     | .551 | 13.80       | 14.00 |
| D1  | .488     | .500 | 12.40       | 12.70 |
| E   | .624     | .632 | 15.85       | 16.05 |
| E1  | .524     | .535 | 13.30       | 13.60 |
| e   | .215 BSC |      | 5.45 BSC    |       |
| H   | .736     | .752 | 18.70       | 19.10 |
| L   | .094     | .106 | 2.40        | 2.70  |
| L1  | .047     | .055 | 1.20        | 1.40  |
| L2  | .039     | .045 | 1.00        | 1.15  |
| L3  | .010 BSC |      | 0.25 BSC    |       |
| L4  | .150     | .161 | 3.80        | 4.10  |

IXYS reserves the right to change limits, test conditions, and dimensions.

|  |           |           |           |           |              |              |             |              |
|--|-----------|-----------|-----------|-----------|--------------|--------------|-------------|--------------|
| IXYS MOSFETs and IGBTs are covered by      | 4,835,592 | 4,931,844 | 5,049,961 | 5,237,481 | 6,162,665    | 6,404,065 B1 | 6,683,344   | 6,727,585    |
| one or more of the following U.S. patents: | 4,850,072 | 5,017,508 | 5,063,307 | 5,381,025 | 6,259,123 B1 | 6,534,343    | 6,710,405B2 | 6,759,692    |
|  | 4,881,106 | 5,034,796 | 5,187,117 | 5,486,715 | 6,306,728 B1 | 6,583,505    | 6,710,463   | 6,771,478 B2 |

**Fig. 1. Output Characteristics @ 25°C**

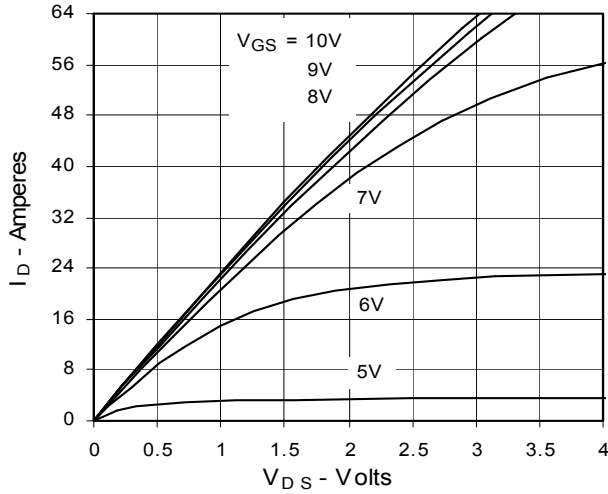

**Fig. 2. Extended Output Characteristics @ 25°C**

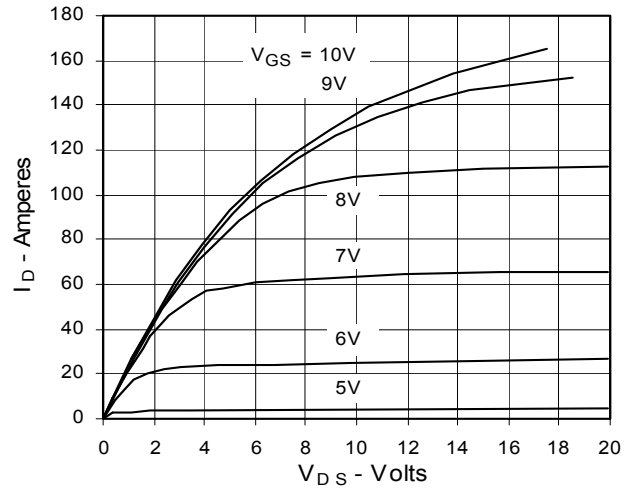

**Fig. 3. Output Characteristics @ 125°C**

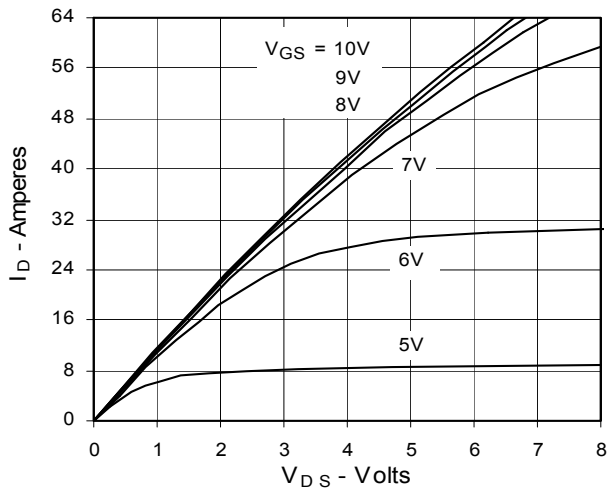

**Fig. 4.  $R_{DS(on)}$  Normalized to 0.5  $I_{D25}$  Value vs. Junction Temperature**

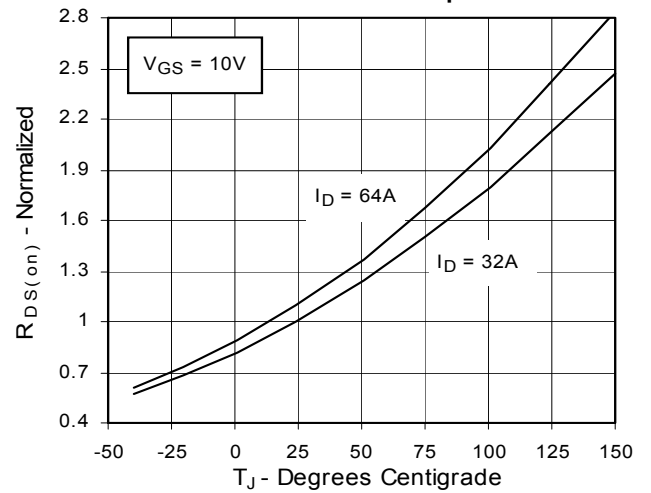

**Fig. 5.  $R_{DS(on)}$  Normalized to 0.5  $I_{D25}$  Value vs.  $I_D$**

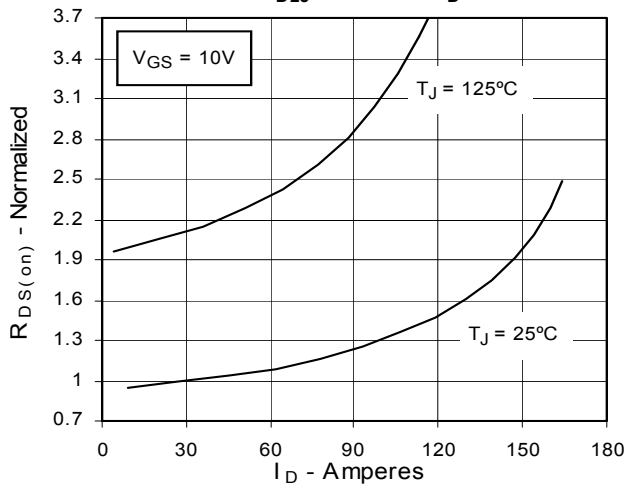

**Fig. 6. Drain Current vs. Case Temperature**

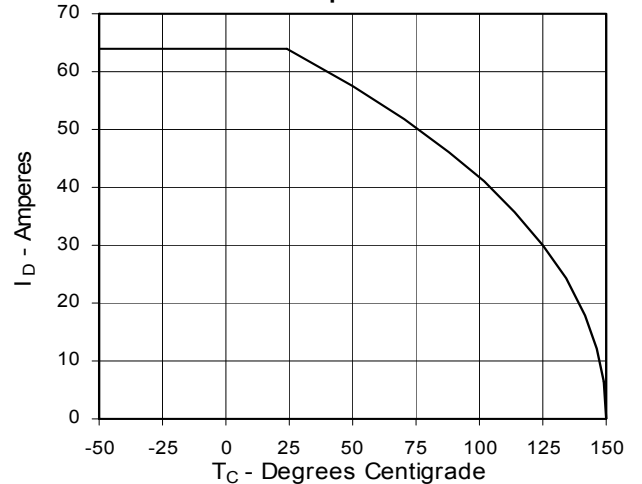

**Fig. 7. Input Admittance**

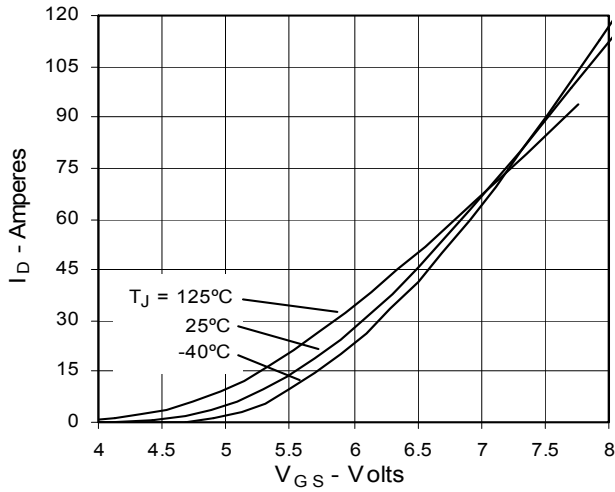

**Fig. 8. Transconductance**

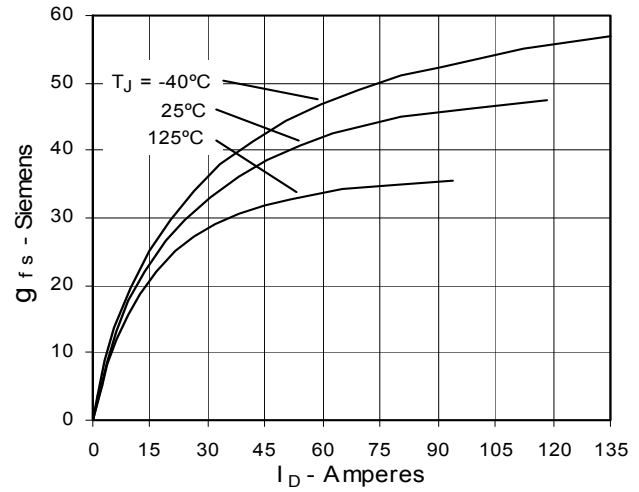

**Fig. 9. Source Current vs. Source-To-Drain Voltage**

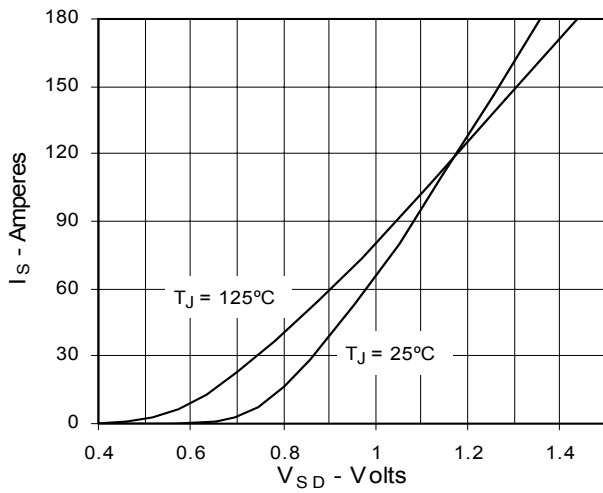

**Fig. 10. Gate Charge**

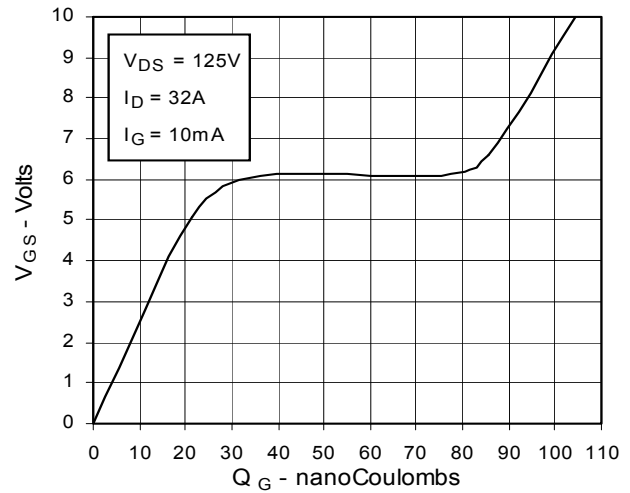

**Fig. 11. Capacitance**

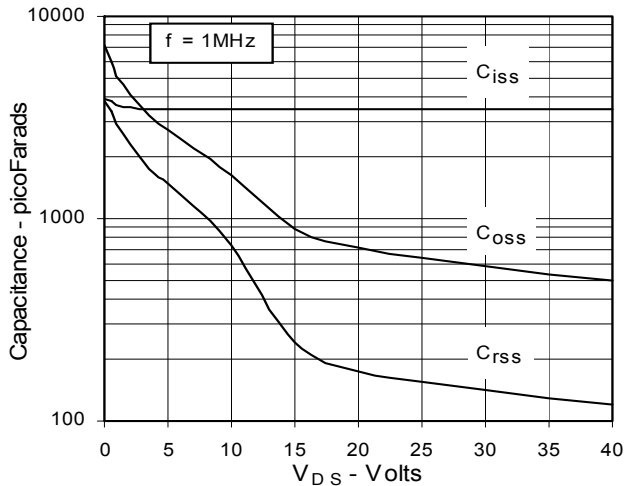

**Fig. 12. Forward-Bias Safe Operating Area**

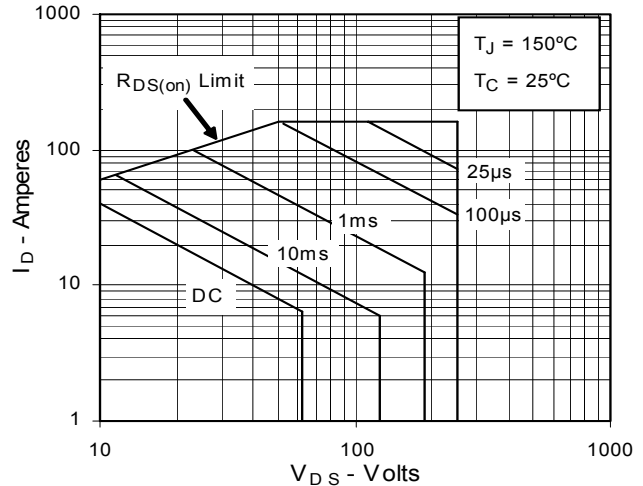
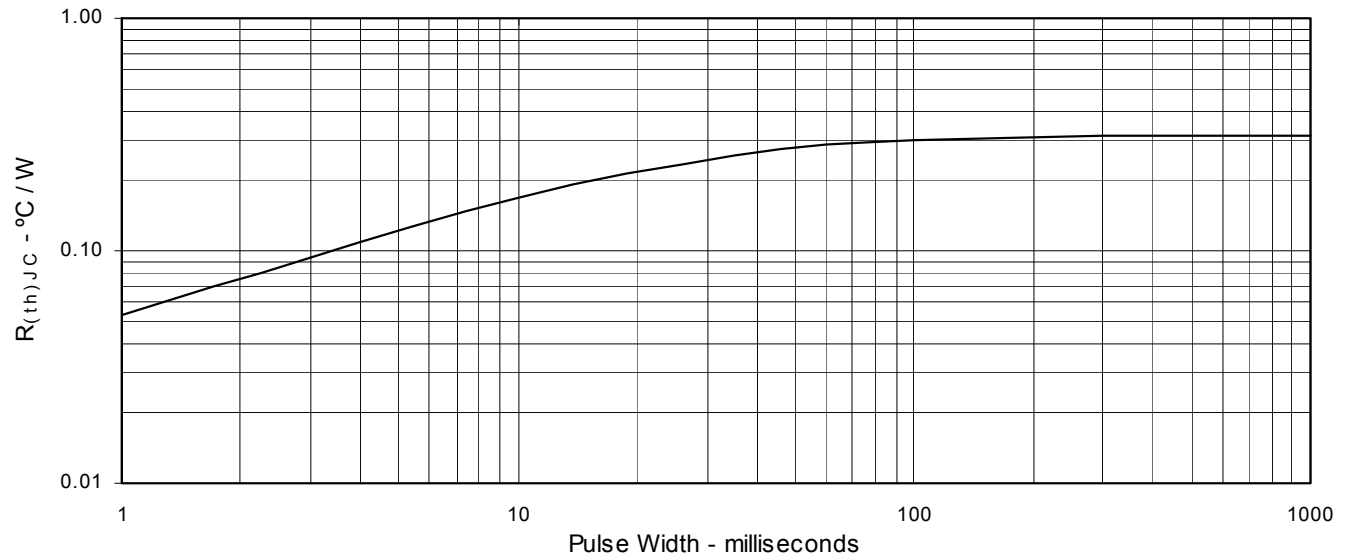

Fig. 13. Maximum Transient Thermal Resistance



# Mouser Electronics

Authorized Distributor

Click to View Pricing, Inventory, Delivery & Lifecycle Information:

[IXYS:](#)

[IXTQ64N25P](#) [IXTT64N25P](#)