

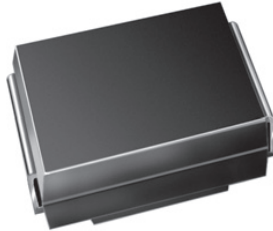

Surface Mount TRANSZORB® Transient Voltage Suppressors



SMB (DO-214AA)



RoHS
COMPLIANT
HALOGEN
FREE
Available

FEATURES

- Low profile package
- Ideal for automated placement
- Glass passivated chip junction
- Available in uni-directional and bi-directional
- 600 W peak pulse power capability with a 10/1000 μ s waveform, repetitive rate (duty cycle): 0.01 %
- Excellent clamping capability
- Very fast response time
- Low incremental surge resistance
- Meets MSL level 1, per J-STD-020, LF maximum peak of 260 °C
- AEC-Q101 qualified available
- Automotive ordering code: base P/NHE3 or P/NHM3
- Material categorization: for definitions of compliance please see www.vishay.com/doc?99912

TYPICAL APPLICATIONS

Use in sensitive electronics protection against voltage transients induced by inductive load switching and lighting on ICs, MOSFET, signal lines of sensor units for consumer, computer, industrial, and telecommunication.

MECHANICAL DATA

Case: SMB (DO-214AA)
Molding compound meets UL 94 V-0 flammability rating
Base P/N-E3 - RoHS-compliant, commercial grade
Base P/N-M3 - halogen-free, RoHS-compliant, commercial grade
Base P/NHE3_X - RoHS-compliant and AEC-Q101 qualified
Base P/NHM3_X - halogen-free, RoHS-compliant, and AEC-Q101 qualified
("X" denotes revision code e.g. A, B, ...)

Terminals: matte tin plated leads, solderable per J-STD-002 and JESD 22-B102
E3, M3, HE3, and HM3 suffix meets JESD 201 class 2 whisker test

Polarity: for uni-directional types the band denotes cathode end, no marking on bi-directional types

| PRIMARY CHARACTERISTICS | |
|---|---------------------------------|
| V _{BR} (bi-directional) | 6.4 V to 231 V |
| V _{BR} (uni-directional) | 6.4 V to 231 V |
| V _{WM} | 5.0 V to 188 V |
| P _{PPM} | 600 W |
| I _{FSM} (uni-directional only) | 100 A |
| T _J max. | 150 °C |
| Polarity | Uni-directional, bi-directional |
| Package | SMB (DO-214AA) |

DEVICES FOR BI-DIRECTION APPLICATIONS

For bi-directional devices use CA suffix (e.g. SMBJ10CA).
Electrical characteristics apply in both directions.

| MAXIMUM RATINGS (T _A = 25 °C unless otherwise noted) | | | |
|---|-----------------------------------|----------------|------|
| PARAMETER | SYMBOL | VALUE | UNIT |
| Peak pulse power dissipation with a 10/1000 μ s waveform ⁽¹⁾⁽²⁾ (fig. 1) | P _{PPM} | 600 | W |
| Peak pulse current with a 10/1000 μ s waveform ⁽¹⁾ | I _{PPM} | See next table | A |
| Peak forward surge current 8.3 ms single half sine-wave uni-directional only ⁽²⁾ | I _{FSM} | 100 | A |
| Operating junction and storage temperature range | T _J , T _{STG} | -55 to +150 | °C |

Notes

- ⁽¹⁾ Non-repetitive current pulse, per fig. 3 and derated above T_A = 25 °C per fig. 2
- ⁽²⁾ Mounted on 0.2" x 0.2" (5.0 mm x 5.0 mm) copper pads to each terminal



| ELECTRICAL CHARACTERISTICS (T _A = 25 °C unless otherwise noted) | | | | | | | | | |
|--|---------------------|----|--|------|----------------------------------|---------------------------------------|---|--|---|
| DEVICE TYPE MODIFIED "J" BEND LEAD | DEVICE MARKING CODE | | BREAKDOWN VOLTAGE V _{BR} AT I _T ⁽¹⁾ (V) | | TEST CURRENT I _T (mA) | STAND-OFF VOLTAGE V _{WM} (V) | MAXIMUM REVERSE LEAKAGE AT V _{WM} I _D (μA) ⁽³⁾ | MAXIMUM PEAK PULSE SURGE CURRENT I _{PPM} (A) ⁽²⁾ | MAXIMUM CLAMPING VOLTAGE AT I _{PPM} V _C (V) |
| | UNI | BI | MIN. | MAX. | | | | | |
| (+)SMBJ5.0A ⁽⁵⁾ | KE | KE | 6.40 | 7.07 | 10 | 5.0 | 800 | 65.2 | 9.2 |
| (+)SMBJ6.0A | KG | KG | 6.67 | 7.37 | 10 | 6.0 | 800 | 58.3 | 10.3 |
| (+)SMBJ6.5A | KK | AK | 7.22 | 7.98 | 10 | 6.5 | 500 | 53.6 | 11.2 |
| (+)SMBJ7.0A | KM | KM | 7.78 | 8.60 | 10 | 7.0 | 200 | 50.0 | 12.0 |
| (+)SMBJ7.5A | KP | AP | 8.33 | 9.21 | 1.0 | 7.5 | 100 | 46.5 | 12.9 |
| (+)SMBJ8.0A | KR | AR | 8.89 | 9.83 | 1.0 | 8.0 | 50 | 44.1 | 13.6 |
| (+)SMBJ8.5A | KT | AT | 9.44 | 10.4 | 1.0 | 8.5 | 20 | 41.7 | 14.4 |
| (+)SMBJ9.0A | KV | AV | 10.0 | 11.1 | 1.0 | 9.0 | 10 | 39.0 | 15.4 |
| (+)SMBJ10A | KX | AX | 11.1 | 12.3 | 1.0 | 10 | 5.0 | 35.3 | 17.0 |
| (+)SMBJ11A | KZ | KZ | 12.2 | 13.5 | 1.0 | 11 | 5.0 | 33.0 | 18.2 |
| (+)SMBJ12A | LE | BE | 13.3 | 14.7 | 1.0 | 12 | 5.0 | 30.2 | 19.9 |
| (+)SMBJ13A | LG | LG | 14.4 | 15.9 | 1.0 | 13 | 1.0 | 27.9 | 21.5 |
| (+)SMBJ14A | LK | BK | 15.6 | 17.2 | 1.0 | 14 | 1.0 | 25.9 | 23.2 |
| (+)SMBJ15A | LM | BM | 16.7 | 18.5 | 1.0 | 15 | 1.0 | 24.6 | 24.4 |
| (+)SMBJ16A | LP | LM | 17.8 | 19.7 | 1.0 | 16 | 1.0 | 23.1 | 26.0 |
| (+)SMBJ17A | LR | LR | 18.9 | 20.9 | 1.0 | 17 | 1.0 | 21.7 | 27.6 |
| (+)SMBJ18A | LT | BT | 20.0 | 22.1 | 1.0 | 18 | 1.0 | 20.5 | 29.2 |
| (+)SMBJ20A | LV | LV | 22.2 | 24.5 | 1.0 | 20 | 1.0 | 18.5 | 32.4 |
| (+)SMBJ22A | LX | BX | 24.4 | 26.9 | 1.0 | 22 | 1.0 | 16.9 | 35.5 |
| (+)SMBJ24A | LZ | BZ | 26.7 | 29.5 | 1.0 | 24 | 1.0 | 15.4 | 38.9 |
| (+)SMBJ26A | ME | CE | 28.9 | 31.9 | 1.0 | 26 | 1.0 | 14.3 | 42.1 |
| (+)SMBJ28A | MG | MG | 31.1 | 34.4 | 1.0 | 28 | 1.0 | 13.2 | 45.4 |
| (+)SMBJ30A | MK | CK | 33.3 | 36.8 | 1.0 | 30 | 1.0 | 12.4 | 48.4 |
| (+)SMBJ33A | MM | CM | 36.7 | 40.6 | 1.0 | 33 | 1.0 | 11.3 | 53.3 |
| (+)SMBJ36A | MP | CP | 40.0 | 44.2 | 1.0 | 36 | 1.0 | 10.3 | 58.1 |
| (+)SMBJ40A | MR | CR | 44.4 | 49.1 | 1.0 | 40 | 1.0 | 9.3 | 64.5 |
| (+)SMBJ43A | MT | CT | 47.8 | 52.8 | 1.0 | 43 | 1.0 | 8.6 | 69.4 |
| (+)SMBJ45A | MV | MV | 50.0 | 55.3 | 1.0 | 45 | 1.0 | 8.3 | 72.7 |
| (+)SMBJ48A | MX | MX | 53.3 | 58.9 | 1.0 | 48 | 1.0 | 7.8 | 77.4 |
| (+)SMBJ51A | MZ | MZ | 56.7 | 62.7 | 1.0 | 51 | 1.0 | 7.3 | 82.4 |
| (+)SMBJ54A | NE | NE | 60.0 | 66.3 | 1.0 | 54 | 1.0 | 6.9 | 87.1 |
| (+)SMBJ58A | NG | NG | 64.4 | 71.2 | 1.0 | 58 | 1.0 | 6.4 | 93.6 |
| (+)SMBJ60A | NK | NK | 66.7 | 73.7 | 1.0 | 60 | 1.0 | 6.2 | 96.8 |
| (+)SMBJ64A | NM | NM | 71.1 | 78.6 | 1.0 | 64 | 1.0 | 5.8 | 103 |
| (+)SMBJ70A | NP | NP | 77.8 | 86.0 | 1.0 | 70 | 1.0 | 5.3 | 113 |
| (+)SMBJ75A | NR | NR | 83.3 | 92.1 | 1.0 | 75 | 1.0 | 5.0 | 121 |
| (+)SMBJ78A | NT | NT | 86.7 | 95.8 | 1.0 | 78 | 1.0 | 4.8 | 126 |
| (+)SMBJ85A | NV | NV | 94.4 | 104 | 1.0 | 85 | 1.0 | 4.4 | 137 |
| (+)SMBJ90A | NX | NX | 100 | 111 | 1.0 | 90 | 1.0 | 4.1 | 146 |
| (+)SMBJ100A | NZ | NZ | 111 | 123 | 1.0 | 100 | 1.0 | 3.7 | 162 |
| (+)SMBJ110A | PE | PE | 122 | 135 | 1.0 | 110 | 1.0 | 3.4 | 177 |
| (+)SMBJ120A | PG | PG | 133 | 147 | 1.0 | 120 | 1.0 | 3.1 | 193 |
| (+)SMBJ130A | PK | PK | 144 | 159 | 1.0 | 130 | 1.0 | 2.9 | 209 |
| (+)SMBJ150A | PM | PM | 167 | 185 | 1.0 | 150 | 1.0 | 2.5 | 243 |
| (+)SMBJ160A | PP | PP | 178 | 197 | 1.0 | 160 | 1.0 | 2.3 | 259 |
| (+)SMBJ170A | PR | PR | 189 | 209 | 1.0 | 170 | 1.0 | 2.2 | 275 |
| SMBJ188A | PS | PS | 209 | 231 | 1.0 | 188 | 1.0 | 2.0 | 328 |

Notes

- (1) Pulse test: t_p ≤ 50 ms
- (2) Surge current waveform per fig. 3 and derate per fig. 2
- (3) For bi-directional types having V_{WM} of 10 V and less, the I_D limit is doubled
- (4) All terms and symbols are consistent with ANSI/IEEE C62.35
- (5) For the bi-directional SMBJ5.0CA, the maximum V_{BR} is 7.25 V
- (6) V_F = 3.5 V max. at I_F = 50 A (uni-directional only)
- (+) Underwriters laboratory recognition for the classification of protectors (QVGQ2) under the UL standard for safety 497B and file number E136766 for both uni-directional and bi-directional devices



| THERMAL CHARACTERISTICS (T _A = 25 °C unless otherwise noted) | | | |
|---|------------------|-------|-------|
| PARAMETER | SYMBOL | VALUE | UNIT |
| Typical thermal resistance, junction to ambient ⁽¹⁾ | R _{θJA} | 100 | °C/ W |
| Typical thermal resistance, junction to lead | R _{θJL} | 20 | |

Note

⁽¹⁾ Mounted on minimum recommended pad layout

| ORDERING INFORMATION (Example) | | | | |
|--------------------------------|-----------------|------------------------|---------------|------------------------------------|
| PREFERRED P/N | UNIT WEIGHT (g) | PREFERRED PACKAGE CODE | BASE QUANTITY | DELIVERY MODE |
| SMBJ5.0A-E3/52 | 0.096 | 52 | 750 | 7" diameter plastic tape and reel |
| SMBJ5.0A-M3/52 | | | | |
| SMBJ5.0A-E3/5B | 0.096 | 5B | 3200 | 13" diameter plastic tape and reel |
| SMBJ5.0A-M3/5B | | | | |
| SMBJ5.0AHE3_A/H ⁽¹⁾ | 0.096 | H | 750 | 7" diameter plastic tape and reel |
| SMBJ5.0AHM3_A/H ⁽¹⁾ | | | | |
| SMBJ5.0AHE3_A/I ⁽¹⁾ | 0.096 | I | 3200 | 13" diameter plastic tape and reel |
| SMBJ5.0AHM3_A/I ⁽¹⁾ | | | | |

Note

⁽¹⁾ AEC-Q101 qualified

RATINGS AND CHARACTERISTICS CURVES (T_A = 25 °C unless otherwise noted)

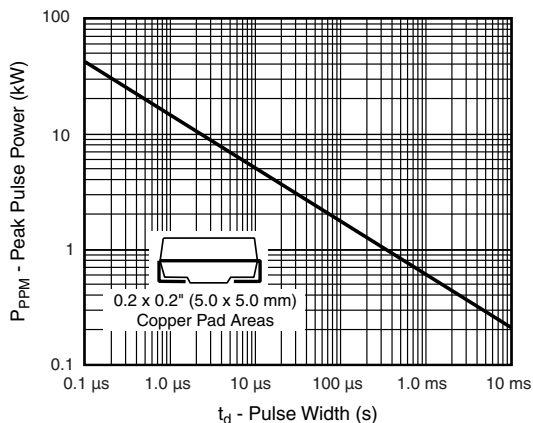

Fig. 1 - Peak Pulse Power Rating Curve

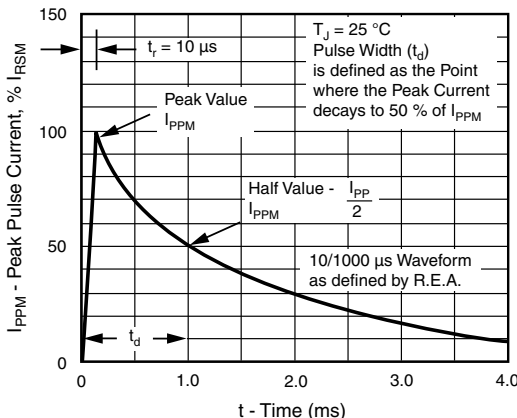

Fig. 3 - Pulse Waveform

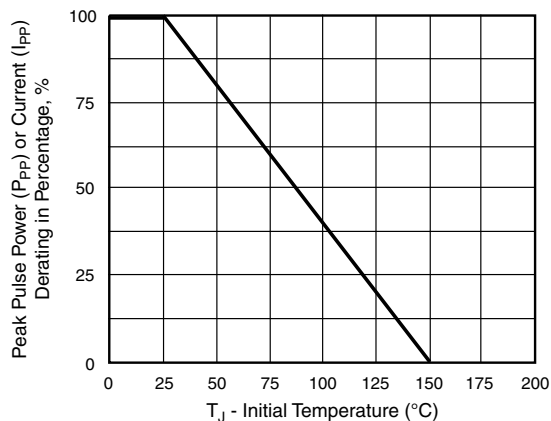

Fig. 2 - Pulse Power or Current vs. Initial Junction Temperature

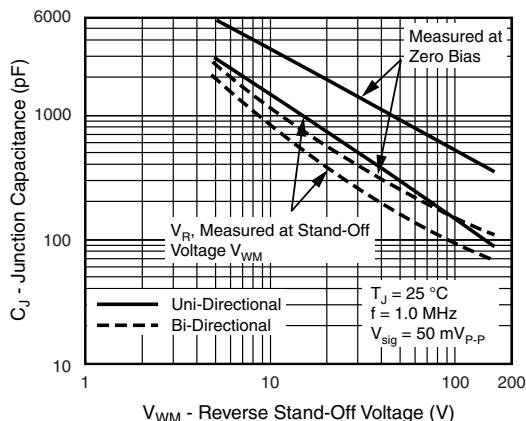

Fig. 4 - Typical Junction Capacitance

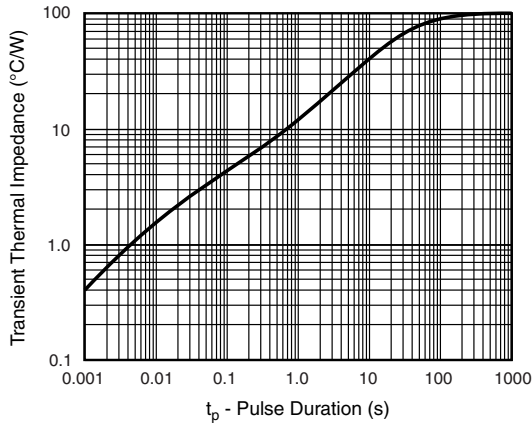

Fig. 5 - Typical Transient Thermal Impedance

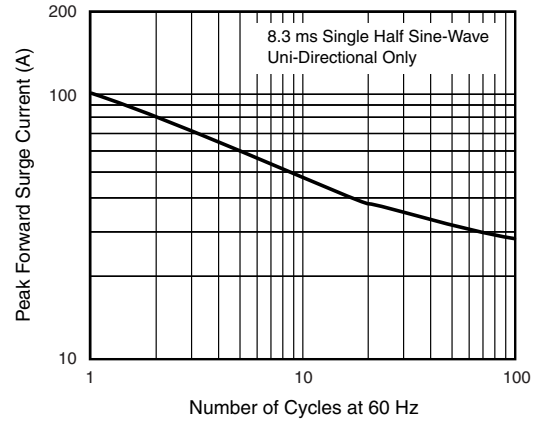
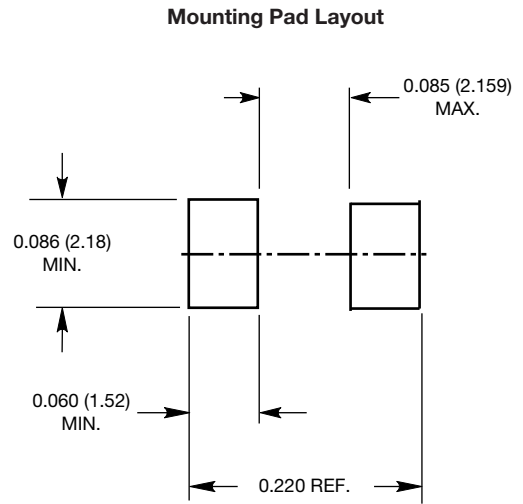
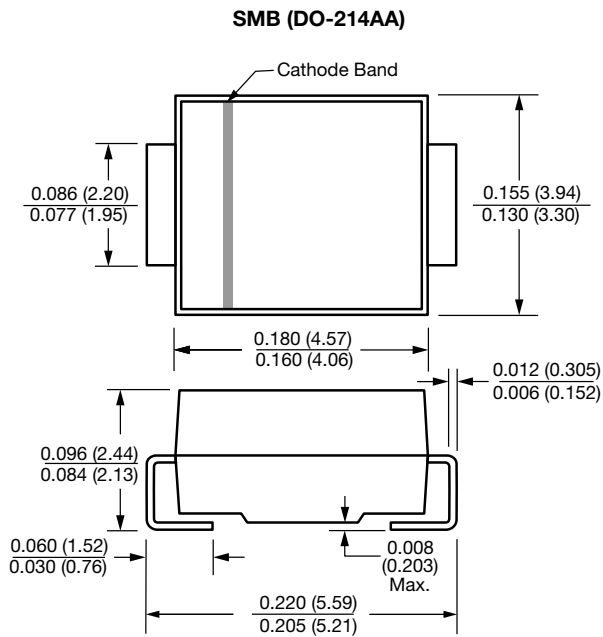

Fig. 6 - Maximum Non-Repetitive Peak Forward Surge Current

PACKAGE OUTLINE DIMENSIONS in inches (millimeters)





Disclaimer

ALL PRODUCT, PRODUCT SPECIFICATIONS AND DATA ARE SUBJECT TO CHANGE WITHOUT NOTICE TO IMPROVE RELIABILITY, FUNCTION OR DESIGN OR OTHERWISE.

Vishay Intertechnology, Inc., its affiliates, agents, and employees, and all persons acting on its or their behalf (collectively, "Vishay"), disclaim any and all liability for any errors, inaccuracies or incompleteness contained in any datasheet or in any other disclosure relating to any product.

Vishay makes no warranty, representation or guarantee regarding the suitability of the products for any particular purpose or the continuing production of any product. To the maximum extent permitted by applicable law, Vishay disclaims (i) any and all liability arising out of the application or use of any product, (ii) any and all liability, including without limitation special, consequential or incidental damages, and (iii) any and all implied warranties, including warranties of fitness for particular purpose, non-infringement and merchantability.

Statements regarding the suitability of products for certain types of applications are based on Vishay's knowledge of typical requirements that are often placed on Vishay products in generic applications. Such statements are not binding statements about the suitability of products for a particular application. It is the customer's responsibility to validate that a particular product with the properties described in the product specification is suitable for use in a particular application. Parameters provided in datasheets and / or specifications may vary in different applications and performance may vary over time. All operating parameters, including typical parameters, must be validated for each customer application by the customer's technical experts. Product specifications do not expand or otherwise modify Vishay's terms and conditions of purchase, including but not limited to the warranty expressed therein.

Except as expressly indicated in writing, Vishay products are not designed for use in medical, life-saving, or life-sustaining applications or for any other application in which the failure of the Vishay product could result in personal injury or death. Customers using or selling Vishay products not expressly indicated for use in such applications do so at their own risk. Please contact authorized Vishay personnel to obtain written terms and conditions regarding products designed for such applications.

No license, express or implied, by estoppel or otherwise, to any intellectual property rights is granted by this document or by any conduct of Vishay. Product names and markings noted herein may be trademarks of their respective owners.

Mouser Electronics

Authorized Distributor

Click to View Pricing, Inventory, Delivery & Lifecycle Information:

Vishay:

[SMBJ100A/2](#) [SMBJ100A/2B](#) [SMBJ100A/5](#) [SMBJ100A/52](#) [SMBJ100A/55](#) [SMBJ100A/5B](#) [SMBJ100A-E3/2C](#)
[SMBJ100A-E3/51](#) [SMBJ100A-E3/52](#) [SMBJ100A-E3/55](#) [SMBJ100A-E3/5B](#) [SMBJ100AHE3/2C](#) [SMBJ100AHE3/52](#)
[SMBJ100AHE3/55](#) [SMBJ100AHE3/5B](#) [SMBJ100CA/2](#) [SMBJ100CA/2B](#) [SMBJ100CA/5](#) [SMBJ100CA/52](#)
[SMBJ100CA/55](#) [SMBJ100CA/5B](#) [SMBJ100CA-E3/2C](#) [SMBJ100CA-E3/51](#) [SMBJ100CA-E3/52](#) [SMBJ100CA-E3/55](#)
[SMBJ100CA-E3/5B](#) [SMBJ100CAHE3/2C](#) [SMBJ100CAHE3/52](#) [SMBJ100CAHE3/55](#) [SMBJ100CAHE3/5B](#) [SMBJ10A/2](#)
[SMBJ10A/2B](#) [SMBJ10A/5](#) [SMBJ10A/52](#) [SMBJ10A/55](#) [SMBJ10A/5B](#) [SMBJ10A-E3/2](#) [SMBJ10A-E3/2C](#) [SMBJ10A-](#)
[E3/51](#) [SMBJ10A-E3/52](#) [SMBJ10A-E3/55](#) [SMBJ10A-E3/5B](#) [SMBJ10AHE3/2C](#) [SMBJ10AHE3/52](#) [SMBJ10AHE3/55](#)
[SMBJ10AHE3/5B](#) [SMBJ10CA/2](#) [SMBJ10CA/5](#) [SMBJ10CA/52](#) [SMBJ10CA/55](#) [SMBJ10CA/5B](#) [SMBJ10CA-E3/2C](#)
[SMBJ10CA-E3/51](#) [SMBJ10CA-E3/52](#) [SMBJ10CA-E3/55](#) [SMBJ10CA-E3/5B](#) [SMBJ10CAHE3/2C](#) [SMBJ10CAHE3/52](#)
[SMBJ10CAHE3/55](#) [SMBJ10CAHE3/5B](#) [SMBJ110A/2](#) [SMBJ110A/2B](#) [SMBJ110A/52](#) [SMBJ110A/5B](#) [SMBJ110A-](#)
[E3/2C](#) [SMBJ110A-E3/51](#) [SMBJ110A-E3/52](#) [SMBJ110A-E3/55](#) [SMBJ110A-E3/5B](#) [SMBJ110AHE3/2C](#)
[SMBJ110AHE3/52](#) [SMBJ110AHE3/55](#) [SMBJ110AHE3/5B](#) [SMBJ110CA/2](#) [SMBJ110CA/2B](#) [SMBJ110CA/5](#)
[SMBJ110CA/52](#) [SMBJ110CA/55](#) [SMBJ110CA/5B](#) [SMBJ110CA-E3/2C](#) [SMBJ110CA-E3/51](#) [SMBJ110CA-E3/52](#)
[SMBJ110CA-E3/55](#) [SMBJ110CA-E3/5B](#) [SMBJ110CAHE3/2C](#) [SMBJ110CAHE3/52](#) [SMBJ110CAHE3/55](#)
[SMBJ110CAHE3/5B](#) [SMBJ11A/2](#) [SMBJ11A/2B](#) [SMBJ11A/52](#) [SMBJ11A/55](#) [SMBJ11A-E3/2C](#) [SMBJ11A-E3/51](#)
[SMBJ11A-E3/52](#) [SMBJ11A-E3/55](#) [SMBJ11A-E3/5B](#) [SMBJ11AHE3/2C](#) [SMBJ11AHE3/52](#) [SMBJ11AHE3/55](#)