

High Current Density Standard Avalanche Surface Mount Rectifiers



FEATURES

- Very low profile - typical height of 1.1 mm
- Ideal for automated placement
- Glass passivated pellet chip junction
- Controlled avalanche characteristics
- Low leakage current
- High forward surge capability
- Meets MSL level 1, per J-STD-020, LF maximum peak of 260 °C
- AEC-Q101 qualified available
- Automotive ordering code: base P/NHM3
- Material categorization: for definitions of compliance please see www.vishay.com/doc?99912

TYPICAL APPLICATIONS

For use in general purpose rectification of power supplies, inverters, converters and freewheeling diodes for consumer, automotive and telecommunication.

DESIGN SUPPORT TOOLS

[click logo to get started](#)



PRIMARY CHARACTERISTICS	
$I_{F(AV)}$	4.0 A
V_{RRM}	200 V, 400 V, 600 V, 800 V, 1000 V
I_{FSM}	100 A
E_{AS}	20 mJ
V_F at $I_F = 4$ A	0.92 V
T_J max.	175 °C
Package	SMPC (TO-277A)
Circuit configuration	Single

MECHANICAL DATA

Case: SMPC (TO-277A)

Molding compound meets UL 94 V-0 flammability rating

Base P/N-M3 - halogen-free, RoHS-compliant, and commercial grade

Base P/NHM3_X - halogen-free, RoHS-compliant and AEC-Q101 qualified

("_X" denotes revision code e.g. A, B,....)

Terminals: matte tin plated leads, solderable per J-STD-002 and JESD 22-B102

M3 suffix meets JESD 201 class 1A whisker test, HM3 suffix meets JESD 201 class 2 whisker test

MAXIMUM RATINGS ($T_A = 25$ °C unless otherwise noted)							
PARAMETER	SYMBOL	AS4PD	AS4PG	AS4PJ	AS4PK	AS4PM	UNIT
Device marking code		AS4D	AS4G	AS4J	AS4K	AS4M	
Max. repetitive peak reverse voltage	V_{RRM}	200	400	600	800	1000	V
Max. DC forward current (fig. 1)	$I_F^{(1)}$	4.0					A
	$I_F^{(2)}$	2.4					
Peak forward surge current 10 ms single half sine-wave superimposed on rated load	I_{FSM}	100					A
Non-repetitive avalanche energy at $T_J = 25$ °C	$I_{AS} = 2.5$ A max.	20					mJ
	$I_{AS} = 1.0$ A typical	30					
Operating junction and storage temperature range	T_J, T_{STG}	-55 to +175					°C

Notes

- (1) Mounted on 20 mm x 20 mm pad areas, 1 oz. FR4 PCB
- (2) Free air, mounted on recommended copper pad area



ELECTRICAL CHARACTERISTICS ($T_A = 25\text{ }^\circ\text{C}$ unless otherwise noted)						
PARAMETER	TEST CONDITIONS		SYMBOL	TYP.	MAX.	UNIT
Instantaneous forward voltage	$I_F = 2.0\text{ A}$	$T_A = 25\text{ }^\circ\text{C}$	$V_F^{(1)}$	0.962	-	V
	$I_F = 4.0\text{ A}$			1.044	1.10	
	$I_F = 2.0\text{ A}$	$T_A = 125\text{ }^\circ\text{C}$		0.822	-	
	$I_F = 4.0\text{ A}$			0.922	0.98	
Reverse current	rated V_R	$T_A = 25\text{ }^\circ\text{C}$	$I_R^{(2)}$	0.35	10	μA
		$T_A = 125\text{ }^\circ\text{C}$		75	150	
Typical reverse recovery time	$I_F = 0.5\text{ A}$, $I_R = 1.0\text{ A}$, $t_{rr} = 0.25\text{ A}$		t_{rr}	1.8	-	μs
Typical junction capacitance per diode	4.0 V, 1 MHz		C_J	60	-	pF

Notes(1) Pulse test: 300 μs pulse width, 1 % duty cycle(2) Pulse test: Pulse width $\leq 40\text{ ms}$

THERMAL CHARACTERISTICS ($T_A = 25\text{ }^\circ\text{C}$ unless otherwise noted)							
PARAMETER	SYMBOL	AS4PD	AS4PG	AS4PJ	AS4PK	AS4PM	UNIT
Typical thermal resistance	$R_{\theta JA}^{(1)}$	80					$^\circ\text{C/W}$
	$R_{\theta JM}^{(2)}$	5					

Notes(1) Free air, mounted on recommended PCB 1 oz. pad area; thermal resistance $R_{\theta JA}$ - junction to ambient(2) Units mounted on PCB with 20 mm x 20 mm copper pad areas, 1 oz. FR4 PCB; $R_{\theta JM}$ - junction to mount

ORDERING INFORMATION (Example)				
PREFERRED P/N	UNIT WEIGHT (g)	PREFERRED PACKAGE CODE	BASE QUANTITY	DELIVERY MODE
AS4PJ-M3/86A	0.10	86A	1500	7" diameter plastic tape and reel
AS4PJ-M3/87A	0.10	87A	6500	13" diameter plastic tape and reel
AS4PJHM3_A/H ⁽¹⁾	0.10	H	1500	7" diameter plastic tape and reel
AS4PJHM3_A/I ⁽¹⁾	0.10	I	6500	13" diameter plastic tape and reel

Note

(1) AEC-Q101 qualified



RATINGS AND CHARACTERISTICS CURVES ($T_A = 25\text{ }^\circ\text{C}$ unless otherwise noted)

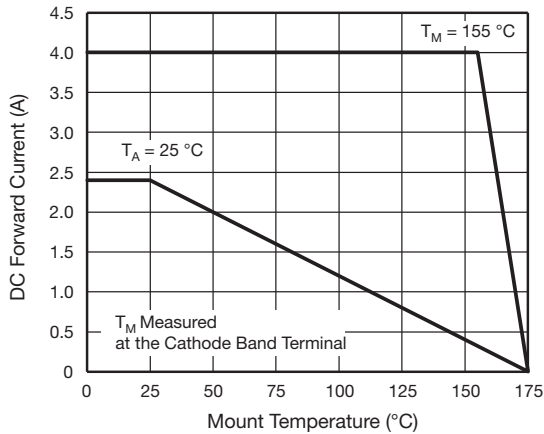

Fig. 1 - Max. Forward Current Derating Curve

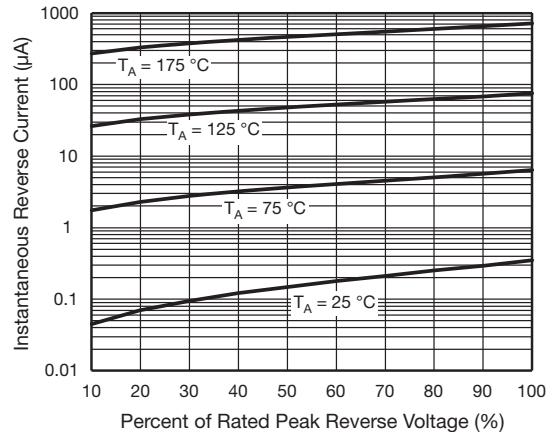

Fig. 4 - Typical Reverse Leakage Characteristics

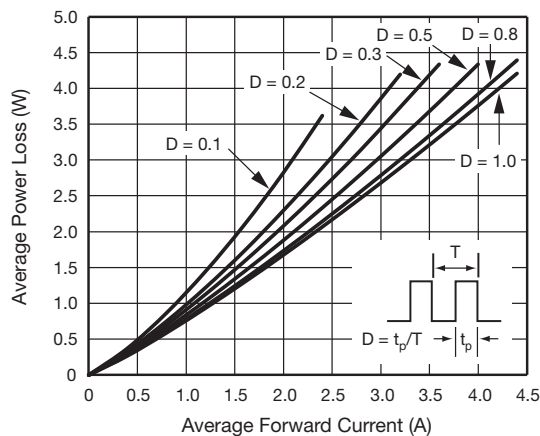

Fig. 2 - Forward Power Loss Characteristics

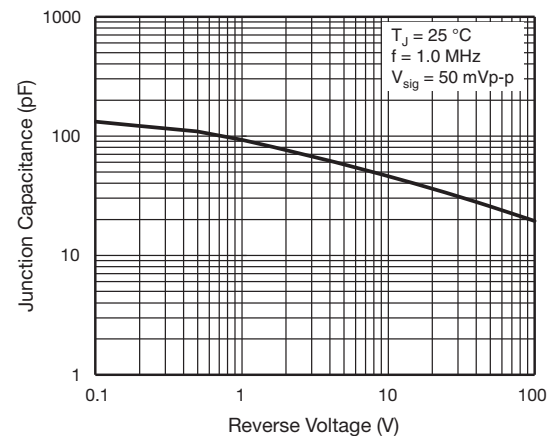

Fig. 5 - Typical Junction Capacitance

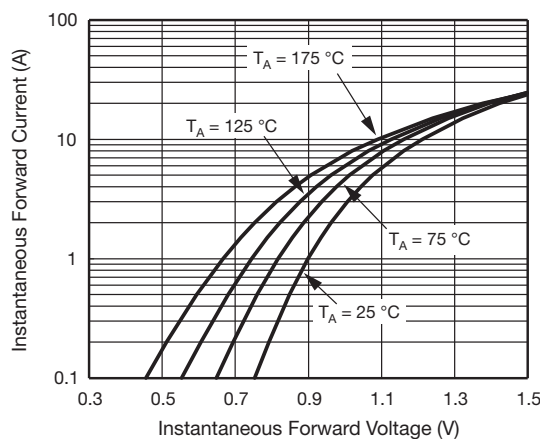

Fig. 3 - Typical Instantaneous Forward Characteristics

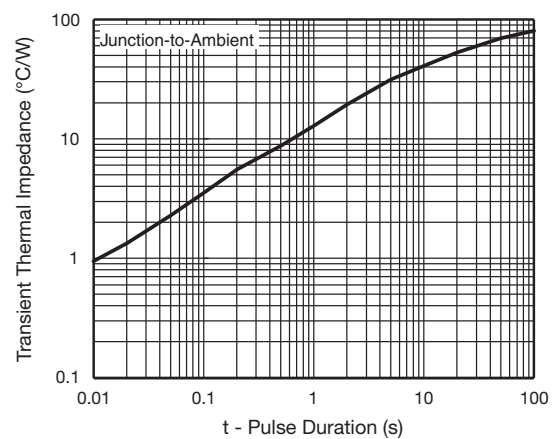
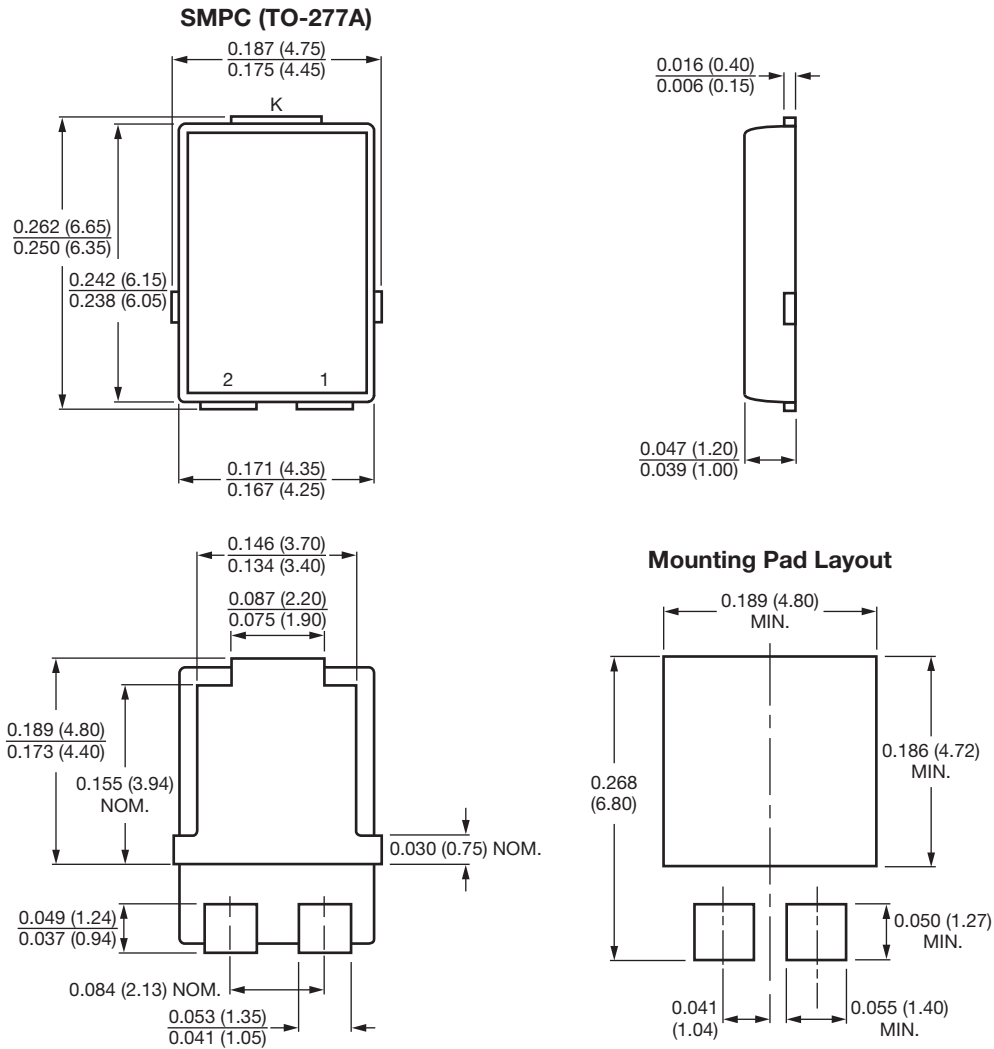

Fig. 6 - Typical Transient Thermal Impedance



PACKAGE OUTLINE DIMENSIONS in inches (millimeters)





Disclaimer

ALL PRODUCT, PRODUCT SPECIFICATIONS AND DATA ARE SUBJECT TO CHANGE WITHOUT NOTICE TO IMPROVE RELIABILITY, FUNCTION OR DESIGN OR OTHERWISE.

Vishay Intertechnology, Inc., its affiliates, agents, and employees, and all persons acting on its or their behalf (collectively, "Vishay"), disclaim any and all liability for any errors, inaccuracies or incompleteness contained in any datasheet or in any other disclosure relating to any product.

Vishay makes no warranty, representation or guarantee regarding the suitability of the products for any particular purpose or the continuing production of any product. To the maximum extent permitted by applicable law, Vishay disclaims (i) any and all liability arising out of the application or use of any product, (ii) any and all liability, including without limitation special, consequential or incidental damages, and (iii) any and all implied warranties, including warranties of fitness for particular purpose, non-infringement and merchantability.

Statements regarding the suitability of products for certain types of applications are based on Vishay's knowledge of typical requirements that are often placed on Vishay products in generic applications. Such statements are not binding statements about the suitability of products for a particular application. It is the customer's responsibility to validate that a particular product with the properties described in the product specification is suitable for use in a particular application. Parameters provided in datasheets and / or specifications may vary in different applications and performance may vary over time. All operating parameters, including typical parameters, must be validated for each customer application by the customer's technical experts. Product specifications do not expand or otherwise modify Vishay's terms and conditions of purchase, including but not limited to the warranty expressed therein.

Except as expressly indicated in writing, Vishay products are not designed for use in medical, life-saving, or life-sustaining applications or for any other application in which the failure of the Vishay product could result in personal injury or death. Customers using or selling Vishay products not expressly indicated for use in such applications do so at their own risk. Please contact authorized Vishay personnel to obtain written terms and conditions regarding products designed for such applications.

No license, express or implied, by estoppel or otherwise, to any intellectual property rights is granted by this document or by any conduct of Vishay. Product names and markings noted herein may be trademarks of their respective owners.