

Please read this notice before using the TAIYO YUDEN products.

## REMINDERS

- Product information in this catalog is as of October 2017. All of the contents specified herein are subject to change without notice due to technical improvements, etc. Therefore, please check for the latest information carefully before practical application or use of our products.

Please note that TAIYO YUDEN shall not be in any way responsible for any damages and defects in products or equipment incorporating our products, which are caused under the conditions other than those specified in this catalog or individual product specification sheets.

- Please contact TAIYO YUDEN for further details of product specifications as the individual product specification sheets are available.
- Please conduct validation and verification of our products in actual condition of mounting and operating environment before using our products.
- The products listed in this catalog are intended for use in general electronic equipment (e.g., AV equipment, OA equipment, home electric appliances, office equipment, information and communication equipment including, without limitation, mobile phone, and PC) and medical equipment classified as Class I or II by IMDRF. Please be sure to contact TAIYO YUDEN for further information before using the products for any equipment which may directly cause loss of human life or bodily injury (e.g., transportation equipment including, without limitation, automotive powertrain control system, train control system, and ship control system, traffic signal equipment, disaster prevention equipment, medical equipment classified as Class III by IMDRF, highly public information network equipment including, without limitation, telephone exchange, and base station).

Please do not incorporate our products into any equipment requiring high levels of safety and/or reliability (e.g., aerospace equipment, aviation equipment\*, medical equipment classified as Class IV by IMDRF, nuclear control equipment, undersea equipment, military equipment).

\*Note: There is a possibility that our products can be used only for aviation equipment that does not directly affect the safe operation of aircraft (e.g., in-flight entertainment, cabin light, electric seat, cooking equipment) if such use meets requirements specified separately by TAIYO YUDEN. Please be sure to contact TAIYO YUDEN for further information before using our products for such aviation equipment.

When our products are used even for high safety and/or reliability-required devices or circuits of general electronic equipment, it is strongly recommended to perform a thorough safety evaluation prior to use of our products and to install a protection circuit as necessary.

Please note that unless you obtain prior written consent of TAIYO YUDEN, TAIYO YUDEN shall not be in any way responsible for any damages incurred by you or third parties arising from use of the products listed in this catalog for any equipment requiring inquiry to TAIYO YUDEN or prohibited for use by TAIYO YUDEN as described above.

- Information contained in this catalog is intended to convey examples of typical performances and/or applications of our products and is not intended to make any warranty with respect to the intellectual property rights or any other related rights of TAIYO YUDEN or any third parties nor grant any license under such rights.
- Please note that the scope of warranty for our products is limited to the delivered our products themselves and TAIYO YUDEN shall not be in any way responsible for any damages resulting from a fault or defect in our products. Notwithstanding the foregoing, if there is a written agreement (e.g., supply and purchase agreement, quality assurance agreement) signed by TAIYO YUDEN and your company, TAIYO YUDEN will warrant our products in accordance with such agreement.
- The contents of this catalog are applicable to our products which are purchased from our sales offices or authorized distributors (hereinafter "TAIYO YUDEN's official sales channel"). Please note that the contents of this catalog are not applicable to our products purchased from any seller other than TAIYO YUDEN's official sales channel.
- Caution for Export  
Some of our products listed in this catalog may require specific procedures for export according to "U.S. Export Administration Regulations", "Foreign Exchange and Foreign Trade Control Law" of Japan, and other applicable regulations. Should you have any questions on this matter, please contact our sales staff.

# MULTILAYER COMMON MODE CHOKE COILS(MC SERIES F TYPE)



REFLOW

■ PARTS NUMBER

\* Operating Temp.: -40~+85°C

M	C	F	0	8	0	6	2	G	1	2	0	-	T	△
①			②				③	④			⑤		⑥	⑦

△=Blank space

① Series name

Code	Series name
MCF	Multilayer common mode choke coil

② Dimensions

Code	Dimensions [mm]
0605	0.65 × 0.50
0806	0.85 × 0.65
1210	1.25 × 1.0
2010	2.0 × 1.0

③ No. of Lines

Code	No. of Lines
2	2 lines
4	4 lines

④ Material

Code	Material
G	Refer to impedance curves for material differences
E	
H	

⑤ Nominal common impedance

Code (example)	Nominal common impedance [Ω]
120	12
900	90

⑥ Packaging

Code	Packaging
-T	Taping

⑦ Internal code

Code	Internal code
△	Standard

■ STANDARD EXTERNAL DIMENSIONS / STANDARD QUANTITY / EQUIVALENT CIRCUIT

2 LINES

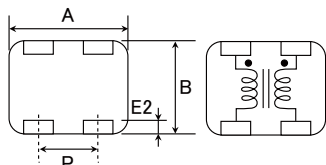
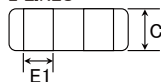

Equivalent Circuit  
• No polarity

4 LINES

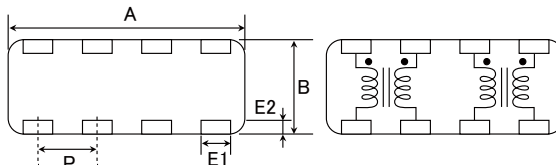

Equivalent Circuit  
• No polarity

Type	A	B	C	E1	E2	P	Standard quantity [pcs] Taping
MCF0605	0.65±0.05 (0.026±0.002)	0.50±0.05 (0.020±0.002)	0.30±0.05 (0.012±0.002)	0.15±0.1 (0.006±0.004)	0.12±0.1 (0.005±0.004)	0.40±0.10 (0.016±0.004)	15000
MCF0806	0.85±0.05 (0.033±0.002)	0.65±0.05 (0.026±0.002)	0.40±0.05 (0.016±0.002)	0.27±0.1 (0.011±0.004)	0.2 +0.05/-0.1 (0.008 +0.002/-0.004)	0.50±0.10 (0.020±0.004)	10000
MCF1210	1.0±0.15 (0.039±0.006)	1.25±0.15 (0.049±0.006)	0.55±0.1 (0.022±0.004)	0.3±0.1 (0.012±0.004)	0.2±0.1 (0.008±0.004)	0.55±0.10 (0.022±0.004)	5000
MCF2010	2.0±0.15 (0.079±0.006)	1.0±0.15 (0.039±0.006)	0.45±0.1 (0.018±0.004)	0.25 +0.15/-0.1 (0.010 +0.006/-0.004)	0.25±0.15 (0.010±0.006)	0.50±0.10 (0.020±0.004)	4000

Unit: mm (inch)

► This catalog contains the typical specification only due to the limitation of space. When you consider the purchase of our products, please check our product specification sheets. For details of each product (characteristics graph, reliability information, precautions for use, and so on), see our website (<http://www.ty-top.com/>).

■ PARTS NUMBER

● MCF0605 type

Parts number	EHS	No. of Lines	Common mode impedance [Ω]	Measuring frequency [MHz]	DC Resistance [Ω] (max.)	Rated current [A] (max.)	Rated voltage [V]	Insulation resistance [MΩ] (min.)
MCF0605 2G120-T	RoHS	2	12±5	100	2.5	0.05	5	100
MCF0605 2G350-T	RoHS	2	35±20%	100	5.0	0.05	5	100
MCF0605 2E600-T	RoHS	2	60±25%	100	3.5	0.05	5	100
MCF0605 2E900-T	RoHS	2	90±20%	100	3.9	0.05	5	100

● MCF0806 type

Parts number	EHS	No. of Lines	Common mode impedance [Ω]	Measuring frequency [MHz]	DC Resistance [Ω] (max.)	Rated current [A] (max.)	Rated voltage [V]	Insulation resistance [MΩ] (min.)
MCF0806 2G120-T	RoHS	2	12±5	100	2.5	0.13	5	100
MCF0806 2G470-T	RoHS	2	47±20%	100	4.0	0.10	5	100
MCF0806 2G900-T	RoHS	2	90±20%	100	5.0	0.10	5	100
MCF0806 2E300-T	RoHS	2	30±25%	100	1.5	0.15	5	100

● MCF1210 type

Parts number	EHS	No. of Lines	Common mode impedance [Ω]	Measuring frequency [MHz]	DC Resistance [Ω] (max.)	Rated current [A] (max.)	Rated voltage [V]	Insulation resistance [MΩ] (min.)
MCF1210 2G400-T	RoHS	2	40±25%	100	2.5	0.10	5	100
MCF1210 2G900-T	RoHS	2	90±25%	100	4.5	0.10	5	100
MCF1210 2H500-T	RoHS	2	50±25%	100	1.5	0.16	5	100
MCF1210 2H900-T	RoHS	2	90±20%	100	2.5	0.15	5	100

● MCF2010 type

Parts number	EHS	No. of Lines	Common mode impedance [Ω]	Measuring frequency [MHz]	DC Resistance [Ω] (max.)	Rated current [A] (max.)	Rated voltage [V]	Insulation resistance [MΩ] (min.)
MCF2010 4G900-T	RoHS	4	90±25%	100	4.5	0.10	5	100

■ ELECTRICAL CHARACTERISTICS

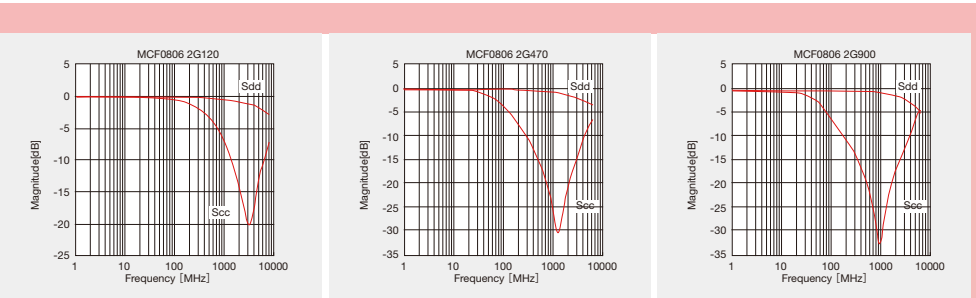

▶ This catalog contains the typical specification only due to the limitation of space. When you consider the purchase of our products, please check our product specification sheets. For details of each product (characteristics graph, reliability information, precautions for use, and so on), see our website (<http://www.ty-top.com/>).

## Multilayer chip inductors

Multilayer chip inductors for high frequency, Multilayer chip bead inductors

Multilayer common mode choke coils (MC series F type)

Metal Multilayer Chip Power Inductors (MCOIL™ MC series)

### PACKAGING

#### ① Minimum Quantity

#### ● Tape & Reel Packaging

Type	Thickness mm (inch)	Standard Quantity [pcs]	
		Paper Tape	Embossed Tape
CK1608(0603)	0.8 (0.031)	4000	—
CK2125(0805)	0.85(0.033)	4000	—
	1.25(0.049)	—	2000
CKS2125(0805)	0.85(0.033)	4000	—
	1.25(0.049)	—	2000
CKP1608(0603)	0.8 (0.031)	4000	—
CKP2012(0805)	0.9 (0.035)	—	3000
CKP2016(0806)	0.9 (0.035)	—	3000
CKP2520(1008)	0.7 (0.028)	—	3000
	0.9 (0.035)	—	3000
	1.1 (0.043)	—	2000
NM2012(0805)	0.9 (0.035)	—	3000
NM2520(1008)	0.9 (0.035)	—	3000
	1.1 (0.043)	—	2000
LK1005(0402)	0.5 (0.020)	10000	—
LK1608(0603)	0.8 (0.031)	4000	—
LK2125(0805)	0.85(0.033)	4000	—
	1.25(0.049)	—	2000
HK0603(0201)	0.3 (0.012)	15000	—
HK1005(0402)	0.5 (0.020)	10000	—
HK1608(0603)	0.8 (0.031)	4000	—
HK2125(0805)	0.85(0.033)	—	4000
	1.0 (0.039)	—	3000
HKQ0402(01005)	0.2 (0.008)	20000	40000
HKQ0603W(0201)	0.3 (0.012)	15000	—
HKQ0603S(0201)	0.3 (0.012)	15000	—
HKQ0603U(0201)	0.3 (0.012)	15000	—
AQ105(0402)	0.5 (0.020)	10000	—
BK0402(01005)	0.2 (0.008)	20000	—
BK0603(0201)	0.3 (0.012)	15000	—
BK1005(0402)	0.5 (0.020)	10000	—
BKH0603(0201)	0.3 (0.012)	15000	—
BKH1005(0402)	0.5 (0.020)	10000	—
BK1608(0603)	0.8 (0.031)	4000	—
BK2125(0805)	0.85(0.033)	4000	—
	1.25(0.049)	—	2000
BK2010(0804)	0.45(0.018)	4000	—
BK3216(1206)	0.8 (0.031)	—	4000
BKP0402(01005)	0.2 (0.008)	20000	—
BKP0603(0201)	0.3 (0.012)	15000	—
BKP1005(0402)	0.5 (0.020)	10000	—
BKP1608(0603)	0.8 (0.031)	4000	—
BKP2125(0805)	0.85(0.033)	4000	—
MCF0605(0202)	0.3 (0.012)	15000	—
MCF0806(0302)	0.4 (0.016)	—	10000
MCF1210(0504)	0.55(0.022)	—	5000
MCF2010(0804)	0.45(0.018)	—	4000
MCFK1608(0603)	0.6 (0.024)	4000	—
MCFE1608(0603)	0.65(0.026)	4000	—
MCKK1608(0603)	1.0(0.039)	—	3000
MCHK2012(0806)	0.8 (0.031)	4000	—
MCKK2012(0805)	1.0(0.039)	—	3000

▶ This catalog contains the typical specification only due to the limitation of space. When you consider the purchase of our products, please check our specification. For details of each product (characteristics graph, reliability information, precautions for use, and so on), see our Web site (<http://www.ty-top.com/>).

## ② Taping material

### ● Card board carrier tape

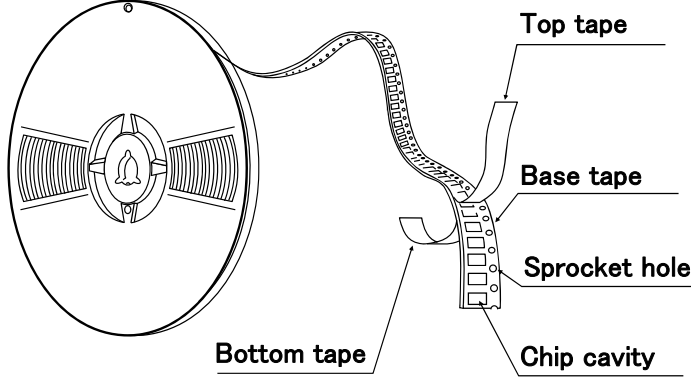

CK	1608
CKP	1608
CK	2125
CKS	2125
LK	1005
LK	1608
LK	2125
HK	0603
HK	1005
HK	1608
HKQ	0402
HKQ	0603
AQ	105

BK	0402
BK	0603
BK	1005
BK	1608
BK	2125
BK	2010
BKP	0402
BKP	0603
BKP	1005
BKP	1608
BKP	2125
BKH	0603
BKH	1005
MCF	0605
MC	1608
MC	2012

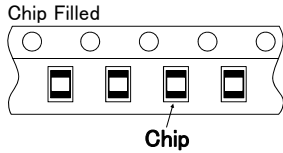

### ● Embossed Tape

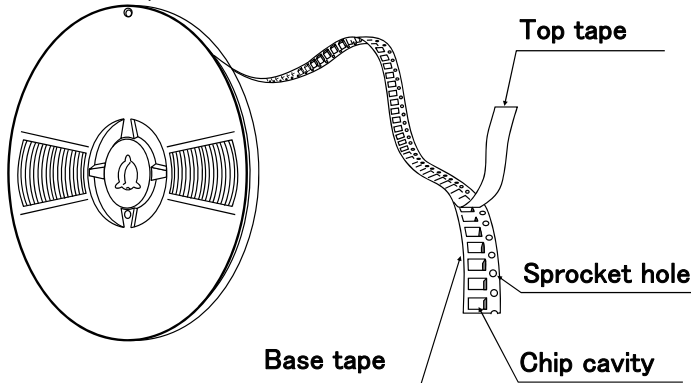

CK	2125
CKS	2125
CKP	2012
CKP	2016
CKP	2520
NM	2012
NM	2520
LK	2125
HKQ	0402
HK	2125

BK	2125
BK	3216
MCF	0806
MCF	1210
MCF	2010
MC	1608
MC	2012



## ③ Taping Dimensions

### ● Paper tape (8mm wide)

Unit: mm (inch)

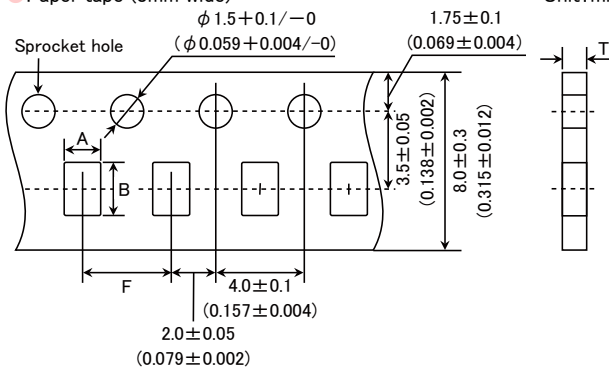

▶ This catalog contains the typical specification only due to the limitation of space. When you consider the purchase of our products, please check our specification. For details of each product (characteristics graph, reliability information, precautions for use, and so on), see our Web site (<http://www.ty-top.com/>).

Type	Thickness mm (inch)	Chip cavity		Insertion Pitch	Tape Thickness
		A	B	F	T
CK1608(0603)	0.8 (0.031)	1.0±0.2 (0.039±0.008)	1.8±0.2 (0.071±0.008)	4.0±0.1 (0.157±0.004)	1.1max (0.043max)
CK2125(0805)	0.85(0.033)	1.5±0.2 (0.059±0.008)	2.3±0.2 (0.091±0.008)	4.0±0.1 (0.157±0.004)	1.1max (0.043max)
CKS2125(0805)	0.85(0.033)	1.5±0.2 (0.059±0.008)	2.3±0.2 (0.091±0.008)	4.0±0.1 (0.157±0.004)	1.1max (0.043max)
CKP1608(0603)	0.8 (0.031)	1.0±0.2 (0.039±0.008)	1.8±0.2 (0.071±0.008)	4.0±0.1 (0.157±0.004)	1.1max (0.043max)
LK1005(0402)	0.5 (0.020)	0.65±0.1 (0.026±0.004)	1.15±0.1 (0.045±0.004)	2.0±0.05 (0.079±0.002)	0.8max (0.031max)
LK1608(0603)	0.8 (0.031)	1.0±0.2 (0.039±0.008)	1.8±0.2 (0.071±0.008)	4.0±0.1 (0.157±0.004)	1.1max (0.043max)
LK2125(0805)	0.85(0.033)	1.5±0.2 (0.059±0.008)	2.3±0.2 (0.091±0.008)	4.0±0.1 (0.157±0.004)	1.1max (0.043max)
HK0603(0201)	0.3 (0.012)	0.40±0.06 (0.016±0.002)	0.70±0.06 (0.028±0.002)	2.0±0.05 (0.079±0.002)	0.45max (0.018max)
HK1005(0402)	0.5 (0.020)	0.65±0.1 (0.026±0.004)	1.15±0.1 (0.045±0.004)	2.0±0.05 (0.079±0.002)	0.8max (0.031max)
HK1608(0603)	0.8 (0.031)	1.0±0.2 (0.039±0.008)	1.8±0.2 (0.071±0.008)	4.0±0.1 (0.157±0.004)	1.1max (0.043max)
HKQ0402(01005)	0.2 (0.008)	0.25±0.04 (0.010±0.002)	0.45±0.04 (0.018±0.002)	2.0±0.05 (0.079±0.002)	0.36max (0.014max)
HKQ0603W(0201)	0.3 (0.012)	0.40±0.06 (0.016±0.002)	0.70±0.06 (0.028±0.002)	2.0±0.05 (0.079±0.002)	0.45max (0.018max)
HKQ0603S(0201)	0.3 (0.012)	0.40±0.06 (0.016±0.002)	0.70±0.06 (0.028±0.002)	2.0±0.05 (0.079±0.002)	0.45max (0.018max)
HKQ0603U(0201)	0.3 (0.012)	0.40±0.06 (0.016±0.002)	0.70±0.06 (0.028±0.002)	2.0±0.05 (0.079±0.002)	0.45max (0.018max)
AQ105(0402)	0.5 (0.020)	0.75±0.1 (0.030±0.004)	1.15±0.1 (0.045±0.004)	2.0±0.05 (0.079±0.002)	0.8max (0.031max)
BK0402(01005)	0.2 (0.008)	0.25±0.04 (0.010±0.002)	0.45±0.04 (0.018±0.002)	2.0±0.05 (0.079±0.002)	0.36max (0.014max)
BK0603(0201)	0.3 (0.012)	0.40±0.06 (0.016±0.002)	0.70±0.06 (0.028±0.002)	2.0±0.05 (0.079±0.002)	0.45max (0.018max)
BK1005(0402)	0.5 (0.020)	0.65±0.1 (0.026±0.004)	1.15±0.1 (0.045±0.004)	2.0±0.05 (0.079±0.002)	0.8max (0.031max)
BK1608(0603)	0.8 (0.031)	1.0±0.2 (0.039±0.008)	1.8±0.2 (0.071±0.008)	4.0±0.1 (0.157±0.004)	1.1max (0.043max)
BK2125(0805)	0.85(0.033)	1.5±0.2 (0.059±0.008)	2.3±0.2 (0.091±0.008)	4.0±0.1 (0.157±0.004)	1.1max (0.043max)
BK2010(0804)	0.45(0.018)	1.2±0.1 (0.047±0.004)	2.17±0.1 (0.085±0.004)	4.0±0.1 (0.157±0.004)	0.8max (0.031max)
BKP0402(01005)	0.2 (0.008)	0.25±0.04 (0.010±0.002)	0.45±0.04 (0.018±0.002)	2.0±0.05 (0.079±0.002)	0.36max (0.014max)
BKP0603(0201)	0.3 (0.012)	0.40±0.06 (0.016±0.002)	0.70±0.06 (0.028±0.002)	2.0±0.05 (0.079±0.002)	0.45max (0.018max)
BKP1005(0402)	0.5 (0.020)	0.65±0.1 (0.026±0.004)	1.15±0.1 (0.045±0.004)	2.0±0.05 (0.079±0.002)	0.8max (0.031max)
BKP1608(0603)	0.8 (0.031)	1.0±0.2 (0.039±0.008)	1.8±0.2 (0.071±0.008)	4.0±0.1 (0.157±0.004)	1.1max (0.043max)
BKP2125(0805)	0.85(0.033)	1.5±0.2 (0.059±0.008)	2.3±0.2 (0.091±0.008)	4.0±0.1 (0.157±0.004)	1.1max (0.043max)
BKH0603(0201)	0.3 (0.012)	0.40±0.06 (0.016±0.002)	0.70±0.06 (0.028±0.002)	2.0±0.05 (0.079±0.002)	0.45max (0.018max)
BKH1005(0402)	0.5 (0.020)	0.65±0.1 (0.026±0.004)	1.15±0.1 (0.045±0.004)	2.0±0.05 (0.079±0.002)	0.8max (0.031max)
MCF0605(0202)	0.3 (0.012)	0.62±0.03 (0.024±0.001)	0.77±0.03 (0.030±0.001)	2.0±0.05 (0.079±0.002)	0.45max (0.018max)
MCFK1608(0603)	0.6 (0.024)	1.1±0.05 (0.043±0.002)	1.9±0.05 (0.075±0.002)	4.0±0.1 (0.157±0.004)	0.72max (0.028max)
MCFE1608(0603)	0.65(0.026)	1.1±0.05 (0.043±0.002)	1.9±0.05 (0.075±0.002)	4.0±0.1 (0.157±0.004)	0.9max (0.035max)
MCHK2012(0805)	0.8 (0.031)	1.55±0.2 (0.061±0.008)	2.3±0.2 (0.091±0.008)	4.0±0.1 (0.157±0.004)	0.9max (0.035max)

Unit : mm (inch)

● Embossed Tape (8mm wide)

Unit : mm (inch)

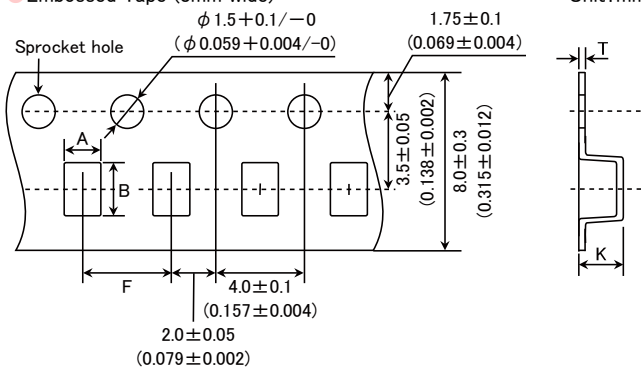

Type	Thickness mm (inch)	Chip cavity		Insertion Pitch F	Tape Thickness	
		A	B		K	T
CK2125 (0805)	1.25 (0.049)	1.5 ± 0.2 (0.059 ± 0.008)	2.3 ± 0.2 (0.091 ± 0.008)	4.0 ± 0.1 (0.157 ± 0.004)	2.0 (0.079)	0.3 (0.012)
CKS2125 (0805)	1.25 (0.049)	1.5 ± 0.2 (0.059 ± 0.008)	2.3 ± 0.2 (0.091 ± 0.008)	4.0 ± 0.1 (0.157 ± 0.004)	2.0 (0.079)	0.3 (0.012)
CKP2012 (0805)	0.9 (0.035)	1.55 ± 0.2 (0.061 ± 0.008)	2.3 ± 0.2 (0.091 ± 0.008)	4.0 ± 0.1 (0.157 ± 0.004)	1.3 (0.051)	0.3 (0.012)
CKP2016 (0806)	0.9 (0.035)	1.8 ± 0.1 (0.071 ± 0.004)	2.2 ± 0.1 (0.087 ± 0.004)	4.0 ± 0.1 (0.157 ± 0.004)	1.3 (0.051)	0.25 (0.01)
CKP2520 (1008)	0.7 (0.028)	2.3 ± 0.1 (0.091 ± 0.004)	2.8 ± 0.1 (0.110 ± 0.004)	4.0 ± 0.1 (0.157 ± 0.004)	1.4 (0.055)	0.3 (0.012)
	0.9 (0.035)				1.4 (0.055)	
	1.1 (0.043)				1.7 (0.067)	
NM2012 (0805)	0.9 (0.035)	1.55 ± 0.2 (0.061 ± 0.008)	2.3 ± 0.2 (0.091 ± 0.008)	4.0 ± 0.1 (0.157 ± 0.004)	1.3 (0.051)	0.3 (0.012)
NM2520 (1008)	0.9 (0.035)	2.3 ± 0.1 (0.091 ± 0.004)	2.8 ± 0.1 (0.110 ± 0.004)	4.0 ± 0.1 (0.157 ± 0.004)	1.4 (0.055)	0.3 (0.012)
	1.1 (0.043)				1.7 (0.067)	
LK2125 (0805)	1.25 (0.049)	1.5 ± 0.2 (0.059 ± 0.008)	2.3 ± 0.2 (0.091 ± 0.008)	4.0 ± 0.1 (0.157 ± 0.004)	2.0 (0.079)	0.3 (0.012)
HK2125 (0805)	0.85 (0.033)	1.5 ± 0.2 (0.059 ± 0.008)	2.3 ± 0.2 (0.091 ± 0.008)	4.0 ± 0.1 (0.157 ± 0.004)	1.5 (0.059)	0.3 (0.012)
	1.0 (0.039)				2.0 (0.079)	
BK2125 (0805)	1.25 (0.049)	1.5 ± 0.2 (0.059 ± 0.008)	2.3 ± 0.2 (0.091 ± 0.008)	4.0 ± 0.1 (0.157 ± 0.004)	2.0 (0.079)	0.3 (0.012)
BK3216 (1206)	0.8 (0.031)	1.9 ± 0.1 (0.075 ± 0.004)	3.5 ± 0.1 (0.138 ± 0.004)	4.0 ± 0.1 (0.157 ± 0.004)	1.4 (0.055)	0.3 (0.012)
MCF0806 (0302)	0.4 (0.016)	0.75 ± 0.05 (0.030 ± 0.002)	0.95 ± 0.05 (0.037 ± 0.002)	2.0 ± 0.05 (0.079 ± 0.002)	0.55 (0.022)	0.3 (0.012)
MCF1210 (0504)	0.55 (0.022)	1.15 ± 0.05 (0.045 ± 0.002)	1.40 ± 0.05 (0.055 ± 0.002)	4.0 ± 0.1 (0.157 ± 0.004)	0.65 (0.026)	0.3 (0.012)
MCF2010 (0804)	0.45 (0.018)	1.1 ± 0.1 (0.043 ± 0.004)	2.3 ± 0.1 (0.091 ± 0.004)	4.0 ± 0.1 (0.157 ± 0.004)	0.85 (0.033)	0.3 (0.012)
MCKK1608 (0603)	1.0 (0.039)	1.1 ± 0.1 (0.043 ± 0.004)	1.95 ± 0.1 (± 0.004)	4.0 ± 0.1 (0.157 ± 0.004)	1.4 (0.055)	0.25 (0.01)
MCKK2012 (0805)	1.0 (0.039)	1.55 ± 0.2 (0.061 ± 0.008)	2.3 ± 0.2 (0.091 ± 0.008)	4.0 ± 0.1 (0.157 ± 0.004)	1.35 (0.053)	0.25 (0.010)

Unit : mm (inch)

► This catalog contains the typical specification only due to the limitation of space. When you consider the purchase of our products, please check our specification. For details of each product (characteristics graph, reliability information, precautions for use, and so on), see our Web site (<http://www.ty-top.com/>).

● Embossed Tape (4mm wide)

Unit : mm (inch)

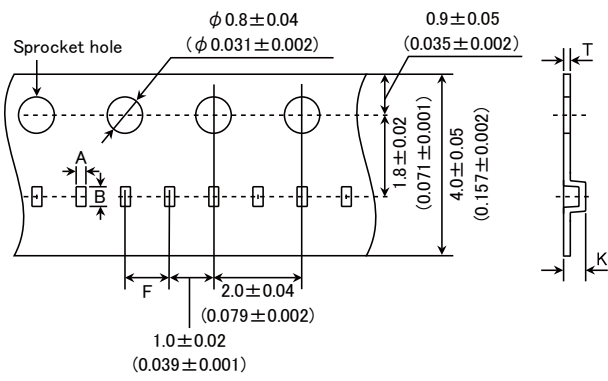

Type	Thickness mm (inch)	Chip cavity		Insertion Pitch F	Tape Thickness	
		A	B		K	T
HKQ0402 (01005)	0.2 (0.008)	0.23	0.43	1.0 ± 0.02	0.5max.	0.25max.

Unit : mm

④ LEADER AND BLANK PORTION

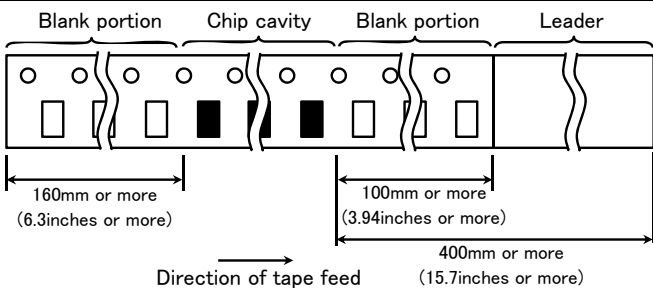

⑤ Reel Size

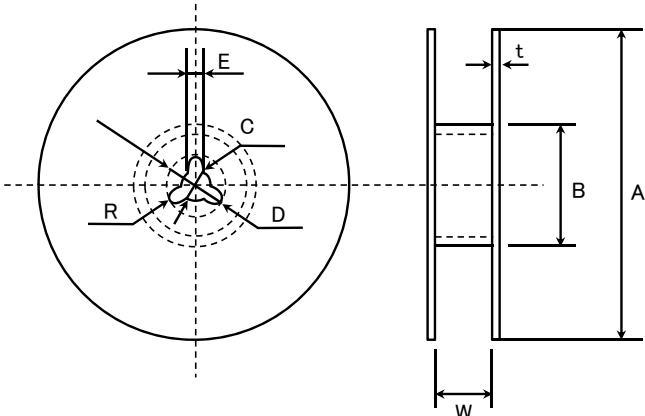

A	B	C	D	E	R
$\phi 178 \pm 2.0$	$\phi 50$ or more	$\phi 13.0 \pm 0.2$	$\phi 21.0 \pm 0.8$	$2.0 \pm 0.5$	1.0

	t	W
4mm width tape	1.5max.	$5 \pm 1.0$
8mm width tape	2.5max.	$10 \pm 1.5$

(Unit : mm)

⑥ Top tape strength

The top tape requires a peel-off force of 0.1~0.7N in the direction of the arrow as illustrated below.

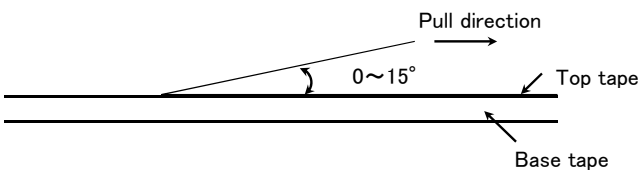

▶ This catalog contains the typical specification only due to the limitation of space. When you consider the purchase of our products, please check our specification. For details of each product (characteristics graph, reliability information, precautions for use, and so on), see our Web site (<http://www.ty-top.com/>).



## Multilayer chip inductors

Multilayer chip inductors for high frequency, Multilayer chip bead inductors

Multilayer common mode choke coils (MC series F type)

Metal Multilayer Chip Power Inductors (MCOIL™ MC series)

### RELIABILITY DATA

1. Operating Temperature Range			
Specified Value	BK0402	-55~+125°C	
	BK0603		
	BK1005		
	BKH0603		
	BKH1005		
	BK1608		
	BK2125		
	ARRAY		BK2010
			BK3216
	BKP0402		-55~+85°C
	BKP0603		
	BKP1005		
	BKP1608		
	BKP2125		
	MCF 0605	-40~+85°C	
	MCF 0806		
	MCF 1210		
	MCF 2010		
	CK1608	-40~+85°C	
	CK2125		
	CKS2125		
	CKP1608		
	CKP2012		
	CKP2016		
	CKP2520		
	NM2012		
	NM2520		
	LK1005		
	LK1608	-55~+125°C	
	LK2125		
	HKQ0402		
	HK0603	-40~+85°C	
HK1005			
HK1608	-55~+125°C		
HK2125			
HKQ0603W/HKQ0603S/HKQ0603U	-40~+125°C (Including self-generated heat)		
AQ105			
MCFK1608			
MCFE1608			
MCKK1608			
MCHK2012			
MCKK2012			

► This catalog contains the typical specification only due to the limitation of space. When you consider the purchase of our products, please check our specification.  
For details of each product (characteristics graph, reliability information, precautions for use, and so on), see our Web site (<http://www.ty-top.com/>).

2. Storage Temperature Range

Specified Value	BK0402	-55~+125°C	
	BK0603		
	BK1005		
	BKH0603		
	BKH1005		
	BK1608		
	BK2125		
	ARRAY		BK2010
			BK3216
	BKP0402		-55~+85°C
	BKP0603		
	BKP1005		
	BKP1608		
	BKP2125		
	MCF 0605	-40~+85°C	
	MCF 0806		
	MCF 1210		
	MCF 2010		
	CK1608	-40~+85°C	
	CK2125		
	CKS2125		
	CKP1608		
	CKP2012		
	CKP2016		
	CKP2520		
	NM2012		
	NM2520		
	LK1005		
	LK1608		
	LK2125		
	HKQ0402		-55~+125°C
	HK0603		
	HK1005		
	HK1608	-40~+85°C	
HK2125			
HKQ0603W/HKQ0603S/HKQ0603U	-55~+125°C		
AQ105			
MCFK1608	-40~+85°C		
MCFE1608			
MCKK1608			
MCHK2012			
MCKK2012			

▶ This catalog contains the typical specification only due to the limitation of space. When you consider the purchase of our products, please check our specification.  
 For details of each product (characteristics graph, reliability information, precautions for use, and so on), see our Web site (<http://www.ty-top.com/>).

### 3. Rated Current

	BK0402	150~750mA DC
	BK0603	100~500mA DC
	BK1005	120~1000mA DC
	BKH0603	115~450mA DC
	BKH1005	200~300mA DC
	BK1608	150~1500mA DC
	BK2125	200~1200mA DC
	ARRAY	BK2010 100mA DC
		BK3216 100~200mA DC
	BKP0402	0.55~1.1A DC
	BKP0603	0.8~1.8A DC
	BKP1005	0.8~2.4A DC
	BKP1608	1.0~3.0A DC
	BKP2125	1.5~4.0A DC
	MCF 0605	0.05A DC
	MCF 0806	0.1~0.13A DC
	MCF 1210	0.1~0.16A DC
	MCF 2010	0.1A DC
	CK1608	50~60mA DC
	CK2125	60~500mA DC
	CKS2125	110~280mA DC
	CKP1608	0.35~0.9A DC
Specified Value	CKP2012	0.7~1.7A DC
	CKP2016	0.9~1.6A DC
	CKP2520	1.1~1.8A DC
	NM2012	1.0~1.2A DC
	NM2520	0.9~1.2A DC
	LK1005	20~25mA DC
	LK1608	1~150mA DC
	LK2125	5~300mA DC
	HK0603	60~470mA DC
	HK1005	110~300mA DC (-55~+125°C) 200~900mA DC (-55~+85°C)
	HK1608	150~300mA DC
	HK2125	300mA DC
	HKQ0402	100~500mA DC
	HKQ0603W	100~850mA DC
	HKQ0603S	130~600mA DC
	HKQ0603U	190~900mA DC
	AQ105	280~710mA DC
	MCFK1608	Idc1 : 1500~2300mA DC, Idc2 : 900~2100mA DC
	MCFE1608	Idc1 : 1400~2600mA DC, Idc2 : 800~1500mA DC
	MCKK1608	Idc1 : 2800~2000mA DC Idc2 : 1300~2600mA DC
	MCHK2012	Idc1 : 2260~4320mA DC, Idc2 : 1470~3600mA DC
	MCKK2012	Idc1 : 3600~6200mA DC, Idc2 : 2100~4000mA DC

#### Definition of rated current:

- In the CK, CKS and BK Series, the rated current is the value of current at which the temperature of the element is increased within 20°C.
- In the BK Series P type, CK Series P type, NM Series, the rated current is the value of current at which the temperature of the element is increased within 40°C.
- In the LK, HK, HKQ0603, and AQ Series, the rated current is either the DC value at which the initial L value is decreased within 5% with the application of DC bias, or the value of current at which the temperature of the element is increased within 20°C.
- In the HKQ0402(~9N1), the rated current is either the DC value at which the initial L value is decreased within 5% with the application of DC bias, or the value of current at which the temperature of the element is increased within 20°C.
- In the HKQ0402(10N~), the rated current is either the DC value at which the initial L value is decreased within 5% with the application of DC bias, or the value of current at which the temperature of the element is increased within 25°C.
- In the MC Series, Idc1 is the DC value at which the initial L value is decreased within 30% and Idc2 is the DC value at which the temperature of element is increased within 40°C by the application of DC bias. (at 20°C)

4. Impedance			
Specified Value	BK0402	10~330 Ω ±5 Ω(10 Ω), ±25%(Other)	
	BK0603	10~1200 Ω ±25%	
	BK1005	10~1800 Ω ±25%	
	BKH0603	25~1500 Ω ±25%	
	BKH1005	600~1800 Ω ±25%	
	BK1608	22~2500 Ω ±25%	
	BK2125	15~2500 Ω ±25%	
	ARRAY	BK2010	5~1000 Ω ±25%
		BK3216	60~1000 Ω ±25%
	BKP0402	10~33 Ω ±5 Ω(10 Ω), ±25%(Other)	
	BKP0603	10~120 Ω ±5 Ω(10 Ω), ±25%(Other)	
	BKP1005	10~330 Ω ±5 Ω(EM100), ±25%(Other)	
	BKP1608	33~470 Ω ±25%	
	BKP2125	33~330 Ω ±25%	
	MCF 0605	12~90 Ω ±5 Ω(12 Ω), ±20%(35 Ω90 Ω), ±25%(60 Ω)	
	MCF 0806	12~90 Ω ±5 Ω(12 Ω), ±20%(47 Ω90 Ω), ±25%(30 Ω)	
	MCF 1210	40~90 Ω ±20%(2H900), ±25%(Other)	
	MCF 2010	90 Ω ±25%	
	CK1608		
	CK2125		
	CKS2125		
	CKP1608		
	CKP2012		
	CKP2016		
	CKP2520		
	NM2012		
	NM2520		
	LK1005		
	LK1608		
	LK2125		
	HKQ0402		
	HK0603		
	HK1005		
	HK1608		
	HK2125		
	HKQ0603W/HKQ0603S/HKQ0603U		
	AQ105		
	MCFK1608		
	MCFE1608		
	MCKK1608		
	MCHK2012		
	MCKK2012		
	Test Methods and Remarks	BK0402Series, BKP0402Series Measuring frequency : 100±1MHz Measuring equipment : E4991A (or its equivalent) Measuring jig : 16197A (or its equivalent)	
BK0603Series, BKP0603Series Measuring frequency : 100±1MHz Measuring equipment : 4291A (or its equivalent) Measuring jig : 16193A (or its equivalent)			
BK1005Series, BKP1005Series, BKH1005Series Measuring frequency : 100±1MHz Measuring equipment : 4291A (or its equivalent) Measuring jig : 16192A (or its equivalent), 16193A (or its equivalent)			
BK1608・2125Series, BKP1608・2125Series Measuring frequency : 100±1MHz Measuring equipment : 4291A (or its equivalent), 4195A (or its equivalent) Measuring jig : 16092A (or its equivalent) or 16192A (or its equivalent) /HW			
BK2010・3216Series, MCF Series Measuring frequency : 100±1MHz Measuring equipment : 4291A (or its equivalent), 4195A (or its equivalent) Measuring jig : 16192A (or its equivalent)			

▶ This catalog contains the typical specification only due to the limitation of space. When you consider the purchase of our products, please check our specification. For details of each product (characteristics graph, reliability information, precautions for use, and so on), see our Web site (<http://www.ty-top.com/>).

5. Inductance

Specified Value	BK0402		
	BK0603		
	BK1005		
	BKH0603		
	BKH1005		
	BK1608		
	BK2125		
	ARRAY	BK2010	
		BK3216	
	BKP0402		
	BKP0603		
	BKP1005		
	BKP1608		
	BKP2125		
	MCF 0605		
	MCF 0806		
	MCF 1210		
	MCF 2010		
	CK1608	4.7~10.0 $\mu$ H: $\pm$ 20%	
	CK2125	0.1~10.0 $\mu$ H: $\pm$ 20%	
	CKS2125	1.0~10.0 $\mu$ H: $\pm$ 20%	
	CKP1608	0.33~2.2 $\mu$ H: $\pm$ 20%	
	CKP2012	0.47~4.7 $\mu$ H: $\pm$ 20%	
	CKP2016	0.47~4.7 $\mu$ H: $\pm$ 20%	
	CKP2520	0.47~4.7 $\mu$ H: $\pm$ 20%	
	NM2012	0.82~1.0 $\mu$ H: $\pm$ 20%	
NM2520	1.0~2.2 $\mu$ H: $\pm$ 20%		
LK1005	0.12~2.2 $\mu$ H: $\pm$ 10 or 20%		
LK1608	0.047~33.0 $\mu$ H: $\pm$ 20% 0.10~12.0 $\mu$ H: $\pm$ 10%		
LK2125	0.047~33.0 $\mu$ H: $\pm$ 20% 0.10~12.0 $\mu$ H: $\pm$ 10%		
HK0603	1.0~6.2nH: $\pm$ 0.3nH 6.8~100nH: $\pm$ 5%		
HK1005	1.0~6.2nH: $\pm$ 0.3nH 6.8~270nH: $\pm$ 5%		
HK1608	1.0~5.6nH: $\pm$ 0.3nH 6.8~470nH: $\pm$ 5%		
HK2125	1.5~5.6nH: $\pm$ 0.3nH 6.8~470nH: $\pm$ 5%		
HKQ0402	0.5~3.9nH: $\pm$ 0.1 or 0.2 or 0.3nH 4.3~5.6nH: $\pm$ 0.3nH or 3% or 5% 6.2~47nH: $\pm$ 3 or 5%		
HKQ0603W	0.6~3.9nH: $\pm$ 0.1 or 0.2 or 0.3nH 4.3~6.2nH: $\pm$ 0.2 or 0.3nH or 3 or 5% 6.8~30nH: $\pm$ 3 or 5% 33~100nH: $\pm$ 5%		
HKQ0603S	0.6~6.2nH: $\pm$ 0.2 or 0.3nH 6.8~22nH: $\pm$ 3 or 5%		
HKQ0603U	0.6~4.2nH: $\pm$ 0.1 or 0.2 or 0.3nH 4.3~6.5nH: $\pm$ 0.2 or 0.3nH 6.8~22nH: $\pm$ 3 or 5%		
AQ105	1.0~6.2nH: $\pm$ 0.3nH 6.8~15nH: $\pm$ 5%		
MCFK1608	0.24~1.0 $\mu$ H: $\pm$ 20%		
MCFE1608	0.24~1.0 $\mu$ H: $\pm$ 20%		
MCKK1608	0.24~1.0 $\mu$ H: $\pm$ 20%		
MCHK2012	0.24~1.0 $\mu$ H: $\pm$ 20%		
MCKK2012	0.24~1.0 $\mu$ H: $\pm$ 20%		
Test Methods and Remarks	CK, LK, CKP, NM, MC Series		
	Measuring frequency	: 2~4MHz (CK1608) : 2~25MHz (CK2125) : 2~10MHz (CKS2125) : 10~25MHz (LK1005) : 1~50MHz (LK1608) : 0.4~50MHz (LK2125) : 1MHz (CKP1608·CKP2012·CKP2016·CKP2520·NM2012·NM2520·MCFK1608·MCFE1608·MCHK2012·MCKK2012) Measuring equipment /jig : 4194A + 16085B + 16092A (or its equivalent) 4195A + 41951 + 16092A (or its equivalent) 4294A + 16192A (or its equivalent) 4291A + 16193A (or its equivalent) /LK1005 4285A + 42841A + 42842C + 42851 - 61100 (or its equivalent) /CKP1608·CKP2012·CKP2016·CKP2520·NM2012·NM2520·MCFK1608·MCFE1608·MCKK1608·MCHK2012·MCKK2012	
Test Methods and Remarks	Measuring current	: 1mA rms (0.047~4.7 $\mu$ H) : 0.1mA rms (5.6~33 $\mu$ H)	
	HK, HKQ, AQ Series		
Test Methods and Remarks	Measuring frequency	: 100MHz (HK0603·HK1005·AQ105) : 50/100MHz (HK1608·HK2125) : 500MHz (HKQ0603S·HKQ0603U) : 300/500MHz (HKQ0603W) : 100/500MHz (HKQ0402) Measuring equipment /jig : 4291A + 16197A (or its equivalent) /HK0603·AQ105 4291A + 16193A (or its equivalent) /HK1005 E4991A + 16197A (or its equivalent) /HKQ0603S·HKQ0603U·HKQ0603W 4291A + 16092A + in-house made jig (or its equivalent) /HK1608·HK2125 E4991A + 16196D (or its equivalent) /HKQ0402	

▶ This catalog contains the typical specification only due to the limitation of space. When you consider the purchase of our products, please check our specification.  
For details of each product (characteristics graph, reliability information, precautions for use, and so on), see our Web site (<http://www.ty-top.com/>).

Specified Value	BK0402	—	
	BK0603		
	BK1005		
	BKH0603		
	BKH1005		
	BK1608		
	BK2125		
	ARRAY		BK2010
			BK3216
	BKP0402		
	BKP0603		
	BKP1005		
	BKP1608		
	BKP2125		
	MCF 0605		
	MCF 0806		
	MCF 1210		
	MCF 2010		
	CK1608		—
	CK2125		
	CKS2125		
	CKP1608		
	CKP2012		
	CKP2016		
	CKP2520		
	NM2012		
NM2520			
LK1005	10~20 min.		
LK1608	10~35 min.		
LK2125	15~50 min.		
HK0603	4~5 min.		
HK1005	8 min.		
HK1608	8~12 min.		
HK2125	10~18 min.		
HKQ0402	3~8 min.		
HKQ0603W	6~15 min.		
HKQ0603S	10~13 min.		
HKQ0603U	14 min.		
AQ105	8 min.		
MCFK1608	—		
MCFE1608			
MCKK1608			
MCHK2012			
MCKK2012			
Test Methods and Remarks	LK Series		
	Measuring frequency	: 10~25MHz (LK1005)	
	Measuring frequency	: 1~50MHz (LK1608)	
	Measuring frequency	: 0.4~50MHz (LK2125)	
	Measuring equipment /jig	· 4194A + 16085B + 16092A (or its equivalent) · 4195A + 41951 + 16092A (or its equivalent) · 4294A + 16192A (or its equivalent) · 4291A + 16193A (or its equivalent) / LK1005	
	Measuring current	· 1mA rms (0.047~4.7 μH) · 0.1mA rms (5.6~33 μH)	
	HK, HKQ, AQ Series		
	Measuring frequency	: 100MHz (HK0603·HK1005·AQ105)	
	Measuring frequency	: 50/100MHz (HK1608·HK2125)	
	Measuring frequency	: 500MHz (HKQ0603S·HKQ0603U)	
	Measuring frequency	: 300/500MHz (HKQ0603W)	
	Measuring frequency	: 100/500MHz (HKQ0402)	
	Measuring equipment /jig	· 4291A + 16197A (or its equivalent) / HK0603·AQ105 · 4291A + 16193A (or its equivalent) / HK1005 · E4991A + 16197A (or its equivalent) / HKQ0603S·HKQ0603U·HKQ0603W · 4291A + 16092A + in-house made jig (or its equivalent) / HK1608, HK2125 · E4991A + 16196D (or its equivalent) / HKQ0402	

7. DC Resistance			
Specified Value	BK0402	0.07~1.2 Ω max.	
	BK0603	0.065~1.50 Ω max.	
	BK1005	0.03~0.90 Ω max.	
	BKH0603	0.26~3.20 Ω max.	
	BKH1005	0.85~2.00 Ω max.	
	BK1608	0.05~1.10 Ω max.	
	BK2125	0.05~0.75 Ω max.	
	ARRAY	BK2010	0.10~0.90 Ω max.
		BK3216	0.15~0.80 Ω max.
	BKP0402	0.05~0.15 Ω max.	
	BKP0603	0.030~0.180 Ω max.	
	BKP1005	0.0273~0.220 Ω max.	
	BKP1608	0.025~0.18 Ω max.	
	BKP2125	0.020~0.075 Ω max.	
	MCF 0605	2.5~5.0 Ω max	
	MCF 0806	1.5~5.0 Ω max.	
	MCF 1210	1.5~4.5 Ω max.	
	MCF 2010	4.5 Ω max.	
	CK1608	0.45~0.85 Ω(±30%)	
	CK2125	0.16~0.65 Ω max.	
	CKS2125	0.12~0.52 Ω max.	
	CKP1608	0.15~0.35 Ω max.	
	CKP2012	0.08~0.28 Ω max.	
	CKP2016	0.075~0.20 Ω max	
	CKP2520	0.05~0.16 Ω max.	
	NM2012	0.10~0.15 Ω max.	
	NM2520	0.11~0.22 Ω max.	
	LK1005	0.41~1.16 Ω max.	
	LK1608	0.2~2.2 Ω max.	
	LK2125	0.1~1.1 Ω max.	
	HK0603	0.11~3.74 Ω max.	
	HK1005	0.08~4.8 Ω max.	
	HK1608	0.05~2.6 Ω max.	
	HK2125	0.10~1.5 Ω max.	
	HKQ0402	0.08~5.0 Ω max.	
	HKQ0603W	0.07~4.1 Ω max.	
	HKQ0603S	0.06~1.29 Ω max.	
	HKQ0603U	0.06~1.29 Ω max.	
	AQ105	0.07~0.45 Ω max.	
	MCFK1608	0.050~0.224 Ω max.	
	MCFE1608	0.100~0.340 Ω max.	
	MCKK1608	0.038~0.123 Ω max.	
	MCHK2012	0.024~0.111 Ω max.	
	MCKK2012	0.025~0.090 Ω max.	
	Test Methods and Remarks	Measuring equipment: VOAC-7412, VOAC-7512, VOAC-7521 (made by Iwasaki Tsushinki), HIOKI3227 (or its equivalent)	

8. Self Resonance Frequency (SRF)

Specified Value	BK0402	
	BK0603	
	BK1005	
	BKH0603	
	BKH1005	
	BK1608	
	BK2125	
	ARRAY	BK2010
		BK3216
	BKP0402	—
	BKP0603	
	BKP1005	
	BKP1608	
	BKP2125	
	MCF 0605	
	MCF 0806	
	MCF 1210	
	MCF 2010	
	CK1608	17~25MHz min.
	CK2125	24~235MHz min.
	CKS2125	24~75MHz min.
	CKP1608	
	CKP2012	—
	CKP2016	
	CKP2520	
	NM2012	
	NM2520	
	LK1005	40~180MHz min.
	LK1608	9~260MHz min.
	LK2125	13~320MHz min.
	HK0603	900~10000MHz min.
	HK1005	400~10000MHz min.
	HK1608	300~10000MHz min.
HK2125	200~4000MHz min.	
HKQ0402	1200~10000MHz min.	
HKQ0603W	800~10000MHz min.	
HKQ0603S	1900~10000MHz min.	
HKQ0603U	1900~10000MHz min.	
AQ105	2300~10000MHz min.	
MCFK1608		
MCFE1608		
MCKK1608	—	
MCHK2012		
MCKK2012		
Test Methods and Remarks	LK, CK Series : Measuring equipment : 4195A (or its equivalent) Measuring jig : 41951 + 16092A (or its equivalent) HK, HKQ, AQ Series : Measuring equipment : 8719C (or its equivalent) • 8753D (or its equivalent) / HK2125	



9. Temperature Characteristic

Specified Value	BK0402	-	
	BK0603		
	BK1005		
	BKH0603		
	BKH1005		
	BK1608		
	BK2125		
	ARRAY		BK2010
			BK3216
	BKP0402		
	BKP0603		
	BKP1005		
	BKP1608		
	BKP2125		
	MCF 0605		
	MCF 0806		
	MCF 1210		
	MCF 2010		
	CK1608		
	CK2125		
	CKS2125		
	CKP1608		
	CKP2012		
	CKP2016		
	CKP2520		
	NM2012		
	NM2520		
	LK1005		
	LK1608		
	LK2125		
	HK0603		Inductance change: Within $\pm 10\%$
	HK1005		
	HK1608		
	HK2125		
	HKQ0402		
HKQ0603W			
HKQ0603S			
HKQ0603U			
AQ105			
MCFK1608			
MCFE1608			
MCKK1608			
MCHK2012			
MCKK2012			
Test Methods and Remarks	HK, HKQ, AQ Series: Temperature range : $-30 \sim +85^{\circ}\text{C}$ Reference temperature : $+20^{\circ}\text{C}$ MC Series: Temperature range : $-40 \sim +85^{\circ}\text{C}$ Reference temperature : $+20^{\circ}\text{C}$		

10. Resistance to Flexure of Substrate

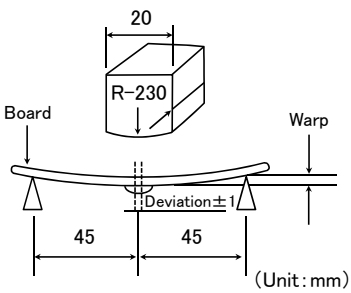
Specified Value	BK0402	No mechanical damage.	
	BK0603		
	BK1005		
	BKH0603		
	BKH1005		
	BK1608		
	BK2125		
	ARRAY		BK2010
			BK3216
	BKP0402		
	BKP0603		
	BKP1005		
	BKP1608		
	BKP2125		
	MCF 0605		
	MCF 0806		
	MCF 1210		
	MCF 2010		
	CK1608		
	CK2125		
	CKS2125		
	CKP1608		
	CKP2012		
	CKP2016		
	CKP2520		
	NM2012		
	NM2520		
	LK1005		
	LK1608		
	LK2125		
	HK0603		
	HK1005		
	HK1608		
	HK2125		
	HKQ0402		
HKQ0603W			
HKQ0603S			
HKQ0603U			
AQ105			
MCFK1608			
MCFE1608			
MCKK1608			
MCHK2012			
MCKK2012			
Test Methods and Remarks	<p>Warp : 2mm (BK Series without 0402size, BKP, BKH1005, CK, CKS, CKP, LK, HK, HKQ0603S, HKQ0603U, AQ Series, MCF1210, MC Series)  : 1mm (BK0402, BKP0402, BKH0603, HKQ0402, HKQ0603W, MCF Series without 1210 size.)</p> <p>Testing board : glass epoxy-resin substrate  Thickness : 0.8mm</p>  <p>(Unit: mm)</p>		

▶ This catalog contains the typical specification only due to the limitation of space. When you consider the purchase of our products, please check our specification. For details of each product (characteristics graph, reliability information, precautions for use, and so on), see our Web site (<http://www.ty-top.com/>).

11. Solderability

Specified Value	BK0402	At least 90% of terminal electrode is covered by new solder.	
	BK0603		
	BK1005		
	BKH0603		
	BKH1005		
	BK1608		
	BK2125		
	ARRAY		BK2010
			BK3216
	BKP0402		
	BKP0603		
	BKP1005		
	BKP1608		
	BKP2125		
	MCF 0605		
	MCF 0806		
	MCF 1210		
	MCF 2010		
	CK1608		
	CK2125		
	CKS2125		
	CKP1608		
	CKP2012		
	CKP2016		
	CKP2520		
	NM2012		
	NM2520		
	LK1005		
	LK1608		
	LK2125		
	HK0603		
	HK1005		
	HK1608		
	HK2125		
HKQ0402			
HKQ0603W			
HKQ0603S			
HKQ0603U			
AQ105			
MCFK1608			
MCFE1608			
MCKK1608			
MCHK2012			
MCKK2012			
Test Methods and Remarks	Solder temperature : 230±5°C (JIS Z 3282 H60A or H63A)		
	Solder temperature : 245±3°C (Sn/3.0Ag/0.5Cu)		
	Duration : 4±1 sec.		

► This catalog contains the typical specification only due to the limitation of space. When you consider the purchase of our products, please check our specification.  
 For details of each product (characteristics graph, reliability information, precautions for use, and so on), see our Web site (<http://www.ty-top.com/>).

12. Resistance to Soldering

Specified Value	BK0402	Appearance: No significant abnormality Impedance change: Within $\pm 30\%$	
	BK0603		
	BK1005		
	BKH0603		
	BKH1005		
	BK1608		
	BK2125		
	ARRAY		BK2010
			BK3216
	BKP0402		
	BKP0603		
	BKP1005		
	BKP1608		
	BKP2125		
	MCF 0605		Appearance: No significant abnormality Impedance change: Within $\pm 20\%$
	MCF 0806		
	MCF 1210		
	MCF 2010		
	CK1608	Appearance: No significant abnormality Inductance change R10~4R7: Within $\pm 10\%$ 6R8~100: Within $\pm 15\%$ CKS2125 : Within $\pm 20\%$ CKP1608, CKP2012, CKP2016, CKP2520, NM2012, NM2520: Within $\pm 30\%$	
	CK2125		
	CKS2125		
	CKP1608		
	CKP2012		
	CKP2016		
	CKP2520		
	NM2012		
	NM2520		
LK1005	Appearance: No significant abnormality Inductance change: Within $\pm 15\%$		
LK1608	Appearance: No significant abnormality Inductance change		
LK2125	47N~4R7: Within $\pm 10\%$ 5R6~330: Within $\pm 15\%$		
HK0603	Appearance: No significant abnormality Inductance change: Within $\pm 5\%$		
HK1005			
HK1608			
HK2125			
HKQ0402			
HKQ0603W			
HKQ0603S			
HKQ0603U			
AQ105			
MCFK1608			
MCFE1608	Appearance: No significant abnormality Inductance change: Within $\pm 10\%$		
MCKK1608			
MCHK2012			
MCKK2012			
Test Methods and Remarks	Solder temperature : $260 \pm 5^\circ\text{C}$ Duration : $10 \pm 0.5$ sec. Preheating temperature : $150$ to $180^\circ\text{C}$ Preheating time : 3 min. Flux : Immersion into methanol solution with colophony for 3 to 5 sec. Recovery : 2 to 3 hrs of recovery under the standard condition after the test. (See Note 1)		

(Note 1) When there are questions concerning measurement result; measurement shall be made after  $48 \pm 2$  hrs of recovery under the standard condition.

13. Thermal Shock

Specified Value	BK0402	Appearance: No significant abnormality Impedance change: Within $\pm 30\%$	
	BK0603		
	BK1005		
	BKH0603		
	BKH1005		
	BK1608		
	BK2125		
	ARRAY		BK2010 BK3216
	BKP0402		
	BKP0603		
	BKP1005		
	BKP1608		
	BKP2125		
	MCF 0605		
	MCF 0806		Appearance: No significant abnormality Impedance change: Within $\pm 20\%$
	MCF 1210		
	MCF 2010		
	CK1608		
	CK2125		Appearance: No significant abnormality Inductance change: Within $\pm 20\%$ Q change: Within $\pm 30\%$
	CKS2125		
	CKP1608		Appearance: No significant abnormality Inductance change: Within $\pm 30\%$
	CKP2012		
	CKP2016		
	CKP2520		
	NM2012		
NM2520			
LK1005	Appearance: No significant abnormality Inductance change: Within $\pm 10\%$ Q change: Within $\pm 30\%$		
LK1608			
LK2125			
HK0603	Appearance: No significant abnormality Inductance change: Within $\pm 10\%$ Q change: Within $\pm 20\%$		
HK1005			
HK1608			
HK2125			
HKQ0402			
HKQ0603W			
HKQ0603S			
HKQ0603U			
AQ105			
MCFK1608			
MCFE1608	Appearance: No significant abnormality Inductance change: Within $\pm 10\%$		
MCKK1608			
MCHK2012			
MCKK2012			
Test Methods and Remarks	Conditions for 1 cycle		
	Step	temperature (°C)	time (min.)
	1	Minimum operating temperature $+0/-3$	$30 \pm 3$
	2	Room temperature	$2 \sim 3$
	3	Maximum operating temperature $+3/-0$	$30 \pm 3$
4	Room temperature	$2 \sim 3$	
	Number of cycles: 5		
	Recovery: 2 to 3 hrs of recovery under the standard condition after the test. (See Note 1)		
(Note 1) When there are questions concerning measurement result; measurement shall be made after $48 \pm 2$ hrs of recovery under the standard condition.			

14. Damp Heat ( Steady state)			
Specified Value	BK0402	Appearance: No significant abnormality Impedance change: Within $\pm 30\%$	
	BK0603		
	BK1005		
	BKH0603		
	BKH1005		
	BK1608		
	BK2125		
	ARRAY		BK2010
			BK3216
	BKP0402		
	BKP0603		
	BKP1005		
	BKP1608		
	BKP2125		
	MCF 0605		Appearance: No significant abnormality Impedance change: Within $\pm 20\%$
	MCF 0806		
	MCF 1210		
	MCF 2010		
	CK1608	Appearance: No significant abnormality Inductance change: Within $\pm 20\%$ Q change: Within $\pm 30\%$	
	CK2125		
	CKS2125	Appearance: No significant abnormality Inductance change: Within $\pm 20\%$	
	CKP1608		
	CKP2012	Appearance: No significant abnormality Inductance change: Within $\pm 30\%$	
	CKP2016		
	CKP2520		
	NM2012		
	NM2520		
	LK1005		
	LK1608	Appearance: No significant abnormality Inductance change: Within $\pm 10\%$ Q change: Within $\pm 30\%$	
	LK2125		
	HK0603	Appearance: No significant abnormality Inductance change: Within $\pm 20\%$ Q change: Within $\pm 30\%$	
	HK1005		
HK1608			
HK2125			
HKQ0402			
HKQ0603W			
HKQ0603S			
HKQ0603U			
AQ105			
MCFK1608			
MCFE1608	Appearance: No significant abnormality Inductance change: Within $\pm 10\%$		
MCKK1608			
MCHK2012			
MCKK2012			
Test Methods and Remarks	BK, BKP, BKH, LK, CK, CKS, CKP, NM Series, MCF Series: Temperature : $40 \pm 2^{\circ}\text{C}$ Humidity : 90 to 95%RH Duration : 500 +24/-0 hrs Recovery : 2 to 3 hrs of recovery under the standard condition after the removal from test chamber. (See Note 1)  HK, HKQ, AQ, MC Series: Temperature : $60 \pm 2^{\circ}\text{C}$ Humidity : 90 to 95%RH Duration : 500 +24/-0 hrs Recovery : 2 to 3 hrs of recovery under the standard condition after the removal from test chamber. (See Note 1)		
(Note 1) When there are questions concerning measurement result; measurement shall be made after $48 \pm 2$ hrs of recovery under the standard condition.			

15. Loading under Damp Heat

Specified Value	BK0402	Appearance: No significant abnormality Impedance change: Within $\pm 30\%$	
	BK0603		
	BK1005		
	BKH0603		
	BKH1005		
	BK1608		
	BK2125		
	ARRAY		BK2010
			BK3216
	BKP0402		
	BKP0603		
	BKP1005		
	BKP1608		
	BKP2125		
	CK1608	Appearance: No significant abnormality	
	CK2125	Inductance change: Within $\pm 20\%$ Q change: Within $\pm 30\%$	
	CKS2125	Appearance: No significant abnormality Inductance change: Within $\pm 20\%$	
	CKP1608	Appearance: No significant abnormality Inductance change: Within $\pm 30\%$	
	CKP2012		
	CKP2016		
	CKP2520		
	NM2012		
	NM2520		
	LK1005	Appearance: No significant abnormality Inductance change: Within $\pm 10\%$ Q change: Within $\pm 30\%$	
	LK1608	Appearance: No significant abnormality Inductance change: 0.047~12.0 $\mu\text{H}$ : Within $\pm 10\%$ 15.0~33.0 $\mu\text{H}$ : Within $\pm 15\%$ Q change: Within $\pm 30\%$	
	LK2125	Appearance: No significant abnormality Inductance change: Within $\pm 20\%$ Q change: Within $\pm 30\%$	
	HK0603	Appearance: No significant abnormality Inductance change: Within $\pm 10\%$ Q change: Within $\pm 20\%$	
	HK1005		
	HK1608		
	HK2125		
	HKQ0402		
	HKQ0603W		
HKQ0603S			
HKQ0603U			
AQ105			
MCFK1608※	Appearance: No significant abnormality Inductance change: Within $\pm 10\%$		
MCFE1608※			
MCKK1608※			
MCHK2012※			
MCKK2012※			
Test Methods and Remarks	<p>BK、BKP、BKH、LK、CK、CKS、CKP、NM Series:</p> <p>Temperature : <math>40 \pm 2^\circ\text{C}</math>  Humidity : 90 to 95%RH  Applied current : Rated current  Duration : 500 +24/-0 hrs  Recovery : 2 to 3 hrs of recovery under the standard condition after the removal from test chamber. (See Note 1)</p> <p>HK、HKQ、AQ、MC Series:</p> <p>Temperature : <math>60 \pm 2^\circ\text{C}</math>  Humidity : 90 to 95%RH  Applied current : Rated current ※MC series ; <math>I_{dc2max}</math>  Duration : 500 +24/-0 hrs  Recovery : 2 to 3 hrs of recovery under the standard condition after the removal from test chamber. (See Note 1)</p>		

Note on standard condition: "standard condition" referred to herein is defined as follows:

5 to 35°C of temperature, 45 to 85% relative humidity, and 86 to 106kPa of air pressure.

When there are questions concerning measurement results:

In order to provide correlation data, the test shall be conducted under condition of  $20 \pm 2^\circ\text{C}$  of temperature, 60 to 70% relative humidity, and 86 to 106kPa of air pressure.

Unless otherwise specified, all the tests are conducted under the "standard condition."

(Note 1) Measurement shall be made after  $48 \pm 2$  hrs of recovery under the standard condition.

16. Loading at High Temperature

Specified Value	BK0402	Appearance: No significant abnormality Impedance change: Within $\pm 30\%$	
	BK0603		
	BK1005		
	BKH0603		
	BKH1005		
	BK1608		
	BK2125		
	ARRAY		BK2010
			BK3216
	BKP0402		
	BKP0603		
	BKP1005		
	BKP1608		
	BKP2125		
	MCF 0605		Appearance: No significant abnormality Impedance change: Within $\pm 20\%$
	MCF 0806		
	MCF 1210		
	MCF 2010		
	CK1608	Appearance: No significant abnormality Inductance change: Within $\pm 20\%$ Q change: Within $\pm 30\%$	
	CK2125		
	CKS2125	Appearance: No significant abnormality Inductance change: Within $\pm 20\%$	
	CKP1608		
	CKP2012	Appearance: No significant abnormality Inductance change: Within $\pm 30\%$	
	CKP2016		
	CKP2520		
	NM2012		
	NM2520		
	LK1005	Appearance: No significant abnormality Inductance change: Within $\pm 10\%$ Q change: Within $\pm 30\%$	
	LK1608		
	LK2125	Appearance: No significant abnormality Inductance change: Within $\pm 20\%$ Q change: Within $\pm 30\%$	
	HK0603		
	HK1005		
	HK1608		
	HK2125		
	HKQ0402	Appearance: No significant abnormality Inductance change: Within $\pm 10\%$ Q change: Within $\pm 20\%$	
HKQ0603W			
HKQ0603S			
HKQ0603U			
AQ105			
MCFK1608※			
MCFE1608※			
MCKK1608※			
MCHK2012※	Appearance: No significant abnormality Inductance change: Within $\pm 10\%$		
MCKK2012※			
Test Methods and Remarks	Temperature : Maximum operating temperature Applied current : Rated current ※MC series ; I <sub>dc2max</sub> Duration : 500 +24/-0 hrs Recovery : 2 to 3 hrs of recovery under the standard condition after the removal from test chamber. (See Note 1)		

Note on standard condition: "standard condition" referred to herein is defined as follows:  
5 to 35°C of temperature, 45 to 85% relative humidity, and 86 to 106kPa of air pressure.

When there are questions concerning measurement results:

In order to provide correlation data, the test shall be conducted under condition of 20 $\pm$ 2°C of temperature, 60 to 70% relative humidity, and 86 to 106kPa of air pressure. Unless otherwise specified, all the tests are conducted under the "standard condition."

(Note 1) Measurement shall be made after 48 $\pm$ 2 hrs of recovery under the standard condition.



# Precautions on the use of Multilayer chip inductors

## Multilayer chip inductors for high frequency, Multilayer chip bead inductors

## Multilayer common mode choke coils (MC series F type)

## Metal Multilayer Chip Power Inductors (MCOIL™ MC series)

### PRECAUTIONS

#### 1. Circuit Design

- Precautions**
- ◆ Verification of operating environment, electrical rating and performance
    1. A malfunction in medical equipment, spacecraft, nuclear reactors, etc. may cause serious harm to human life or have severe social ramifications. As such, any inductors to be used in such equipment may require higher safety and/or reliability considerations and should be clearly differentiated from components used in general purpose applications.
  - ◆ Operating Current (Verification of Rated current)
    1. The operating current including inrush current for inductors must always be lower than their rated values.
    2. Do not apply current in excess of the rated value because the inductance may be reduced due to the magnetic saturation effect.

#### 2. PCB Design

- Precautions**
- ◆ Pattern configurations (Design of Land-patterns)
    1. When inductors are mounted on a PCB, the size of land patterns and the amount of solder used (size of fillet) can directly affect inductor performance. Therefore, the following items must be carefully considered in the design of solder land patterns:
      - (1) The amount of solder applied can affect the ability of chips to withstand mechanical stresses which may lead to breaking or cracking. Therefore, when designing land-patterns it is necessary to consider the appropriate size and configuration of the solder pads which in turn determines the amount of solder necessary to form the fillets.
      - (2) When more than one part is jointly soldered onto the same land or pad, the pad must be designed so that each component's soldering point is separated by solder-resist.
      - (3) The larger size of land patterns and amount of solder, the smaller Q value after mounting on PCB. It makes higher the Q value to design land patterns smaller than terminal electrode of chips.
  - ◆ Pattern configurations (Inductor layout on panelized [breakaway] PC boards)
    1. After inductors have been mounted on the boards, chips can be subjected to mechanical stresses in subsequent manufacturing processes (PCB cutting, board inspection, mounting of additional parts, assembly into the chassis, wave soldering the reflow soldered boards etc.) For this reason, planning pattern configurations and the position of SMD inductors should be carefully performed to minimize stress.

- Technical considerations**
- ◆ Pattern configurations (Design of Land-patterns)
    1. The following diagrams and tables show some examples of recommended patterns to prevent excessive solder amounts (larger fillets which extend above the component end terminations). Examples of improper pattern designs are also shown.
      - (1) Recommended land dimensions for a typical chip inductor land patterns for PCBs

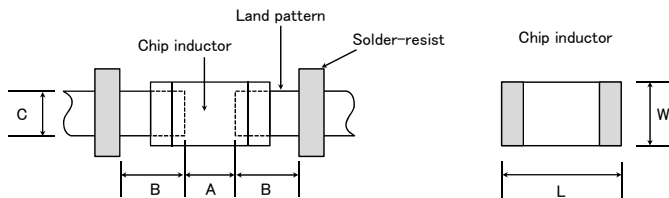

Recommended land dimensions for wave-soldering (Unit: mm)

Type	1608	2012	2125	2016	2520	3216	
Size	L	1.6	2.0	2.0	2.0	2.5	3.2
	W	0.8	1.25	1.25	1.6	2.0	1.6
A	0.8~1.0	1.0~1.4	1.0~1.4	1.0~1.4	1.0~1.4	1.8~2.5	
B	0.5~0.8	0.8~1.5	0.8~1.5	0.8~1.5	0.6~1.0	0.8~1.7	
C	0.6~0.8	0.9~1.2	0.9~1.2	1.3~1.6	1.6~2.0	1.2~1.6	

Recommended land dimensions for reflow-soldering (Unit: mm)

Type	0402	0603	1005	105	1608	2012	2125	2016	2520	3216
Size	L	0.4	0.6	1.0	1.0	1.6	2.0	2.0	2.5	3.2
	W	0.2	0.3	0.5	0.6	0.8	1.25	1.25	1.6	2.0
A	0.15~0.25	0.20~0.30	0.45~0.55	0.50~0.55	0.8~1.0	0.8~1.2	0.8~1.2	0.8~1.2	1.0~1.4	1.8~2.5
B	0.10~0.20	0.20~0.30	0.40~0.50	0.30~0.40	0.6~0.8	0.8~1.2	0.8~1.2	0.8~1.2	0.6~1.0	0.6~1.5
C	0.15~0.30	0.25~0.40	0.45~0.55	0.60~0.70	0.6~0.8	0.9~1.6	0.9~1.6	1.2~2.0	1.8~2.2	1.2~2.0

▶ This catalog contains the typical specification only due to the limitation of space. When you consider the purchase of our products, please check our specification. For details of each product (characteristics graph, reliability information, precautions for use, and so on), see our Web site (<http://www.ty-top.com/>).

Excess solder can affect the ability of chips to withstand mechanical stresses. Therefore, please take proper precautions when designing land-patterns.

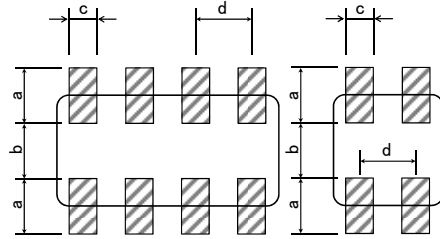

Recommended land dimension for Reflow-soldering

Type	3216	2010	1210	0806	0605	
Size	L	3.2	2.0	1.25	0.85	0.65
	W	1.6	1.0	1.0	0.65	0.50
a	0.7~0.9	0.5~0.6	0.45~0.55	0.25~0.35	0.27~0.33	
b	0.8~1.0	0.5~0.6	0.7~0.8	0.25~0.35	0.17~0.23	
c	0.4~0.5	0.2~0.3	0.25~0.35	0.25~0.35	0.20~0.26	
d	0.8	0.5	0.55	0.5	0.4	

(Unit: mm)

(2) Examples of good and bad solder application

Item	Not recommended	Recommended
Mixed mounting of SMD and leaded components		
Component placement close to the chassis		
Hand-soldering of leaded components near mounted components		
Horizontal component placement		

◆ Pattern configurations (Inductor layout on panelized [breakaway] PC boards)

1-1. The following are examples of good and bad inductor layout; SMD inductors should be located to minimize any possible mechanical stresses from board warp or deflection.

Item	Not recommended	Recommended
Deflection of the board		 Position the component at a right angle to the direction of the mechanical stresses that are anticipated.

1-2. To layout the inductors for the breakaway PC board, it should be noted that the amount of mechanical stresses given will vary depending on inductor layout.

An example below should be counted for better design.

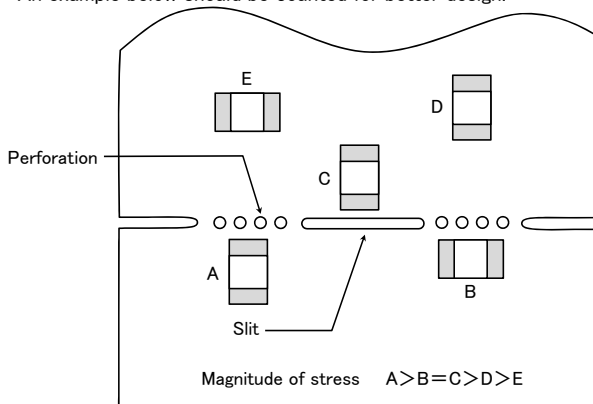

1-3. When breaking PC boards along their perforations, the amount of mechanical stress on the inductors can vary according to the method used. The following methods are listed in order from least stressful to most stressful: push-back, slit, V-grooving, and perforation. Thus, any ideal SMD inductor layout must also consider the PCB splitting procedure.

### 3. Considerations for automatic placement

#### Precautions

- ◆ Adjustment of mounting machine
  1. Excessive impact load should not be imposed on the inductors when mounting onto the PC boards.
  2. The maintenance and inspection of the mounter should be conducted periodically.
- ◆ Selection of Adhesives
  1. Mounting inductors with adhesives in preliminary assembly, before the soldering stage, may lead to degraded inductor characteristics unless the following factors are appropriately checked; the size of land patterns, type of adhesive, amount applied, hardening temperature and hardening period. Therefore, it is imperative to consult the manufacturer of the adhesives on proper usage and amounts of adhesive to use.

#### Technical considerations

- ◆ Adjustment of mounting machine
  1. If the lower limit of the pick-up nozzle is low, too much force may be imposed on the inductors, causing damage. To avoid this, the following points should be considered before lowering the pick-up nozzle:
    - (1) The lower limit of the pick-up nozzle should be adjusted to the surface level of the PC board after correcting for deflection of the board.
    - (2) The pick-up pressure should be adjusted between 1 and 3N static loads.
    - (3) To reduce the amount of deflection of the board caused by impact of the pick-up nozzle, supporting pins or back-up pins should be used under the PC board. The following diagrams show some typical examples of good pick-up nozzle placement:

Item	Improper method	Proper method
Single-sided mounting		
Double-sided mounting		

2. As the alignment pin wears out, adjustment of the nozzle height can cause chipping or cracking of the inductors because of mechanical impact on the inductors. To avoid this, the monitoring of the width between the alignment pin in the stopped position, and maintenance, inspection and replacement of the pin should be conducted periodically.
- ◆ Selection of Adhesives
    1. Some adhesives may cause reduced insulation resistance. The difference between the shrinkage percentage of the adhesive and that of the inductors may result in stresses on the inductors and lead to cracking. Moreover, too little or too much adhesive applied to the board may adversely affect component placement, so the following precautions should be noted in the application of adhesives.
      - (1) Required adhesive characteristics
        - a. The adhesive should be strong enough to hold parts on the board during the mounting & solder process.
        - b. The adhesive should have sufficient strength at high temperatures.
        - c. The adhesive should have good coating and thickness consistency.
        - d. The adhesive should be used during its prescribed shelf life.
        - e. The adhesive should harden rapidly.
        - f. The adhesive must not be contaminated.
        - g. The adhesive should have excellent insulation characteristics.
        - h. The adhesive should not be toxic and have no emission of toxic gasses.
      - (2) When using adhesives to mount inductors on a PCB, inappropriate amounts of adhesive on the board may adversely affect component placement. Too little adhesive may cause the inductors to fall off the board during the solder process. Too much adhesive may cause defective soldering due excessive flow of adhesive on to the land or solder pad.

[Recommended conditions]

Figure	0805 case sizes as examples
a	0.3mm min
b	100~120 μm
c	Area with no adhesive



### 4. Soldering

#### Precautions

- ◆ Selection of Flux
  1. Since flux may have a significant effect on the performance of inductors, it is necessary to verify the following conditions prior to use;
    - (1) Flux used should be with less than or equal to 0.1 wt% (Chlorine conversion method) of halogenated content. Flux having a strong acidity content should not be applied.
    - (2) When soldering inductors on the board, the amount of flux applied should be controlled at the optimum level.
    - (3) When using water-soluble flux, special care should be taken to properly clean the boards.
- ◆ Soldering
  1. Temperature, time, amount of solder, etc. are specified in accordance with the following recommended conditions, and please contact us about peak temperature when you use lead-free paste.

◆ Selection of Flux

- 1-1. When too much halogenated substance (Chlorine, etc.) content is used to activate the flux, or highly acidic flux is used, an excessive amount of residue after soldering may lead to corrosion of the terminal electrodes or degradation of insulation resistance on the surface of the Inductor.
- 1-2. Flux is used to increase solderability in flow soldering, but if too much is applied, a large amount of flux gas may be emitted and may detrimentally affect solderability. To minimize the amount of flux applied, it is recommended to use a flux-bubbling system.
- 1-3. Since the residue of water-soluble flux is easily dissolved by water content in the air, the residue on the surface of Inductor in high humidity conditions may cause a degradation of insulation resistance and therefore affect the reliability of the components. The cleaning methods and the capability of the machines used should also be considered carefully when selecting water-soluble flux.

◆ Soldering

1-1. Preheating when soldering

Heating: Chip inductor components should be preheated to within 100 to 130°C of the soldering. Cooling: The temperature difference between the components and cleaning process should not be greater than 100°C.

Chip inductors are susceptible to thermal shock when exposed to rapid or concentrated heating or rapid cooling. Therefore, the soldering process must be conducted with a great care so as to prevent malfunction of the components due to excessive thermal shock.

[Reflow soldering]

【Recommended conditions for eutectic soldering】

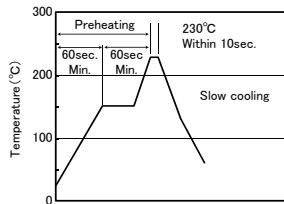

【Recommended condition for Pb-free soldering】

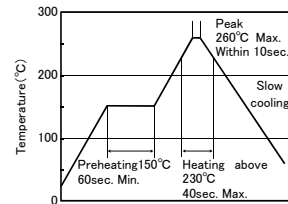

- ※Ceramic chip components should be preheated to within 100 to 130°C of the soldering.
- ※Assured to be reflow soldering for 2 times.
- ※MC series; Peak 230°C (eutectic soldering), 260°C (Pb-free soldering) max within 5sec.

Caution

1. The ideal condition is to have solder mass (fillet) controlled to 1/2 to 1/3 of the thickness of the inductor, as shown below:

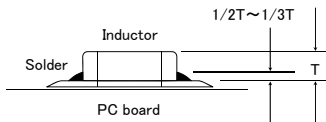

2. Because excessive dwell times can detrimentally affect solderability, soldering duration should be kept as close to recommended times as possible.

[Wave soldering]

【Recommended conditions for eutectic soldering】

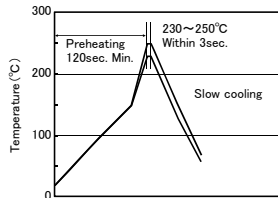

【Recommended condition for Pb-free soldering】

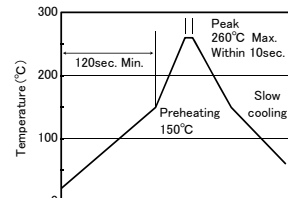

- ※Ceramic chip components should be preheated to within 100 to 130°C of the soldering.
- ※Assured to be wave soldering for 1 time.
- ※Except for reflow soldering type.

Caution

1. Make sure the inductors are preheated sufficiently.
2. The temperature difference between the inductor and melted solder should not be greater than 100 to 130°C.
3. Cooling after soldering should be as gradual as possible.
4. Wave soldering must not be applied to the inductors designated as for reflow soldering only.

[Hand soldering]

【Recommended conditions for eutectic soldering】

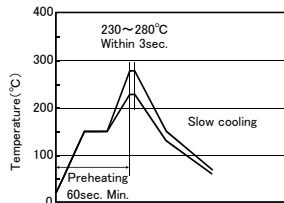

【Recommended condition for Pb-free soldering】

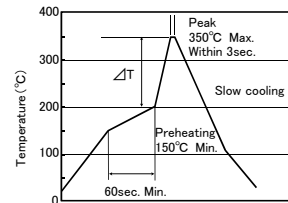

- ※ $\Delta T \leq 190^\circ\text{C}$  (3216 Type max),  $\Delta T \leq 130^\circ\text{C}$  (3225 Type min)
- ※It is recommended to use 20W soldering iron and the tip is 1φ or less.
- ※The soldering iron should not directly touch the components.
- ※Assured to be soldering iron for 1 time.
- Note: The above profiles are the maximum allowable soldering condition, therefore these profiles are not always recommended.

Technical considerations

	<p>Caution</p> <ol style="list-style-type: none"> <li>1. Use a 20W soldering iron with a maximum tip diameter of 1.0 mm.</li> <li>2. The soldering iron should not directly touch the inductor.</li> </ol>						
<b>5. Cleaning</b>							
Precautions	<p>◆Cleaning conditions</p> <ol style="list-style-type: none"> <li>1. When cleaning the PC board after the Inductors are all mounted, select the appropriate cleaning solution according to the type of flux used and purpose of the cleaning (e.g. to remove soldering flux or other materials from the production process.)</li> <li>2. Cleaning conditions should be determined after verifying, through a test run, that the cleaning process does not affect the inductor's characteristics.</li> </ol>						
Technical considerations	<p>◆Cleaning conditions</p> <ol style="list-style-type: none"> <li>1. The use of inappropriate solutions can cause foreign substances such as flux residue to adhere to the inductor, resulting in a degradation of the inductor's electrical properties (especially insulation resistance).</li> <li>2. Inappropriate cleaning conditions (insufficient or excessive cleaning) may detrimentally affect the performance of the inductors. <ol style="list-style-type: none"> <li>(1) Excessive cleaning <ol style="list-style-type: none"> <li>a. In the case of ultrasonic cleaning, too much power output can cause excessive vibration of the PC board which may lead to the cracking of the inductor or the soldered portion, or decrease the terminal electrodes' strength. Thus the following conditions should be carefully checked; <table border="0" style="margin-left: 40px;"> <tr> <td>Ultrasonic output</td> <td>Below 20W/l</td> </tr> <tr> <td>Ultrasonic frequency</td> <td>Below 40kHz</td> </tr> <tr> <td>Ultrasonic washing period</td> <td>5 min. or less</td> </tr> </table> </li> </ol> </li> </ol> </li> </ol>	Ultrasonic output	Below 20W/l	Ultrasonic frequency	Below 40kHz	Ultrasonic washing period	5 min. or less
Ultrasonic output	Below 20W/l						
Ultrasonic frequency	Below 40kHz						
Ultrasonic washing period	5 min. or less						
<b>6. Post cleaning processes</b>							
Precautions	<p>◆Application of resin coatings, moldings, etc. to the PCB and components.</p> <ol style="list-style-type: none"> <li>1. With some type of resins a decomposition gas or chemical reaction vapor may remain inside the resin during the hardening period or while left under normal storage conditions resulting in the deterioration of the inductor's performance.</li> <li>2. When a resin's hardening temperature is higher than the inductor's operating temperature, the stresses generated by the excess heat may lead to inductor damage or destruction.</li> <li>3. Stress caused by a resin's temperature generated expansion and contraction may damage inductors.</li> </ol> <p>The use of such resins, molding materials etc. is not recommended.</p>						
<b>7. Handling</b>							
Precautions	<p>◆Breakaway PC boards (splitting along perforations)</p> <ol style="list-style-type: none"> <li>1. When splitting the PC board after mounting inductors and other components, care is required so as not to give any stresses of deflection or twisting to the board.</li> <li>2. Board separation should not be done manually, but by using the appropriate devices.</li> </ol> <p>◆General handling precautions</p> <ol style="list-style-type: none"> <li>1. Always wear static control bands to protect against ESD.</li> <li>2. Keep the inductors away from all magnets and magnetic objects.</li> <li>3. Use non-magnetic tweezers when handling inductors.</li> <li>4. Any devices used with the inductors ( soldering irons, measuring instruments) should be properly grounded.</li> <li>5. Keep bare hands and metal products (i.e., metal desk) away from chip electrodes or conductive areas that lead to chip electrodes.</li> <li>6. Keep inductors away from items that generate magnetic fields such as speakers or coils.</li> </ol> <p>◆Mechanical considerations</p> <ol style="list-style-type: none"> <li>1. Be careful not to subject the inductors to excessive mechanical shocks. <ol style="list-style-type: none"> <li>(1) If inductors are dropped on the floor or a hard surface they should not be used.</li> <li>(2) When handling the mounted boards, be careful that the mounted components do not come in contact with or bump against other boards or components.</li> </ol> </li> </ol>						
<b>8. Storage conditions</b>							
Precautions	<p>◆Storage</p> <ol style="list-style-type: none"> <li>1. To maintain the solderability of terminal electrodes and to keep the packaging material in good condition, care must be taken to control temperature and humidity in the storage area. Humidity should especially be kept as low as possible. <ul style="list-style-type: none"> <li>•Recommended conditions <p style="margin-left: 20px;">Ambient temperature: Below 30°C    Humidity: Below 70% RH</p> <p style="margin-left: 20px;">The ambient temperature must be kept below 40°C. Even under ideal storage conditions, solderability of inductor is deteriorated as time passes, so inductors should be used within 6 months from the time of delivery.</p> </li> <li>•Inductor should be kept where no chlorine or sulfur exists in the air.</li> </ul> </li> </ol>						
Technical considerations	<p>◆Storage</p> <ol style="list-style-type: none"> <li>1. If the parts are stocked in a high temperature and humidity environment, problems such as reduced solderability caused by oxidation of terminal electrodes and deterioration of taping/packaging materials may take place. For this reason, components should be used within 6 months from the time of delivery. If exceeding the above period, please check solderability before using the inductors.</li> </ol>						

▶ This catalog contains the typical specification only due to the limitation of space. When you consider the purchase of our products, please check our specification. For details of each product (characteristics graph, reliability information, precautions for use, and so on), see our Web site (<http://www.ty-top.com/>).

# SMD COMMON MODE CHOKE COILS FOR DC AND SIGNAL LINES



REFLOW

■ PARTS NUMBER

\*Operating Temp. : -25~+105°C (Including self-generated heat)

B	U	0	5	M	C	△	0	1	△	T	△
①	②	③	④	⑤	⑥						

△=Blank space

① Series name

Code	Series name
BU	Common mode choke coil

④ Product classification code

Code	Product classification code
△01~△10	Product classification code

② Dimensions of core

Code	Dimensions of core [mm]
05	5.0

⑤ Packaging

Code	Packaging
△T	Taping

③ Shape

Code	Shape
MC	Surface mount type

⑥ Internal code

Code	Internal code
△	Standard

■ STANDARD EXTERNAL DIMENSIONS / MINIMUM QUANTITY

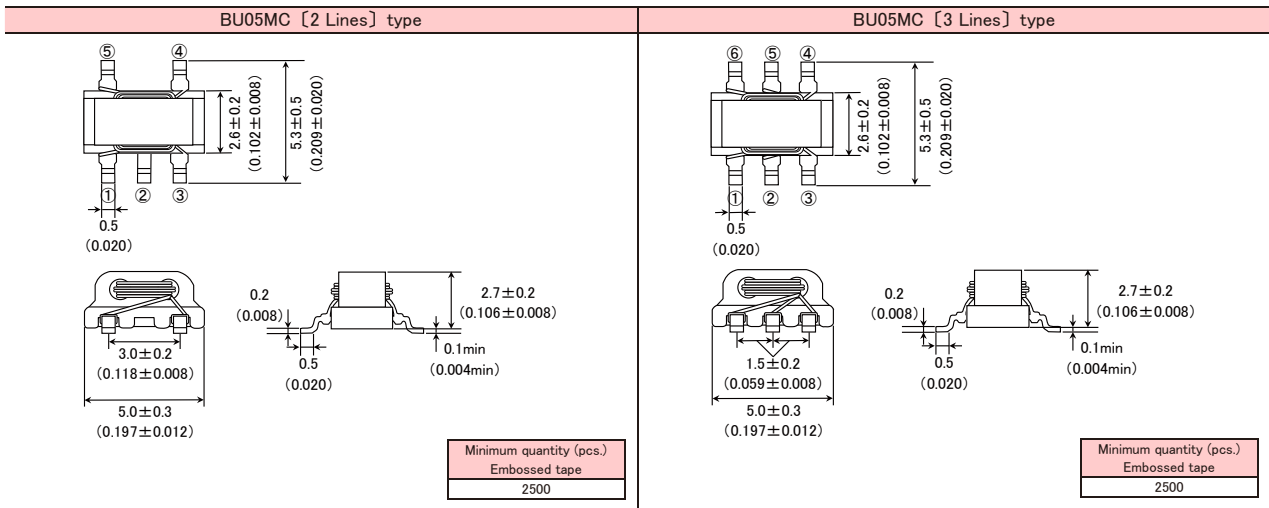

Unit : mm (inch)

The values without tolerance are for reference only.

■ PARTS NUMBER

Parts number	EHS	Number of lines	Impedance [Ω] (typ.)	Measuring frequency [MHz]	DC Resistance [Ω] (max.)	Rated current [A] (max.)	Rated voltage [V] (D.C.)	Insulation resistance [MΩ] (min.)
BU05MC 01 T	RoHS	2	1000	60	0.12	1.0	50	100
BU05MC 08 T	RoHS	3	700	60	0.11	0.5	50	100

► This catalog contains the typical specification only due to the limitation of space. When you consider the purchase of our products, please check our product specification sheets. For details of each product (characteristics graph, reliability information, precautions for use, and so on), see our website (<http://www.ty-top.com/>).

# SMD COMMON MODE CHOKE COILS FOR DC AND SIGNAL LINES, BALUN TRANSFORMERS

## PACKAGING

### ① Minimum Quantity

Type	Minimum Quantity [pcs]	
	Box	Taping
BU05MC	—	2500
BU06MB	150	—

### ② Tape material

#### ● Embossed Tape

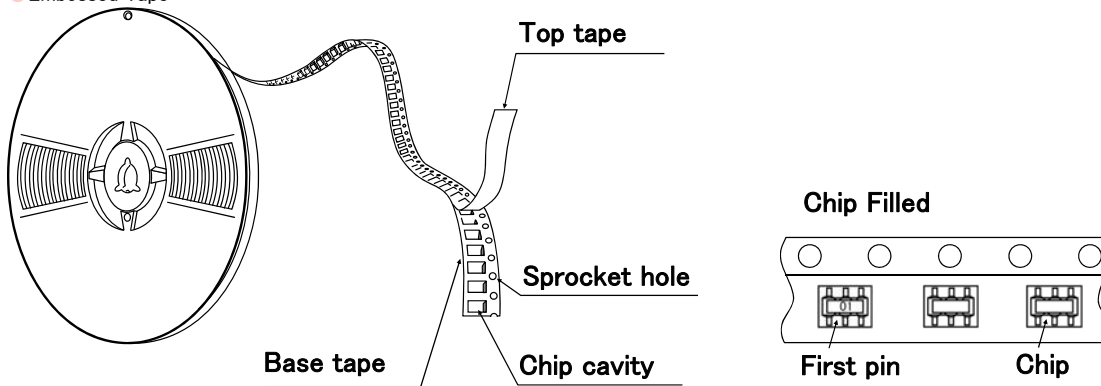

### ③ Taping dimensions

#### ● Embossed tape 12mm wide (0.472 inches wide)

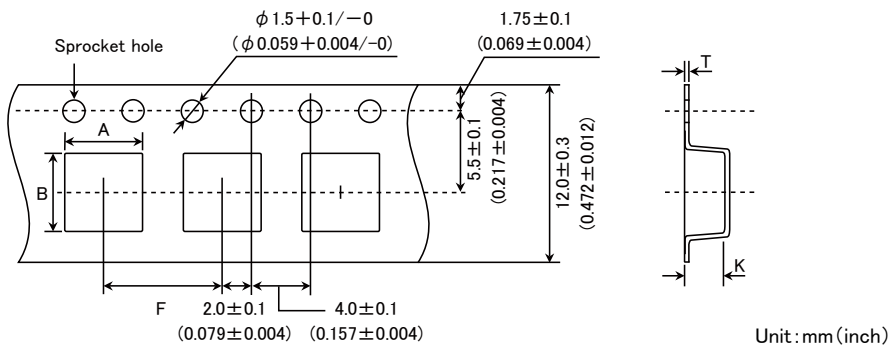

Type	Insertion pitch	Chip cavity		Tape thickness	
		A	B	K	T
BU05MC	$8.0 \pm 0.1$ ( $0.315 \pm 0.004$ )	$5.2 \pm 0.1$ ( $0.205 \pm 0.004$ )	$5.6 \pm 0.1$ ( $0.220 \pm 0.004$ )	$3.2 \pm 0.1$ ( $0.126 \pm 0.004$ )	$0.4 \pm 0.05$ ( $0.016 \pm 0.002$ )

Unit: mm (inch)

### ④ Leader and Blank portion

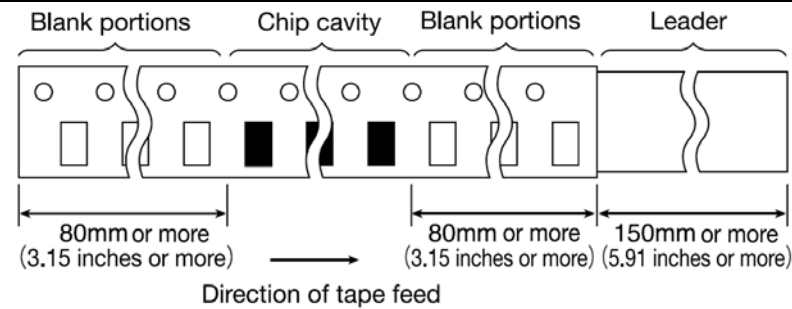

▶ This catalog contains the typical specification only due to the limitation of space. When you consider the purchase of our products, please check our specification. For details of each product (characteristics graph, reliability information, precautions for use, and so on), see our Web site (<http://www.ty-top.com/>).

⑤ Reel size

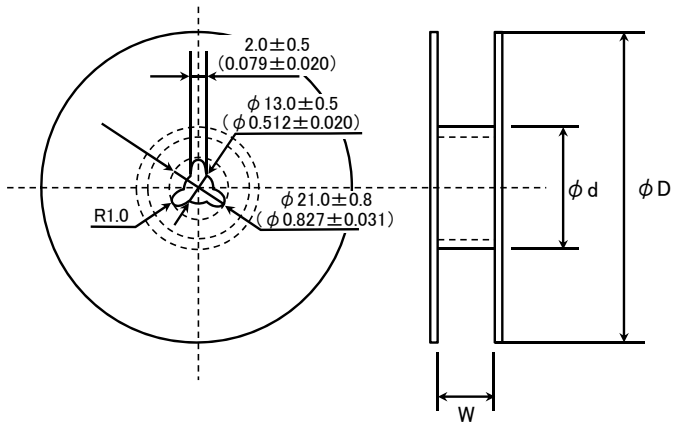

Type	$\phi D$	$\phi d$	W
BU05MC	$330 \pm 2.0$ ( $12.99 \pm 0.079$ )	$80 \pm 1.0$ ( $3.15 \pm 0.039$ )	$13.5 \pm 1.0$ ( $0.53 \pm 0.039$ )

Unit : mm (inch)



# SMD COMMON MODE CHOKE COILS FOR DC AND SIGNAL LINES, BALUN TRANSFORMERS

## PRECAUTIONS

### 1. Circuit Design

Precautions	<ul style="list-style-type: none"> <li>◆Operating environment               <ol style="list-style-type: none"> <li>1. The products described in this specification are intended for use in general electronic equipment, (office supply equipment, telecommunications systems, measuring equipment, and household equipment). They are not intended for use in mission-critical equipment or systems requiring special quality and high reliability (traffic systems, safety equipment, aerospace systems, nuclear control systems and medical equipment including life-support systems,) where product failure might result in loss of life, injury or damage. For such uses, contact TAIYO YUDEN Sales Department in advance.</li> </ol> </li> </ul>
-------------	--

### 2. PCB Design

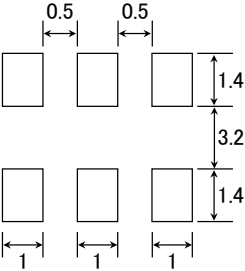
Precautions	<ul style="list-style-type: none"> <li>◆Land pattern design               <ol style="list-style-type: none"> <li>1. Please contact any of our offices for a land pattern, and refer to a recommended land pattern of specifications.</li> </ol> </li> </ul>
Technical considerations	<ul style="list-style-type: none"> <li>◆Land pattern design               <p>Surface Mounting</p> <ul style="list-style-type: none"> <li>• Mounting and soldering conditions should be checked beforehand.</li> <li>• Applicable soldering process to these products is reflow soldering only.</li> <li>• Recommended Land Patterns</li> </ul> <p>【BU05MC】</p>  <p style="text-align: right;">Unit: mm</p> </li> </ul>

### 3. Considerations for automatic placement

Precautions	<ul style="list-style-type: none"> <li>◆Adjustment of mounting machine               <ol style="list-style-type: none"> <li>1. Excessive impact load should not be imposed on the products when mounting onto the PC boards.</li> <li>2. Mounting and soldering conditions should be checked beforehand.</li> </ol> </li> </ul>
Technical considerations	<ul style="list-style-type: none"> <li>◆Adjustment of mounting machine               <ol style="list-style-type: none"> <li>1. When installing products, care should be taken not to apply distortion stress as it may deform the products.</li> </ol> </li> </ul>

### 4. Soldering

Precautions	<ul style="list-style-type: none"> <li>◆Reflow soldering               <ol style="list-style-type: none"> <li>1. Please contact any of our offices for a reflow soldering, and refer to the recommended condition specified.</li> <li>2. This product can be used reflow soldering only.</li> <li>3. Please do not add any stress to a product until it returns in normal temperature after reflow soldering.</li> </ol> </li> <li>◆Lead free soldering               <ol style="list-style-type: none"> <li>1. When using products with lead free soldering, we request to use them after confirming adhesion, temperature of resistance to soldering heat, soldering etc sufficiently.</li> </ol> </li> <li>◆Recommended conditions for using a soldering iron               <p>【BU05MC】</p> <ul style="list-style-type: none"> <li>• Put the soldering iron on the land-pattern.</li> <li>• Soldering iron's temperature – Below 350°C</li> <li>• Duration – 3 seconds or less</li> <li>• The soldering iron should not directly touch the inductor.</li> </ul> </li> </ul>
Technical considerations	<ul style="list-style-type: none"> <li>◆Reflow soldering               <ol style="list-style-type: none"> <li>1. If products are used beyond the range of the recommended conditions, heat stresses may deform the products, and consequently degrade the reliability of the products.</li> </ol> </li> <li>◆Recommended conditions for using a soldering iron               <p>If products are used beyond the range of the recommended conditions, heat stresses may deform the products, and consequently degrade the reliability of the products.</p> </li> </ul>

### 5. Cleaning

Precautions	<ul style="list-style-type: none"> <li>◆Cleaning conditions               <ol style="list-style-type: none"> <li>1. Please contact any of our offices for a cleaning.</li> </ol> </li> </ul>
-------------	--

▶ This catalog contains the typical specification only due to the limitation of space. When you consider the purchase of our products, please check our specification. For details of each product (characteristics graph, reliability information, precautions for use, and so on), see our Web site (<http://www.ty-top.com/>).

6. Handling	
Precautions	<ul style="list-style-type: none"> <li>◆ Handling               <ol style="list-style-type: none"> <li>1. Keep the product away from all magnets and magnetic objects.</li> </ol> </li> <li>◆ Breakaway PC boards (splitting along perforations)               <ol style="list-style-type: none"> <li>1. When splitting the PC board after mounting product, care should be taken not to give any stresses of deflection or twisting to the board.</li> <li>2. Board separation should not be done manually, but by using the appropriate devices.</li> </ol> </li> <li>◆ Mechanical considerations               <ol style="list-style-type: none"> <li>1. Please do not give the product any excessive mechanical shocks.</li> <li>2. Please do not add any shock and power to a product in transportation.</li> </ol> </li> <li>◆ Pick-up pressure               <ol style="list-style-type: none"> <li>1. Please do not push to add any pressure to a winding part. Please do not give any shock and push onto an exposed part of ferrite cores.</li> </ol> </li> <li>◆ Packing               <ol style="list-style-type: none"> <li>1. Please avoid accumulation of a packing box as much as possible.</li> </ol> </li> </ul>
Technical considerations	<ul style="list-style-type: none"> <li>◆ Handling               <ol style="list-style-type: none"> <li>1. There is a case that a characteristic varies with magnetic influence.</li> </ol> </li> <li>◆ Breakaway PC boards (splitting along perforations)               <ol style="list-style-type: none"> <li>1. The position of the product on PCBs shall be carefully considered to minimize the stress caused from splitting of the PCBs.</li> </ol> </li> <li>◆ Mechanical considerations               <ol style="list-style-type: none"> <li>1. There is a case to be damaged by a mechanical shock.</li> <li>2. There is a case to be broken by the handling in transportation.</li> </ol> </li> <li>◆ Pick-up pressure               <ol style="list-style-type: none"> <li>1. An excessive shock or stress may cause a damage to the product or a deterioration of a characteristic.</li> </ol> </li> <li>◆ Packing               <ol style="list-style-type: none"> <li>1. If packing boxes are accumulated, that could cause a deformation on packing tapes or a damage on the products.</li> </ol> </li> </ul>
7. Storage conditions	
Precautions	<ul style="list-style-type: none"> <li>◆ Storage               <ol style="list-style-type: none"> <li>1. To maintain the solderability of terminal electrodes and to keep the packing material in good condition, temperature and humidity in the storage area should be controlled.                   <ul style="list-style-type: none"> <li>• Recommended conditions                       <ul style="list-style-type: none"> <li>Ambient temperature : 0~40°C, Humidity : Below 70% RH</li> </ul> </li> </ul> </li> </ol> <p>The ambient temperature must be kept below 30°C. Even under ideal storage conditions, the solderability of electrodes may decrease gradually. For this reason, the products should be used within one year from the time of delivery. In case of storage over 6 months, solderability shall be checked before actual usage.</p> </li> </ul>
Technical considerations	<ul style="list-style-type: none"> <li>◆ Storage               <ol style="list-style-type: none"> <li>1. Under a high temperature and humidity environment, problems such as reduced solderability caused by oxidation of terminal electrodes and deterioration of taping/packaging materials may take place.</li> </ol> </li> </ul>

# LEADED COMMON MODE CHOKE COILS FOR DC AND SIGNAL LINES

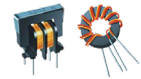

WAVE

## PARTS NUMBER

\* Operating Temp.: -25~+105°C (Including self-generated heat)

T	L	F	△	9	U	B	H	3	0	2	W	K	1
①	②	③	④	⑤	⑥								

△=Blank space

### ①Series name

Code	Series name
TLF	Common mode choke coil

### ②Dimensions of core

Code	Dimensions of core [mm]
△9	9

### ③Shape

Code	Shape
UB△	U core, vertically split wound
UBH	U core, horizontally split wound

### ④Nominal inductance

Code (example)	Nominal inductance [μH]
302	3000
203	20000

### ⑤Inductance tolerance

Code	Inductance tolerance
W	+100/-10%

### ⑥Internal code

Code	Internal code
K1	Adhesive fixation

## STANDARD EXTERNAL DIMENSIONS / MINIMUM QUANTITY

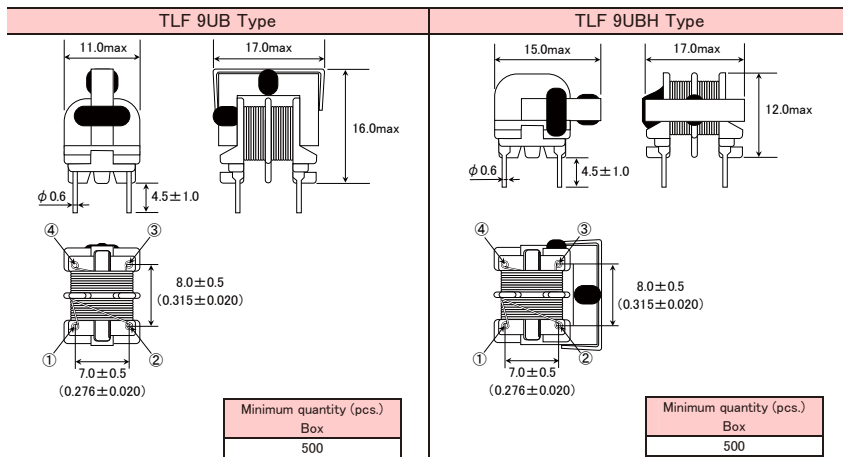

Unit: mm (inch)

## PARTS NUMBER

Parts number	EHS	Number of lines	Nominal inductance [mH]	Inductance tolerance	DC Resistance [Ω] (max.)	Rated current [A] (max.)	Rated voltage [V] (D.C.)	Insulation resistance [MΩ] (min.)
TLF 9UBH302W K1	RoHS	2	3.0	+100/-10%	1.5	0.40	50	100
TLF 9UB 302W K1	RoHS	2	3.0	+100/-10%	1.5	0.40	50	100
TLF 9UBH802W K1	RoHS	2	8.0	+100/-10%	3.0	0.30	50	100
TLF 9UB 802W K1	RoHS	2	8.0	+100/-10%	3.0	0.30	50	100
TLF 9UBH203W K1	RoHS	2	20.0	+100/-10%	6.5	0.18	50	100
TLF 9UB 203W K1	RoHS	2	20.0	+100/-10%	6.5	0.18	50	100

▶ This catalog contains the typical specification only due to the limitation of space. When you consider the purchase of our products, please check our product specification sheets. For details of each product (characteristics graph, reliability information, precautions for use, and so on), see our website (<http://www.ty-top.com/>).

# LEADED COMMON MODE CHOKE COILS FOR AC LINES



WAVE

## PARTS NUMBER

\*Operating Temp. : -25~+105°C (Including self-generated heat)

T	L	F	△	9	U	A	△	1	0	2	△	0	R	8	K	1
①	②	③	④	⑤	⑥	⑦										

△=Blank space

### ① Series name

Code	Series name
TLF	Common mode choke
TLH	Hybrid choke

### ② Dimensions of core

Code	Dimensions of core [mm]
△9	9
10	10

### ③ Shape

Code	Shape
UA△	U core, vertical type
UAH	U core, horizontal type
UB△	U core, vertically split wound
CB△	Square type core vertically split wound
CBH	Square type core horizontally split wound
HB△	Double-square type core vertically split wound
HBH	Double-square type core horizontally split wound

### ④ Nominal Inductance

Code (example)	Nominal Inductance [μH]
102	1000
103	10000

### ⑤ Inductance tolerance

Code	Inductance tolerance
△	Nominal Values or higher
W	+100/-10%

### ⑥ Rated current

Code	Rated current [A]
R54	0.54
0R8	0.8

※R=Decimal point

### ⑦ Internal code

Code	Internal code
K1	Adhesive fixation

## STANDARD EXTERNAL DIMENSIONS / MINIMUM QUANTITY

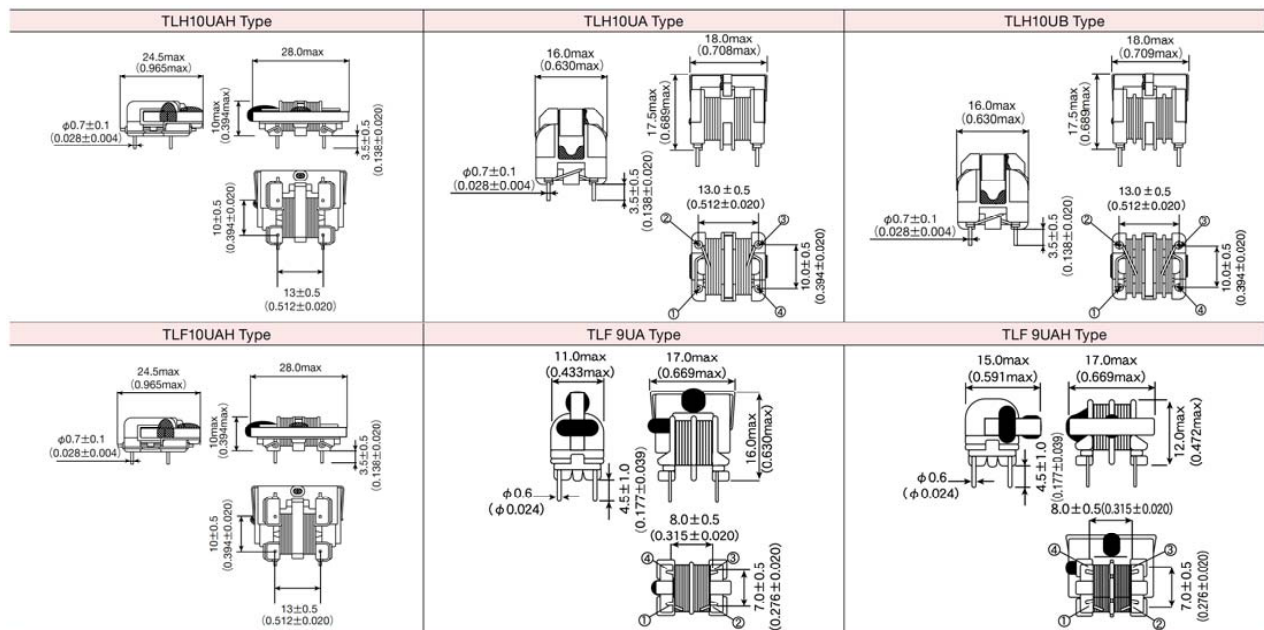

Type	Minimum quantity (pcs.) Box
TLH type	500
TLF type	

▶ This catalog contains the typical specification only due to the limitation of space. When you consider the purchase of our products, please check our product specification sheets. For details of each product (characteristics graph, reliability information, precautions for use, and so on), see our website (<http://www.ty-top.com/>).

PARTS NUMBER

TLH10UAH type (Hybrid choke)

Parts number	EHS	Common mode inductance [mH]	Inductance tolerance	Normal mode inductance [mH] (typ.)	DC Resistance [ $\Omega$ ] (max.)	Rated current [A] (max.)	Rated voltage AC [V] (max.)
TLH10UAH872 0R7	RoHS	8.7	min.	0.70	1.00	0.7	250
TLH10UAH992 0R6	RoHS	9.9	min.	0.85	1.35	0.6	250
TLH10UAH123 0R5	RoHS	12	min.	1.06	1.60	0.5	250

TLH10UA type (Hybrid choke)

Parts number	EHS	Common mode inductance [mH]	Inductance tolerance	Normal mode inductance [mH] (typ.)	DC Resistance [ $\Omega$ ] (max.)	Rated current [A] (max.)	Rated voltage AC [V] (max.)
TLH10UA 901 2R0	RoHS	0.9	min.	0.067	0.089	2.0	250
TLH10UA 112 1R8	RoHS	1.1	min.	0.087	0.126	1.8	250
TLH10UA 152 1R6	RoHS	1.5	min.	0.126	0.171	1.6	250
TLH10UA 212 1R4	RoHS	2.1	min.	0.160	0.222	1.4	250
TLH10UA 282 1R2	RoHS	2.8	min.	0.215	0.272	1.2	250
TLH10UA 432 1R0	RoHS	4.3	min.	0.330	0.398	1.0	250
TLH10UA 622 0R8	RoHS	6.2	min.	0.430	0.578	0.8	250
TLH10UA 872 0R7	RoHS	8.7	min.	0.644	0.878	0.7	250
TLH10UA 992 0R6	RoHS	9.9	min.	0.836	1.138	0.6	250
TLH10UA 143 0R5	RoHS	14	min.	1.256	1.567	0.5	250

TLH10UB type (Hybrid choke)

Parts number	EHS	Common mode inductance [mH]	Inductance tolerance	Normal mode inductance [mH] (typ.)	DC Resistance [ $\Omega$ ] (max.)	Rated current [A] (max.)	Rated voltage AC [V] (max.)
TLH10UB 701 2R0	RoHS	0.7	min.	0.056	0.097	2.0	250
TLH10UB 112 1R7	RoHS	1.1	min.	0.068	0.133	1.7	250
TLH10UB 142 1R4	RoHS	1.4	min.	0.113	0.214	1.4	250
TLH10UB 232 1R2	RoHS	2.3	min.	0.150	0.274	1.2	250
TLH10UB 352 1R0	RoHS	3.5	min.	0.232	0.422	1.0	250
TLH10UB 442 0R8	RoHS	4.4	min.	0.328	0.624	0.8	250
TLH10UB 872 0R7	RoHS	8.7	min.	0.580	0.982	0.7	250
TLH10UB 972 0R6	RoHS	9.7	min.	0.735	1.314	0.6	250
TLH10UB 113 0R5	RoHS	11	min.	0.877	1.577	0.5	250

TLF10UAH type

Parts number	EHS	Common mode inductance [mH]	Inductance tolerance	DC Resistance [ $\Omega$ ] (max.)	Rated current [A] (max.)	Rated voltage AC [V] (max.)
TLF10UAH872 0R7	RoHS	8.7	min.	1.00	0.7	250
TLF10UAH992 0R6	RoHS	9.9	min.	1.35	0.6	250
TLF10UAH123 0R5	RoHS	12	min.	1.60	0.5	250

TLF 9UA type

Parts number	EHS	Common mode inductance [mH]	Inductance tolerance	DC Resistance [ $\Omega$ ] (max.)	Rated current [A] (max.)	Rated voltage AC [V] (max.)
TLF 9UA 102W0R8K1	RoHS	1.0	+100/-10%	0.5	0.80	250
TLF 9UA 202WR54K1	RoHS	2.0	+100/-10%	1.0	0.54	250
TLF 9UA 302WR42K1	RoHS	3.0	+100/-10%	1.5	0.42	250
TLF 9UA 502WR32K1	RoHS	5.0	+100/-10%	2.5	0.32	250
TLF 9UA 802WR25K1	RoHS	8.0	+100/-10%	4.0	0.25	250
TLF 9UA 103WR23K1	RoHS	10	+100/-10%	4.5	0.23	250

TLF 9UAH type

Parts number	EHS	Common mode inductance [mH]	Inductance tolerance	DC Resistance [ $\Omega$ ] (max.)	Rated current [A] (max.)	Rated voltage AC [V] (max.)
TLF 9UAH102W0R8K1	RoHS	1.0	+100/-10%	0.5	0.80	250
TLF 9UAH202WR54K1	RoHS	2.0	+100/-10%	1.0	0.54	250
TLF 9UAH302WR42K1	RoHS	3.0	+100/-10%	1.5	0.42	250
TLF 9UAH502WR32K1	RoHS	5.0	+100/-10%	2.5	0.32	250
TLF 9UAH802WR25K1	RoHS	8.0	+100/-10%	4.0	0.25	250
TLF 9UAH103WR23K1	RoHS	10	+100/-10%	4.5	0.23	250

▶ This catalog contains the typical specification only due to the limitation of space. When you consider the purchase of our products, please check our product specification sheets. For details of each product (characteristics graph, reliability information, precautions for use, and so on), see our website (<http://www.ty-top.com/>).

# LEADED COMMON MODE CHOKE COILS FOR DC AND SIGNAL LINES

## LEADED COMMON MODE CHOKE COILS FOR AC LINES

---

### ■ PACKAGING

---

#### ① Minimum Quantity

---

##### ● TLH/TLF Type

Type	Minimum Quantity [pcs]
	Box
TLH10UA□	1000
TLH10UB	
TLF10UAH	
TLF9UA□	500
TLF9UB□	

---

# LEADED COMMON MODE CHOKE COILS FOR DC AND SIGNAL LINES, LEADED COMMON MODE CHOKE COILS FOR AC LINES

## RELIABILITY DATA

1. Operating Temperature Range										
Specified Value	TLH, TLF Type	-25 ~ + 105°C								
Test Method and Remarks	Including temperature rise due to self-generated heat.									
2. Storage temperature range										
Specified Value	TLH, TLF Type	-40 ~ + 85°C								
3. Rated current										
Specified Value	TLH, TLF Type	Within the specified range								
Test Method and Remarks	TLH10U, TLF10UA : The maximum value of AC current within the temperature rise of 60°C TLF9UA, : The maximum value of AC current within the temperature rise of 45°C TLF9UB : The maximum value of DC current within the temperature rise of 45°C									
4. Inductance										
Specified Value	TLH, TLF Type	Within the specified tolerance								
Test Method and Remarks	TLF9U : Measuring equipment : LCR meter 4284A or its equivalent Measuring frequency : 1kHz Measuring voltage : 1Vrms TLH, TLF (except TLF9U) : Measuring equipment : LCR meter 4284A or its equivalent Measuring frequency : 1kHz Measuring voltage : 0.1Vrms									
5. DC resistance										
Specified Value	TLH, TLF Type	Within the specified tolerance								
Test Method and Remarks	Measuring equipment : DC ohmmeter									
6. Terminal strength tensile force										
Specified Value	TLH, TLF Type	No abnormality								
Test Method and Remarks	TLH10UA, TLH10UB, TLF9U : Apply the stated tensile force gradually in the direction to draw terminal. <table border="1"> <thead> <tr> <th>force [N]</th> <th>duration [s]</th> </tr> </thead> <tbody> <tr> <td>5</td> <td>30±5</td> </tr> </tbody> </table> TLH10UAH, TLF (except TLF9U): Apply the stated tensile force gradually in the direction to draw terminal. <table border="1"> <thead> <tr> <th>force [N]</th> <th>duration [s]</th> </tr> </thead> <tbody> <tr> <td>10</td> <td>30±5</td> </tr> </tbody> </table>		force [N]	duration [s]	5	30±5	force [N]	duration [s]	10	30±5
force [N]	duration [s]									
5	30±5									
force [N]	duration [s]									
10	30±5									
7. Insulation resistance between wires										
Specified Value	TLH, TLF Type	100M Ω min.								
Test Method and Remarks	Applied voltage : 500VDC (TLH, TLF (except TLF9UB)) : 250VDC (TLF9UB) Duration : 60sec.									

▶ This catalog contains the typical specification only due to the limitation of space. When you consider the purchase of our products, please check our specification. For details of each product (characteristics graph, reliability information, precautions for use, and so on), see our Web site (<http://www.ty-top.com/>).

8. Insulation resistance between wire and core		
Specified Value	TLH, TLF Type	100M $\Omega$ min. (except TLH, TLF10UAH Type)
Test Method and Remarks	TLF : Applied voltage : 500VDC (TLF (except TLF9UB)) : 250VDC (TLF9UB) Duration : 60 sec.	
9. Withstanding : between wires		
Specified Value	TLH, TLF Type	No abnormality
Test Method and Remarks	Applied voltage : 2000VAC (TLH, TLF (except TLF9UB)) : 500VDC (TLF9UB) Duration : 60sec	
10. Withstanding : between wires and core		
Specified Value	TLH, TLF Type	No abnormality (except TLH, TLF10UAH Type)
Test Method and Remarks	TLF : Applied voltage : 2000VAC (TLF (except TLF9UB)) : 500VDC (TLF9UB) Duration : 60sec.	
11. Rated voltage		
Specified Value	TLH, TLF Type	Within the specified range
Test Method and Remarks	TLH, TLF (except TLF9UB) : 250VAC TLF9UB : 50VDC	
12. Resistance to vibration		
Specified Value	TLH, TLF Type	TLF9U : Inductance change : Within $\pm 5\%$ TLH, TLF (except TLF9U) : Appearance is no abnormality and within the specified range
Test Method and Remarks	TLH, TLF : According to JIS C60068-2-6. Direction : 2hrs each in X, Y and Z direction Total : 6hrs Frequency range : 10 to 55 to 10Hz (1 min.) Amplitude : 1.5mm (shall not exceed acceleration 196m/s <sup>2</sup> ) Mounting method : soldering onto PC board Recovery : At least 1hr of recovery under the standard condition after the removal from test chamber, followed by the measurement within 2hrs.	
13. Solderability		
Specified Value	TLH, TLF Type	At least 90% of terminal electrode is covered by new solder.
Test Method and Remarks	TLH, TLF : Solder temperature : 235 $\pm$ 0.5 $^{\circ}$ C Duration : 2 $\pm$ 0.5sec. Immersion depth : Up to 1.5 to 2.0mm from PBC mounted level.  TLH, TLF : Solder temperature : 245 $\pm$ 5 $^{\circ}$ C Duration : 4 $\pm$ 1sec. Immersion depth : Up to 1.0 to 1.5mm from PBC mounted level.	

▶ This catalog contains the typical specification only due to the limitation of space. When you consider the purchase of our products, please check our specification. For details of each product (characteristics graph, reliability information, precautions for use, and so on), see our Web site (<http://www.ty-top.com/>).



14. Resistance to soldering heat		
Specified Value	TLH, TLF Type	TLF9UA : Inductance change : Within $\pm 5\%$
Test Method and Remarks	TLH, TLF : Solder temperature : $260 \pm 5^\circ\text{C}$ Duration : $5 \pm 0.5\text{sec.}$ Immersion depth : Up to 1.5 to 2.0mm from PBC mounted level. Recovery : At least 1hr of recovery under the standard condition after the removal from test chamber, followed by the measurement within 2hrs.  TLH, TLF : Solder temperature : $260 \pm 5^\circ\text{C}$ Duration : $10 \pm 1\text{sec.}$ Immersion depth : Up to 1.0 to 1.5mm from PBC mounted level. Recovery : At least 1hr of recovery under the standard condition after the removal from test chamber, followed by the measurement within 2hrs.	

15. Thermal shock		
Specified Value	TLH, TLF Type	TLF9UA : Inductance change : Within $\pm 15\%$ TLH, TLF (except TLF9UA) : Withstanding voltage : No abnormality Insulation resistance : No abnormality
Test Method and Remarks	TLH, TLF : According to JIS C60068-2-14. Conditions for 1 cycle $-25^\circ\text{C} \sim +85^\circ\text{C}$ , keep each 30min  Number of cycles : 10 Recovery : At least 1hr of recovery under the standard condition after the removal from test chamber, followed by the measurement within 2 hrs.	

16. Damp heat		
Specified Value	TLH, TLF Type	TLF9UA : Inductance change : Within $\pm 15\%$ TLH, TLF (except TLF9UA) : Withstanding voltage : No abnormality Insulation resistance : No abnormality
Test Method and Remarks	TLH, TLF : Temperature : $60 \pm 2^\circ\text{C}$ : $40 \pm 2^\circ\text{C}$ (※except TLF9U) Humidity : $90 \sim 95\%RH$ Duration : 500 hrs Recovery : At least 1hr of recovery under the standard removal from test chamber followed by the measurement within 2 hrs.	

17. Loading under damp heat						
Specified Value	TLH, TLF Type	Withstanding voltage : No abnormality Insulation resistance : No abnormality				
Test Method and Remarks	TLH, TLF : Temperature : $60 \pm 2^\circ\text{C}$ : $40 \pm 2^\circ\text{C}$ (※except TLF9U ) Humidity : $90 \sim 95\%RH$ Duration : 100 hrs : 500 hrs Apply rated current across windings (※except TLF9U ) Applied voltage : Apply the following specified voltage between windings. <table border="1" style="margin-left: 40px;"> <tr> <td>TLF9UA</td> <td>250VAC</td> </tr> <tr> <td>TLF9UB</td> <td>50VDC</td> </tr> </table> Recovery : At least 1hr of recovery under the standard removal from test chamber followed by the measurement within 2 hrs.		TLF9UA	250VAC	TLF9UB	50VDC
TLF9UA	250VAC					
TLF9UB	50VDC					

▶ This catalog contains the typical specification only due to the limitation of space. When you consider the purchase of our products, please check our specification. For details of each product (characteristics graph, reliability information, precautions for use, and so on), see our Web site (<http://www.ty-top.com/>).

18. Low temperature life test		
Specified Value	TLH, TLF Type	TLF9U : Inductance change : Within $\pm 15\%$ TLH, TLF (except TLF9U) : Withstanding voltage : No abnormality Insulation resistance : No abnormality
Test Method and Remarks	TLH, TLF : Temperature : $-25 \pm 2^\circ\text{C}$ : $-40 \pm 2^\circ\text{C}$ (※TLF•TLH) Duration : 500 hrs Recovery : At least 1hr of recovery under the standard removal from test chamber followed by the measurement within 2 hrs.	

19. High Temperature life test		
Specified Value	TLH, TLF Type	TLF9U : Inductance change : Within $\pm 15\%$ TLH, TLF (except TLF9U) : Withstanding voltage : No abnormality Insulation resistance : No abnormality
Test Method and Remarks	TLH, TLF : Temperature : $105 \pm 3^\circ\text{C}$ (※ TLF•TLH) Duration : 500 hrs Recovery : At least 1hr of recovery under the standard removal from test chamber followed by the measurement within 2 hrs.	

# LEADED COMMON MODE CHOKE COILS FOR DC AND SIGNAL LINES, LEADED COMMON MODE CHOKE COILS FOR AC LINES

## ■ PRECAUTIONS

1. Circuit Design	
Precautions	<ul style="list-style-type: none"> <li>◆Operating environment               <ol style="list-style-type: none"> <li>1. The products described in this specification are intended for use in general electronic equipment, (office supply equipment, telecommunications systems, measuring equipment, and household equipment). They are not intended for use in mission-critical equipment or systems requiring special quality and high reliability (traffic systems, safety equipment, aerospace systems, nuclear control systems and medical equipment including life-support systems) where product failure might result in loss of life, injury or damage. For such uses, contact TAIYO YUDEN Sales Department in advance.</li> </ol> </li> </ul>
2. PCB Design	
Precautions	<ul style="list-style-type: none"> <li>◆Design               <ol style="list-style-type: none"> <li>1. Please design insertion pitches as matching to that of leads of the component on PCBs.</li> </ol> </li> </ul>
Technical considerations	<ul style="list-style-type: none"> <li>◆Design               <ol style="list-style-type: none"> <li>1. When Inductors are mounted onto a PC board, hole dimensions on the board should match the lead pitch of the component, if not, it will cause breakage of the terminals or cracking of terminal roots covered with resin as excess stress travels through the terminal legs.</li> </ol> </li> </ul>
3. Soldering	
Precautions	<ul style="list-style-type: none"> <li>◆Wave soldering               <ol style="list-style-type: none"> <li>1. Please refer to the specifications in the catalog for a wave soldering.</li> <li>2. Do not immerse the entire inductor in the flux during the soldering operation.</li> </ol> </li> <li>◆Lead free soldering               <ol style="list-style-type: none"> <li>1. When using products with lead free soldering, we request to use them after confirming of adhesion, temperature of resistance to soldering heat, etc. sufficiently.</li> </ol> </li> <li>◆Recommended conditions for using a soldering iron               <ul style="list-style-type: none"> <li>• Put the soldering iron on the land-pattern.</li> <li>• Soldering iron's temperature – Below 350°C</li> <li>• Duration – 3 seconds or less</li> <li>• The soldering iron should not directly touch the product.</li> </ul> </li> </ul>
Technical considerations	<ul style="list-style-type: none"> <li>◆Lead free soldering               <ol style="list-style-type: none"> <li>1. If products are used beyond the range of the recommended conditions, heat stresses may deform the products, and consequently degrade the reliability of the products.</li> </ol> </li> <li>◆Recommended conditions for using a soldering iron               <p>If products are used beyond the range of the recommended conditions, heat stresses may deform the products, and consequently degrade the reliability of the products.</p> </li> </ul>
4. Cleaning	
Precautions	<ul style="list-style-type: none"> <li>◆Cleaning conditions               <ol style="list-style-type: none"> <li>1. TLF type                   <p>Please contact any of our offices for about a cleaning.</p> </li> </ol> </li> </ul>
5. Handling	
Precautions	<ul style="list-style-type: none"> <li>◆Handling               <ol style="list-style-type: none"> <li>1. Keep the product away from all magnets and magnetic objects.</li> </ol> </li> <li>◆Mechanical considerations               <ol style="list-style-type: none"> <li>1. Please do not give the product any excessive mechanical shocks.</li> <li>2. TLF type                   <p>Please do not add any shock or power to a product in transportation.</p> </li> </ol> </li> <li>◆Packing               <ol style="list-style-type: none"> <li>1. Please do not give the product any excessive mechanical shocks.                   <p>In loading, please pay attention to handling indication mentioned in a packing box (a loading direction / number of maximum loading / fragile item).</p> </li> </ol> </li> </ul>
Technical considerations	<ul style="list-style-type: none"> <li>◆Handling               <ol style="list-style-type: none"> <li>1. There is a case that a characteristic varies with magnetic influence.</li> </ol> </li> <li>◆Mechanical considerations               <ol style="list-style-type: none"> <li>1. There is a case to be damaged by a mechanical shock.</li> <li>2. TLF type                   <p>There is a case to be broken by a fall.</p> </li> </ol> </li> <li>◆Packing               <ol style="list-style-type: none"> <li>1. There is a case that a lead route turns at by a fall or an excessive shock.</li> </ol> </li> </ul>

▶ This catalog contains the typical specification only due to the limitation of space. When you consider the purchase of our products, please check our specification. For details of each product (characteristics graph, reliability information, precautions for use, and so on), see our Web site (<http://www.ty-top.com/>).

## 6. Storage conditions

Precautions	<p>◆Storage</p> <p>1. To maintain the solderability of terminal electrodes and to keep the packing material in good condition, temperature and humidity in the storage area should be controlled.</p> <ul style="list-style-type: none"><li>• Recommended conditions</li></ul> <p>Ambient temperature : 0~40°C Humidity : Below 70% RH</p> <p>The ambient temperature must be kept below 30°C. Even under ideal storage conditions, the solderability of electrodes decreases gradually, so the products should be mounted within one year from the time of delivery.</p> <p>In case of storage over 6 months, solderability shall be checked before actual usage.</p>
Technical considerations	<p>◆Storage</p> <p>1. Under a high temperature and humidity environment, problems such as reduced solderability caused by oxidation of terminal electrodes and deterioration of taping/packaging materials may take place.</p>

# Mouser Electronics

Authorized Distributor

Click to View Pricing, Inventory, Delivery & Lifecycle Information:

## Taiyo Yuden:

[TLF24HB1031R0K1](#) [TLF24HB1223R0K1](#) [TLF24HB1230R9K1](#) [TLF24HB1830R8K1](#) [TLF24HB2222R2K1](#)  
[TLF24HB2722R0K1](#) [TLF24HB2730R6K1](#) [TLF24HB3321R8K1](#) [TLF24HB3330R5K1](#) [TLF24HB3921R5K1](#)  
[TLF24HB5621R4K1](#) [TLF24HB6821R2K1](#) [TLF24HB8221R0K1](#) [TLF24HBH1031R0K1](#) [TLF24HBH1223R0K1](#)  
[TLF24HBH1230R9K1](#) [TLF24HBH1830R8K1](#) [TLF24HBH2222R2K1](#) [TLF24HBH2722R0K1](#) [TLF24HBH2730R6K1](#)  
[TLF24HBH3321R8K1](#) [TLF24HBH3330R5K1](#) [TLF24HBH3921R5K1](#) [TLF24HBH5621R4K1](#) [TLF24HBH6821R2K1](#)  
[TLF24HBH8221R0K1](#)