

4

3

2

1

THIS DRAWING IS UNPUBLISHED.

RELEASED FOR PUBLICATION

© COPYRIGHT

注記:

- 1. 適用コンタクト : 0-1123721-1
- 2. 嵌合相手製品型番 : □-1123723-□
□-1123724-□

NOTES:

- 1. APPLICABLE CONTACT P/N : 0-1123721-1
- 2. MATING CONN P/N: □-1123723-□
□-1123724-□
- 3. 7-1123722-□ MEET GWT(GLOW WIRE TEST)
750 DEGREE SPEC

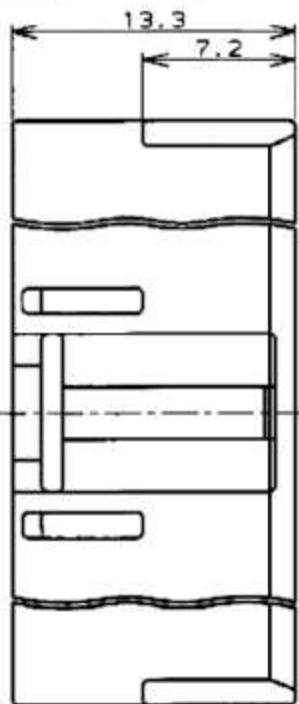

	41.10	43.50	39.60	■ 自然色 (NATURAL)	7-1123722-1	
				■ 緑 (GREEN)	6- - -1	
				■ 黒 (BLACK)	5- - -1	
				■ 赤 (RED)	4- - -1	
				■ 青 (BLUE)	3- - -1	
				■ 黄 (YELLOW)	2- - -1	
				■ 自然色 (NATURAL)	1- - -1	
7.50				■ 自然色 (NATURAL)	7- - -0	
				■ 緑 (GREEN)	6- - -0	
				■ 黒 (BLACK)	5- - -0	
				■ 赤 (RED)	4- - -0	
				■ 青 (BLUE)	3- - -0	
				■ 黄 (YELLOW)	2- - -0	
				■ 自然色 (NATURAL)	1- - -0	
	33.18	35.58	31.68	■ 自然色 (NATURAL)	9 7- - -9	
D	C	B	A	ハウジング色調 (HOUSING COLOR)	極数 (POS)	型番 (P/N)
寸法 (DIMENSION)						

	33.18	35.58	31.68	■ 緑 (GREEN)	6- - -9	
				■ 黒 (BLACK)	5- - -9	
				■ 赤 (RED)	4- - -9	
				■ 青 (BLUE)	3- - -9	
				■ 黄 (YELLOW)	2- - -9	
				■ 自然色 (NATURAL)	1- - -9	
				■ 自然色 (NATURAL)	7- - -8	
				■ 緑 (GREEN)	6- - -8	
				■ 黒 (BLACK)	5- - -8	
				■ 赤 (RED)	4- - -8	
				■ 青 (BLUE)	3- - -8	
				■ 黄 (YELLOW)	2- - -8	
				■ 自然色 (NATURAL)	1- - -8	
29.22	31.62	27.72		■ 自然色 (NATURAL)	7- - -7	
				■ 緑 (GREEN)	6- - -7	
				■ 黒 (BLACK)	5- - -7	
				■ 赤 (RED)	4- - -7	
				■ 青 (BLUE)	3- - -7	
				■ 黄 (YELLOW)	2- - -7	
				■ 自然色 (NATURAL)	1- - -7	
				■ 自然色 (NATURAL)	7- - -6	
				■ 緑 (GREEN)	6- - -6	
				■ 黒 (BLACK)	5- - -6	
				■ 赤 (RED)	4- - -6	
				■ 青 (BLUE)	3- - -6	
				■ 黄 (YELLOW)	2- - -6	
				■ 自然色 (NATURAL)	1- - -6	
				■ 自然色 (NATURAL)	7- - -5	
				■ 緑 (GREEN)	6- - -5	
				■ 黒 (BLACK)	5- - -5	
				■ 赤 (RED)	4- - -5	
				■ 青 (BLUE)	3- - -5	
				■ 黄 (YELLOW)	2- - -5	
				■ 自然色 (NATURAL)	1- - -5	
				■ 自然色 (NATURAL)	7- - -4	
				■ 緑 (GREEN)	6- - -4	
				■ 黒 (BLACK)	5- - -4	
				■ 赤 (RED)	4- - -4	
				■ 青 (BLUE)	3- - -4	
				■ 黄 (YELLOW)	2- - -4	
				■ 自然色 (NATURAL)	1- - -4	
				■ 自然色 (NATURAL)	7- - -3	
				■ 緑 (GREEN)	6- - -3	
				■ 黒 (BLACK)	5- - -3	
				■ 赤 (RED)	4- - -3	
				■ 青 (BLUE)	3- - -3	
				■ 黄 (YELLOW)	2- - -3	
				■ 自然色 (NATURAL)	1- - -3	
				■ 自然色 (NATURAL)	7- - -2	
				■ 緑 (GREEN)	6- - -2	
				■ 黒 (BLACK)	5- - -2	
				■ 赤 (RED)	4- - -2	
				■ 青 (BLUE)	3- - -2	
				■ 黄 (YELLOW)	2- - -2	
				■ 自然色 (NATURAL)	1-1123722-2	
	3.60	5.46	7.86	3.96		
D	C	B	A	ハウジング色調 (HOUSING COLOR)	極数 (POS)	型番 (P/N)
寸法 (DIMENSION)						

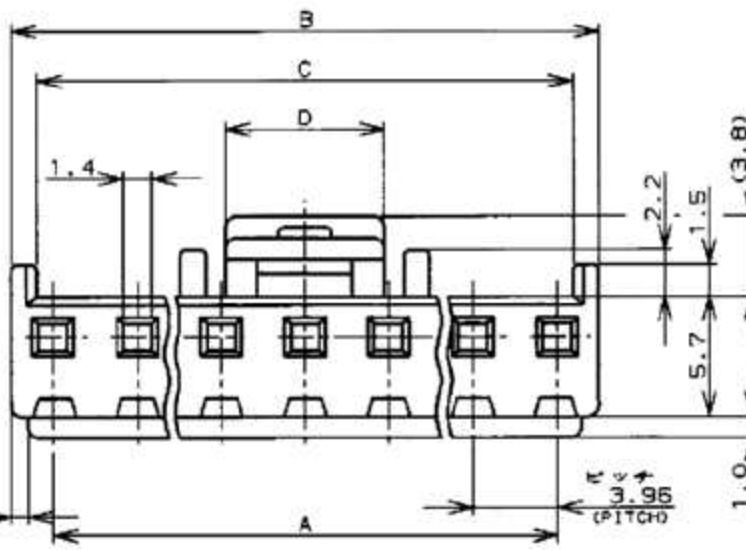
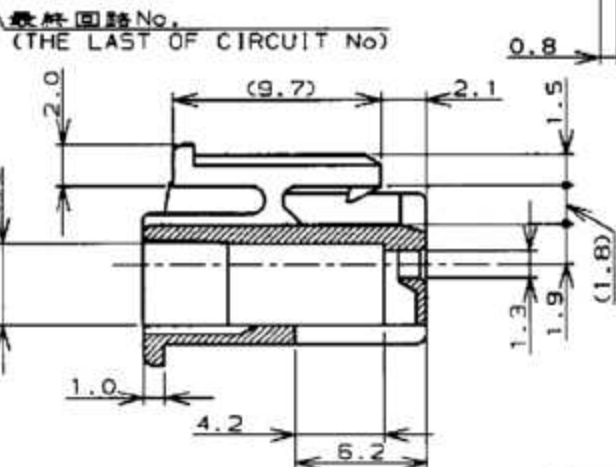
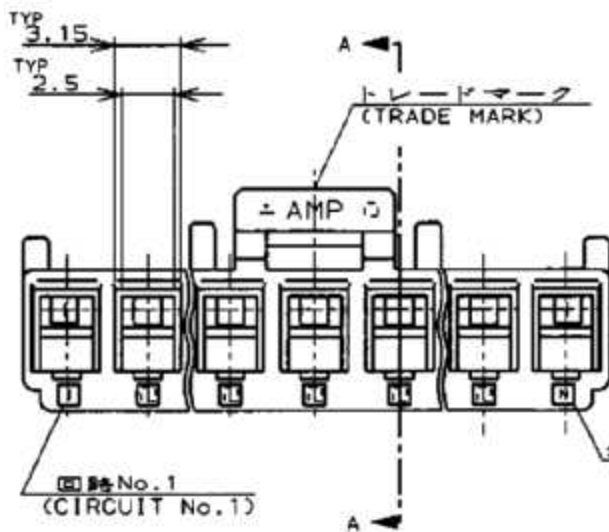

REV	DATE	BY	CHK	DESCRIPTION
D1	14JUN12	A.Z	F.M	REVISED PER ECR-12-010630
D	11APR12	L.L	F.M	REVISED PER ECR-12-006506
C1	21MAR11	RK	HMR	REVISED PER ECO-11-005030

DIMENSIONS: 単位・種 mm		TOLERANCES UNLESS OTHERWISE SPECIFIED			
				N.YAMASAKI M.SHINDO M.SHINDO	
MATERIAL: 66ナイロン UL94V-0 (66NYLON UL94V-0)		FINISH: 仕上		PRODUCT SPEC: 108-5609 APPLICATION SPEC: //	
WEIGHT: //		SCALE: //		3.96mm PITCH ECONOMY POWER (EP) CONN. PLUG HSG 3.96mm ピッチエコノミーパワー (EP) コネクタ プラグハウジング	
CUSTOMER DRAWING		SIZE: A3		CAGE CODE: 00779 DRAWING NO: 1123722	
		SHEET 1 OF 1		REV D1	

参考図面

Mouser Electronics

Authorized Distributor

Click to View Pricing, Inventory, Delivery & Lifecycle Information:

[TE Connectivity:](#)

[2-1123722-4](#)