

SP3002 Series 0.85pF Diode Array

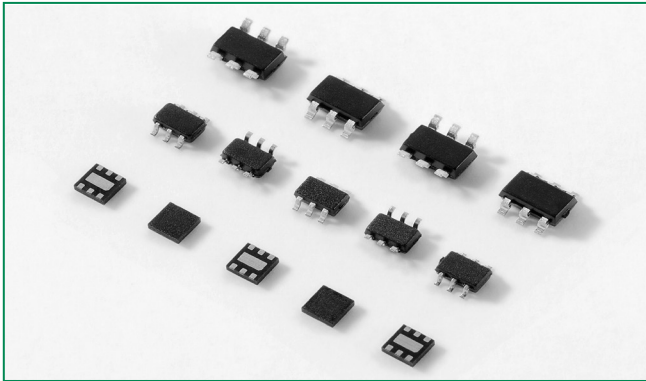

**Description**

The SP3002 has ultra low capacitance rail-to-rail diodes with an additional zener diode fabricated in a proprietary silicon avalanche technology to protect each I/O pin providing a high level of protection for electronic equipment that may experience destructive electrostatic discharges (ESD). These robust diodes can safely absorb repetitive ESD strikes at the maximum level (Level 4) specified in the IEC 61000-4-2 international standard without performance degradation. Their very low loading capacitance also makes them ideal for protecting high speed signal pins such as HDMI, DVI, USB2.0, and IEEE 1394.

**Pinout**

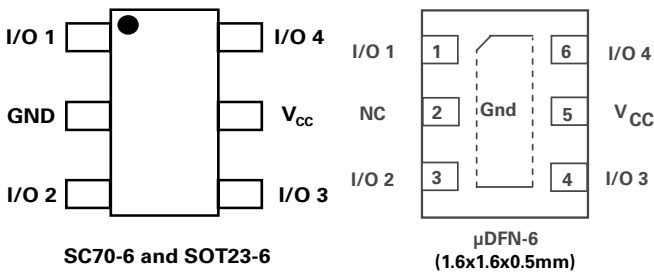

**Features**

- Low capacitance of 0.85 pF (TYP) per I/O
- ESD protection of ±12kV contact discharge, ±15kV air discharge, (IEC 61000-4-2)
- EFT protection, IEC 61000-4-4, 40A (5/50ns)
- Low leakage current of 0.5µA (MAX) at 5V
- Small packaging options saves board space
- Lightning Protection, IEC 61000-4-5, 2nd edition 4.5A (8/20µs)
- RoHS compliant and lead-free

**Functional Block Diagram**

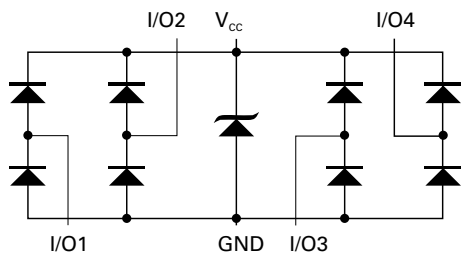

**Applications**

- Computer Peripherals
- Mobile Phones
- PDA's
- Digital Cameras
- Network Hardware/Ports
- Test Equipment
- Medical Equipment

**Application Example**

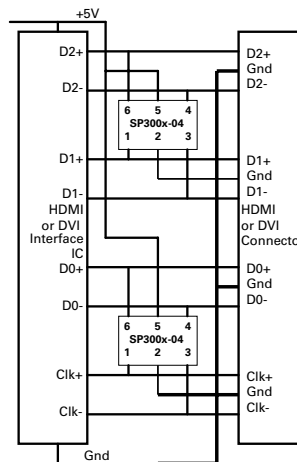

A single 4 channel SP300x-04 device can be used to protect four of the data lines in a HDMI/DVI interface. Two (2) SP300x-04 devices provide protection for the main data lines. Low voltage ASIC HDMI/DVI drivers can also be protected with the SP300x-04, the +V<sub>CC</sub> pins on the SP300x-04 can be substituted with a suitable bypass capacitor or in some backdrive applications the +V<sub>CC</sub> of the SP300x-04 can be floated or NC.

**Additional Information**



Resources

Samples

Life Support Note:

**Not intended for Use in Life Support or Life Saving Applications**

The products shown herein are not designed for use in life sustaining or life saving applications unless otherwise expressly indicated.

### Absolute Maximum Ratings

Symbol	Parameter	Value	Units
$I_{PP}$	Peak Current ( $t_p=8/20\mu s$ )	4.5	A
$T_{OP}$	Operating Temperature	-40 to 125	°C
$T_{STOR}$	Storage Temperature	-55 to 150	°C

CAUTION: Stresses above those listed in "Absolute Maximum Ratings" may cause permanent damage to the device. This is a stress only rating and operation of the device at these or any other conditions above those indicated in the operational sections of this specification is not implied.

### Thermal Information

Parameter	Rating	Units
Storage Temperature Range	-55 to 150	°C
Maximum Junction Temperature	150	°C
Maximum Lead Temperature (Soldering 20-40s)	260	°C

### Electrical Characteristics ( $T_{OP}=25^\circ C$ )

Parameter	Symbol	Test Conditions	Min	Typ	Max	Units
Reverse Standoff Voltage	$V_{RWM}$	$I_R \leq 1\mu A$			6.0	V
Reverse Leakage Current	$I_{LEAK}$	$V_R=5V$			0.5	$\mu A$
Clamp Voltage <sup>1</sup>	$V_C$	$I_{pp}=1A, t_p=8/20\mu s, Fwd$		9.5	11.0	V
		$I_{pp}=2A, t_p=8/20\mu s, Fwd$		10.6	13.0	V
ESD Withstand Voltage <sup>1</sup>	$V_{ESD}$	IEC61000-4-2 (Contact)	$\pm 12$			kV
		IEC61000-4-2 (Air)	$\pm 15$			kV
Diode Capacitance <sup>1</sup>	$C_{I/O-GND}$	Reverse Bias=0V	0.95	1.1	1.25	pF
		Reverse Bias=1.65V	0.7	0.85	1.0	pF
Diode Capacitance <sup>1</sup>	$C_{I/O-I/O}$	Reverse Bias=0V		0.5		pF

Note: 1. Parameter is guaranteed by design and/or device characterization.

### Insertion Loss (S21) I/O to GND

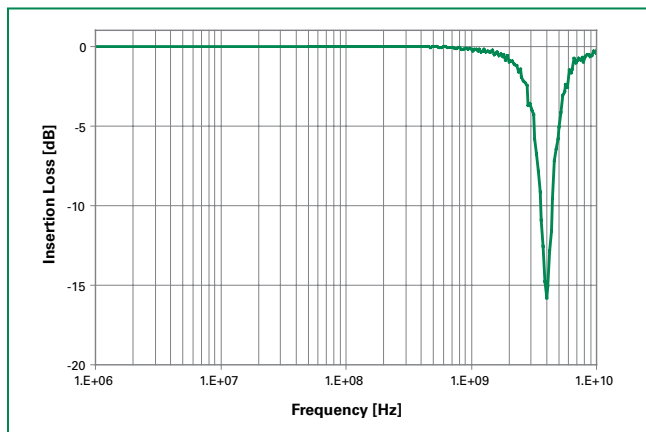

### Capacitance vs. Bias Voltage

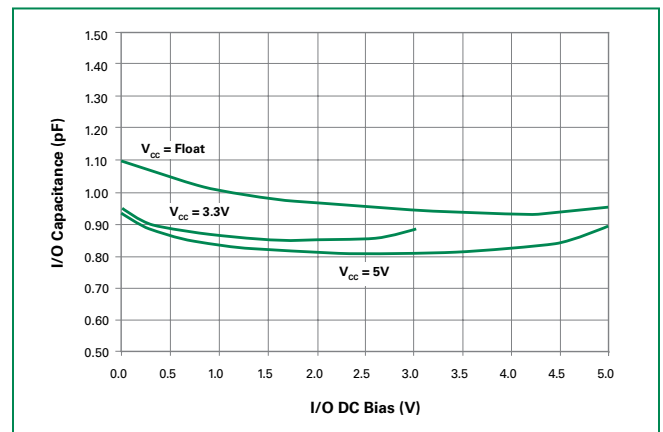

### Capacitance vs. Frequency

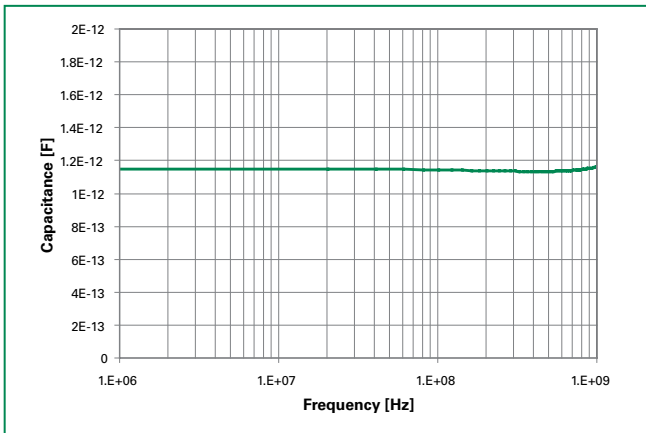

### Product Characteristics

<b>Lead Plating</b>	SC70 & SOT23: Matte Tin μDFN: Pre-Plated Frame
<b>Lead Material</b>	Copper Alloy
<b>Lead Coplanarity</b>	0.0004 inches (0.102mm)
<b>Substitute Material</b>	Silicon
<b>Body Material</b>	Molded Epoxy
<b>Flammability</b>	UL 94 V-0

Notes :

1. All dimensions are in millimeters
2. Dimensions include solder plating.
3. Dimensions are exclusive of mold flash & metal burr.
4. Blo is facing up for mold and facing down for trim/form, i.e. reverse trim/form.
5. Package surface matte finish VDI 11-13.

### Soldering Parameters

Reflow Condition	Pb – Free assembly	
Pre Heat	- Temperature Min ( $T_{s(min)}$ )	150°C
	- Temperature Max ( $T_{s(max)}$ )	200°C
	- Time (min to max) ( $t_s$ )	60 – 180 secs
Average ramp up rate (Liquidus) Temp ( $T_L$ ) to peak	3°C/second max	
$T_{s(max)}$ to $T_L$ - Ramp-up Rate	3°C/second max	
Reflow	- Temperature ( $T_L$ ) (Liquidus)	217°C
	- Temperature ( $t_l$ )	60 – 150 seconds
Peak Temperature ( $T_p$ )	260 <sup>+0/-5</sup> °C	
Time within 5°C of actual peak Temperature ( $t_p$ )	20 – 40 seconds	
Ramp-down Rate	6°C/second max	
Time 25°C to peak Temperature ( $T_p$ )	8 minutes Max.	
Do not exceed	260°C	

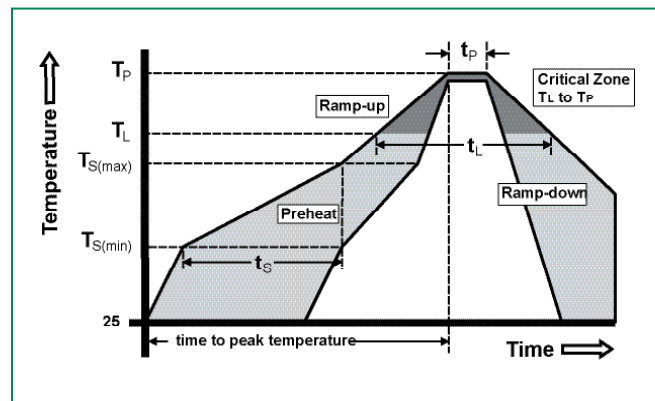

**Package Dimensions — SC70-6**

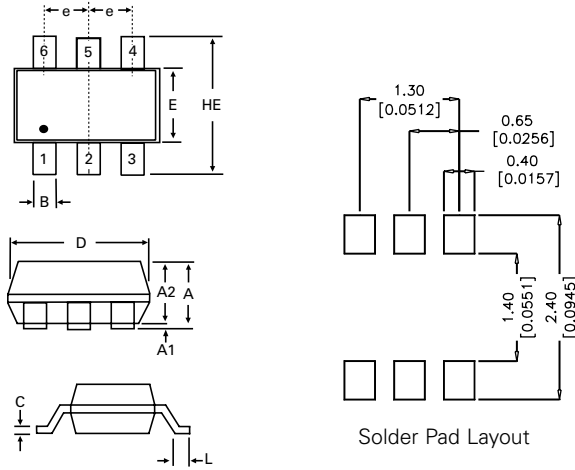

Package	SC70-6			
Pins	6			
JEDEC	MO-203			
	Millimeters		Inches	
	Min	Max	Min	Max
<b>A</b>	0.80	1.10	0.031	0.043
<b>A1</b>	0.00	0.10	0.000	0.004
<b>A2</b>	0.70	1.00	0.028	0.039
<b>B</b>	0.15	0.30	0.006	0.012
<b>c</b>	0.08	0.25	0.003	0.010
<b>D</b>	1.85	2.25	0.073	0.089
<b>E</b>	1.15	1.35	0.045	0.053
<b>e</b>	0.65 BSC		0.026 BSC	
<b>HE</b>	2.00	2.40	0.079	0.094
<b>L</b>	0.26	0.46	0.010	0.018

**Package Dimensions — SOT23-6**

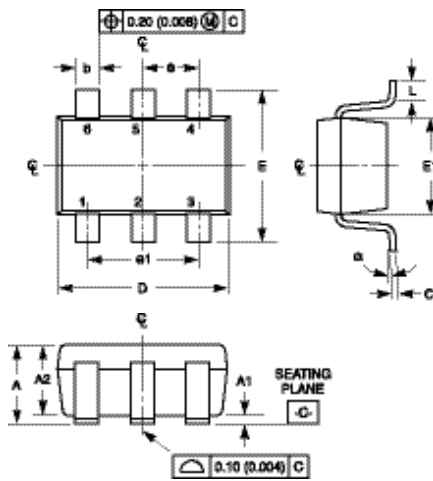

**Recommended Solder Pad Layout**

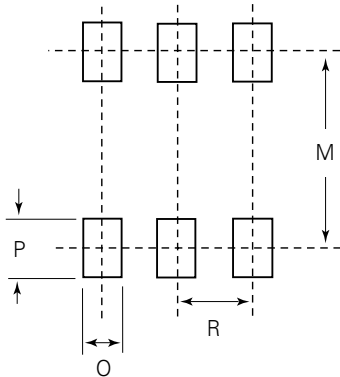

Package	SOT23-6				Notes
Pins	6				
JEDEC	MO-178				
	Millimeters		Inches		
	Min	Max	Min	Max	
<b>A</b>	0.900	1.450	0.035	0.057	-
<b>A1</b>	0.000	0.150	0.000	0.006	-
<b>A2</b>	0.900	1.300	0.035	0.051	-
<b>b</b>	0.350	0.500	0.0138	0.0196	-
<b>C</b>	0.080	0.220	0.0031	0.009	-
<b>D</b>	2.800	3.000	0.11	0.118	3
<b>E</b>	2.600	3.000	0.102	0.118	-
<b>E1</b>	1.500	1.750	0.06	0.069	3
<b>e</b>	0.95 Ref		0.0374 Ref		-
<b>e1</b>	1.9 Ref		0.0748 Ref		-
<b>L</b>	0.100	0.600	0.004	0.023	4,5
<b>N</b>	6		6		6
<b>a</b>	0°	10°	0°	10°	-
<b>M</b>			2.590	0.102	-
<b>O</b>			0.690	.027 TYP	-
<b>P</b>			0.990	.039 TYP	-
<b>R</b>			0.950	0.038	-

- Notes:
1. Dimensioning and tolerances per ANSI 14.5M-1982.
  2. Package conforms to EIAJ SC-74 (1992).
  3. Dimensions D and E1 are exclusive of mold flash, protrusions, or gate burrs.
  4. Footlength L measured at reference to seating plane.
  5. "L" is the length of flat foot surface for soldering to substrate.
  6. "N" is the number of terminal positions.
  7. Controlling dimension: MILLIMETER. Converted inch dimensions are not necessarily exact.

**Package Dimensions —  $\mu$ DFN-6 (1.6x1.6x0.5mm)**

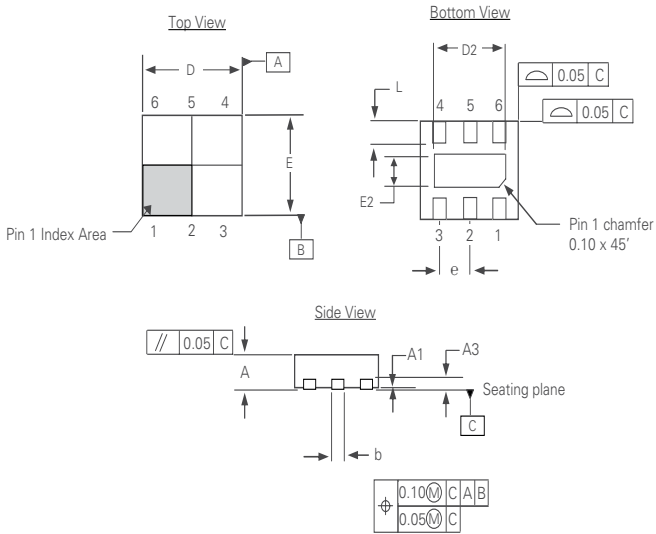

Package	$\mu$ DFN-6 (1.6x1.6x0.5mm)			
JEDEC	MO-229			
Symbol	Millimeters		Inches	
	Min	Max	Min	Max
<b>A</b>	0.45	0.55	0.018	0.022
<b>A1</b>	0.00	0.05	0.000	0.002
<b>A3</b>	0.127 Ref		0.005 Ref	
<b>b</b>	0.20	0.30	0.008	0.012
<b>D</b>	1.50	1.70	0.060	0.067
<b>D2</b>	1.05	1.30	0.042	0.052
<b>E</b>	1.50	1.70	0.060	0.067
<b>E2</b>	0.40	0.65	0.016	0.026
<b>e</b>	0.50 Ref		0.020 Ref	
<b>L</b>	0.25	0.40	0.010	0.016

**Part Numbering System**

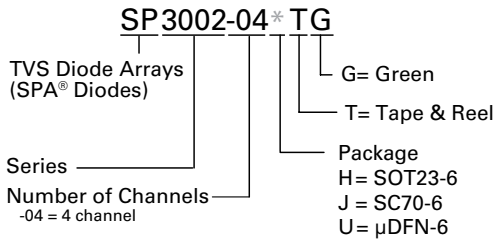

**Ordering Information**

Part Number	Package	Marking	Min. Order Qty.
SP3002-04HTG	SOT23-6	E * 4	3000
SP3002-04JTG	SC70-6	E * 4	3000
SP3002-04UTG	$\mu$ DFN-6 (1.6x1.6x0.5mm)	E * 4	3000

**Part Marking System**

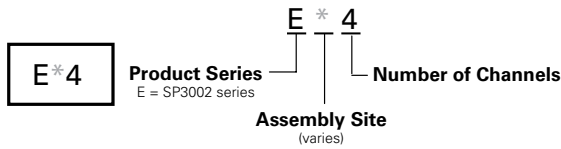

**Embossed Carrier Tape & Reel Specification – SC70-6**

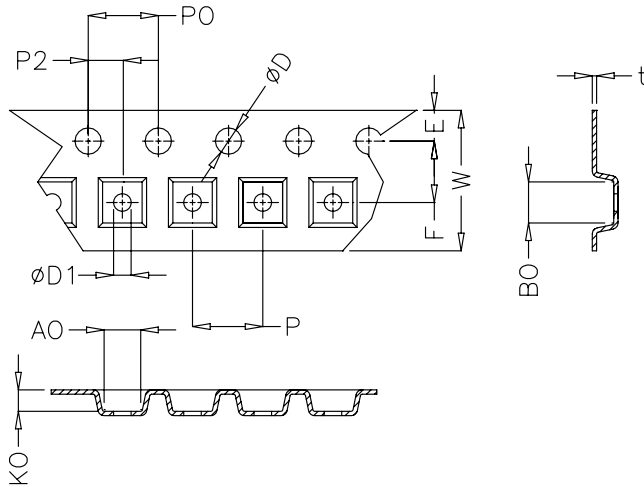

Symbol	Millimetres		Inches	
	Min	Max	Min	Max
<b>E</b>	1.65	1.85	0.064	0.073
<b>F</b>	3.45	3.55	0.135	0.139
<b>P2</b>	1.95	2.05	0.077	0.081
<b>D</b>	1.40	1.60	0.055	0.063
<b>D1</b>	1.00	1.25	0.039	0.049
<b>P0</b>	3.90	4.10	0.154	0.161
<b>10P0</b>	40.0± 0.20		1.574±0.008	
<b>W</b>	7.70	8.10	0.303	0.318
<b>P</b>	3.90	4.10	0.153	0.161
<b>A0</b>	2.14	2.34	0.084	0.092
<b>B0</b>	2.24	2.44	0.088	0.096
<b>K0</b>	1.12	1.32	0.044	0.052
<b>t</b>	0.27 Max		0.010 Max	

**Embossed Carrier Tape & Reel Specification – SOT23-6**

8mm TAPE AND REEL

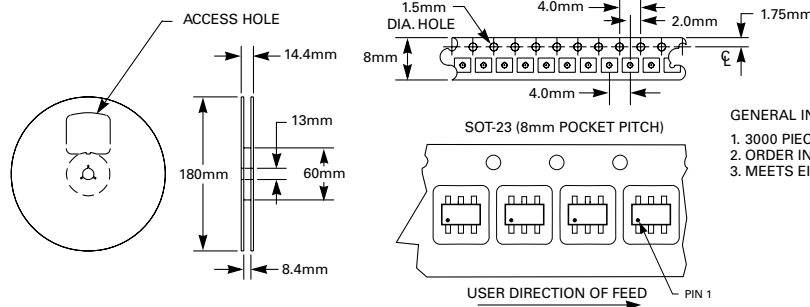

- GENERAL INFORMATION
- 3000 PIECES PER REEL.
  - ORDER IN MULTIPLES OF FULL REELS ONLY.
  - MEETS EIA-481 REVISION "A" SPECIFICATIONS.

**Embossed Carrier Tape & Reel Specification – µDFN-6 (1.6x1.6x0.5mm)**

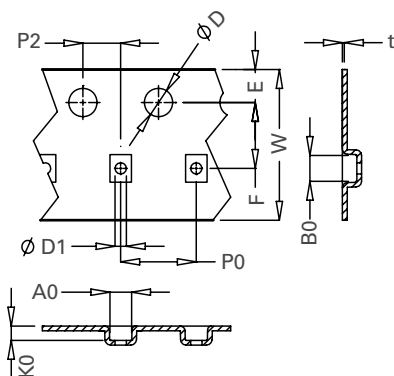

Symbol	Millimetres		Inches	
	Min	Max	Min	Max
<b>E</b>	1.65	1.85	0.06	0.07
<b>F</b>	3.45	3.55	0.14	0.14
<b>D1</b>	1.00	1.25	0.04	0.05
<b>D</b>	1.50 MIN		0.06 MIN	
<b>P0</b>	3.90	4.10	0.15	0.16
<b>10P0</b>	40.0± 0.20		1.57±0.01	
<b>W</b>	7.90	8.30	0.31	0.33
<b>P2</b>	1.95	2.05	0.08	0.08
<b>A0</b>	1.78	1.88	0.07	0.07
<b>B0</b>	1.78	1.88	0.07	0.07
<b>K0</b>	0.84	0.94	0.03	0.04
<b>t</b>	0.25 TYP		0.01 TYP	

**Disclaimer Notice - Information furnished is believed to be accurate and reliable. However, users should independently evaluate the suitability of and test each product selected for their own applications. Littelfuse products are not designed for, and may not be used in, all applications. Read complete Disclaimer Notice at [www.littelfuse.com/disclaimer-electronics](http://www.littelfuse.com/disclaimer-electronics).**