

TPA2026D2 3.2-W/Ch Stereo Class-D Audio Amplifier With Fast Gain Ramp SmartGain™ Automatic Gain Control and Dynamic Range Compression

1 Features

- Fast AGC Start-Up Time: 5 ms
- Pinout Compatible With TPA2016D2
- Filter-Free Class-D Architecture
- 3.2 W/Ch Into 4 Ω at 5 V (10% THD+N)
- 750 mW/Ch Into 8 Ω at 3.6 V (10% THD+N)
- Power Supply Range: 2.5 V to 5.5 V
- Flexible Operation With or Without I²C
- Programmable DRC and AGC Parameters
- Digital I²C Volume Control
- Selectable Gain from 0 dB to 30 dB in 1-dB Steps
- Selectable Attack, Release, and Hold Times
- 4 Selectable Compression Ratios
- Low Supply Current: 3.5 mA
- Low Shutdown Current: 0.2 μ A
- High PSRR: 80 dB
- AGC Enable or Disable Function
- Limiter Enable or Disable Function
- Short-Circuit and Thermal Protection
- Space-Saving Package
 - 2.2 mm x 2.2 mm Nano-Free™ DSBGA (YZH)

2 Applications

- Wireless or Cellular Handsets and PDAs
- Portable Navigation Devices
- Portable DVD Players
- Notebook PCs
- Portable Radios
- Portable Games
- Educational Toys
- USB Speakers

3 Description

The TPA2026D2 device is a stereo, filter-free Class-D audio power amplifier with volume control, dynamic range compression (DRC), and automatic gain control (AGC). It is available in a 2.2 mm x 2.2 mm DSBGA package.

The DRC and AGC function in the TPA2026D2 is programmable through a digital I²C interface. The DRC and AGC function can be configured to automatically prevent distortion of the audio signal and enhance quiet passages that are normally not heard. The DRC and AGC can also be configured to protect the speaker from damage at high power levels and compress the dynamic range of music to fit within the dynamic range of the speaker. The gain can be selected from 0 dB to +30 dB in 1-dB steps. The TPA2026D2 is capable of driving 3.2 W/Ch at 5 V into an 4- Ω load or 750 mW/Ch at 3.6 V into an 8- Ω load. The device features independent software shutdown controls for each channel and also provides thermal and short-circuit protection. The TPA2026D2 has faster AGC gain ramp during start-up than TPA2016D2.

In addition to these features, a fast start-up time and small package size make the TPA2026D2 an ideal choice for cellular handsets, PDAs, and other portable applications.

Device Information⁽¹⁾

PART NUMBER	PACKAGE	BODY SIZE (NOM)
TPA2026D2	DSBGA (16)	2.20 mm x 2.20 mm

(1) For all available packages, see the orderable addendum at the end of the data sheet.

Simplified Application Diagram

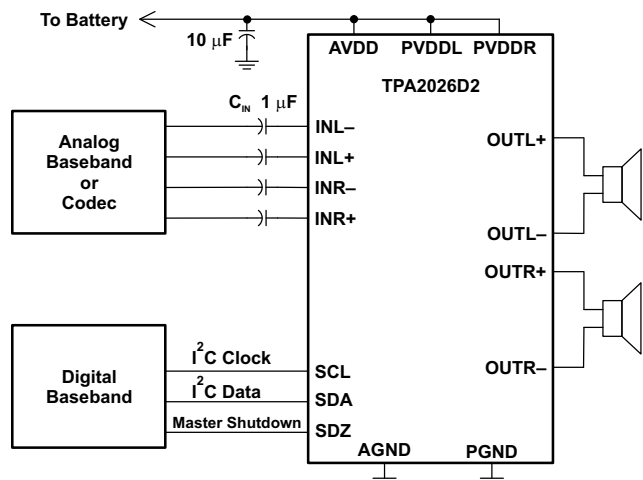

Copyright © 2016, Texas Instruments Incorporated



Table of Contents

<p>1 Features 1</p> <p>2 Applications 1</p> <p>3 Description 1</p> <p>4 Revision History..... 2</p> <p>5 Device Comparison Table..... 3</p> <p>6 Pin Configuration and Functions 3</p> <p>7 Specifications..... 4</p> <p> 7.1 Absolute Maximum Ratings 4</p> <p> 7.2 ESD Ratings..... 4</p> <p> 7.3 Recommended Operating Conditions..... 4</p> <p> 7.4 Thermal Information 4</p> <p> 7.5 Electrical Characteristics..... 5</p> <p> 7.6 I²C Timing Requirements..... 5</p> <p> 7.7 Dissipation Ratings 5</p> <p> 7.8 Operating Characteristics..... 6</p> <p> 7.9 Typical Characteristics..... 7</p> <p>8 Parameter Measurement Information 12</p> <p>9 Detailed Description 13</p> <p> 9.1 Overview 13</p> <p> 9.2 Functional Block Diagram 13</p> <p> 9.3 Feature Description..... 13</p>	<p> 9.4 Device Functional Modes..... 22</p> <p> 9.5 Programming 23</p> <p> 9.6 Register Maps 25</p> <p>10 Application and Implementation..... 30</p> <p> 10.1 Application Information..... 30</p> <p> 10.2 Typical Applications 30</p> <p>11 Power Supply Recommendations 33</p> <p> 11.1 Power Supply Decoupling Capacitors 33</p> <p>12 Layout..... 33</p> <p> 12.1 Layout Guidelines 33</p> <p> 12.2 Layout Example 35</p> <p> 12.3 Efficiency and Thermal Considerations 35</p> <p>13 Device and Documentation Support 36</p> <p> 13.1 Device Support..... 36</p> <p> 13.2 Community Resources..... 36</p> <p> 13.3 Trademarks 36</p> <p> 13.4 Electrostatic Discharge Caution..... 36</p> <p> 13.5 Glossary 36</p> <p>14 Mechanical, Packaging, and Orderable Information 36</p> <p> 14.1 YZH Package Dimensions 36</p>
---	--

4 Revision History

NOTE: Page numbers for previous revisions may differ from page numbers in the current version.

Changes from Revision A (January 2011) to Revision B	Page
<ul style="list-style-type: none"> • Added <i>ESD Ratings</i> table, <i>Feature Description</i> section, <i>Device Functional Modes</i>, <i>Application and Implementation</i> section, <i>Power Supply Recommendations</i> section, <i>Layout</i> section, <i>Device and Documentation Support</i> section, and <i>Mechanical, Packaging, and Orderable Information</i> section. 	1

Changes from Original (March 2010) to Revision A	Page
<ul style="list-style-type: none"> • Changed the Default values in Table 5 	26
<ul style="list-style-type: none"> • Changed the Default value of the IC Function Control Table (I²C BIT 0) From: 0 (disabled) To: 1 (enabled) 	26

5 Device Comparison Table

DEVICE NUMBER	SPEAKER AMP TYPE	SPECIAL FEATURE	OUTPUT POWER (W)	PSRR (dB)
TPA2012D2	Class D	—	2.1	71
TPA2016D2	Class D	AGC/DRC	2.8	80
TPA2026D2	Class D	AGC/DRC	3.2	80

6 Pin Configuration and Functions

YZH Package
16-Pin DSBGA
Top View

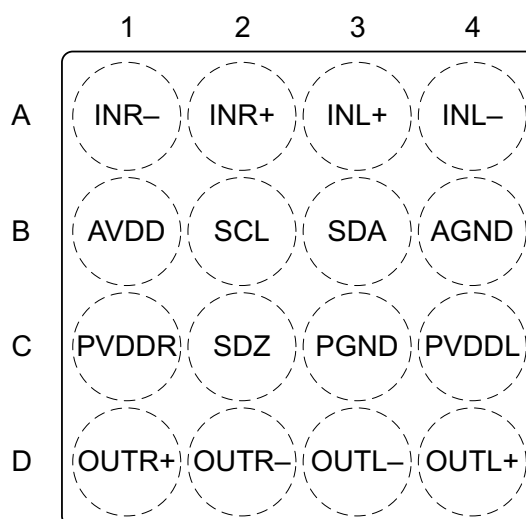

Pin Functions

PIN		TYPE	DESCRIPTION
NO.	NAME		
A1	INR-	I	Right channel negative audio input
A2	INR+	I	Right channel positive audio input
A3	INL+	I	Left channel positive audio input
A4	INL-	I	Left channel negative audio input
B1	AVDD	P	Analog supply (must be the same as PVDDR and PVDDL)
B2	SCL	I	I ² C clock interface
B3	SDA	I/O	I ² C data interface
B4	AGND	P	Analog ground (all GND pins need to be connected)
C1	PVDDR	P	Right channel power supply (must be the same as AVDD and PVDDL)
C2	SDZ	I	Shutdown terminal (active low)
C3	PGND	P	Power ground (all GND pins need to be connected)
C4	PVDDL	P	Left channel power supply (must be the same as AVDD and PVDDR)
D1	OUTR+	O	Right channel positive differential output
D2	OUTR-	O	Right channel negative differential output
D3	OUTL-	O	Left channel negative differential output
D4	OUTL+	O	Left channel positive differential output

7 Specifications

7.1 Absolute Maximum Ratings⁽¹⁾

over operating free-air temperature range (unless otherwise noted).

			MIN	MAX	UNIT
V _{DD}	Supply voltage	AVDD, PVDDR, PVDDL	-0.3	6	V
	Input voltage	SDZ, INR+, INR-, INL+, INL-	-0.3	V _{DD} + 0.3	V
		SDA, SCL	-0.3	6	
	Continuous total power dissipation		See Dissipation Ratings		
R _L	Minimum load resistance			3.2	Ω
T _A	Operating free-air temperature		-40	85	°C
T _J	Operating junction temperature		-40	150	°C
T _{stg}	Storage temperature		-65	150	°C

- (1) Stresses beyond those listed under *Absolute Maximum Ratings* may cause permanent damage to the device. These are stress ratings only, which do not imply functional operation of the device at these or any other conditions beyond those indicated under *Recommended Operating Conditions*. Exposure to absolute-maximum-rated conditions for extended periods may affect device reliability.

7.2 ESD Ratings

			VALUE	UNIT
V _(ESD)	Electrostatic discharge	Human-body model (HBM), per ANSI/ESDA/JEDEC JS-001 ⁽¹⁾	±2000	V
		Charged-device model (CDM), per JEDEC specification JESD22-C101 ⁽²⁾	±500	

- (1) JEDEC document JEP155 states that 500-V HBM allows safe manufacturing with a standard ESD control process.
 (2) JEDEC document JEP157 states that 250-V CDM allows safe manufacturing with a standard ESD control process.

7.3 Recommended Operating Conditions

			MIN	MAX	UNIT
V _{DD}	Supply voltage	AVDD, PVDDR, PVDDL	2.5	5.5	V
V _{IH}	High-level input voltage	SDZ, SDA, SCL	1.3		V
V _{IL}	Low-level input voltage	SDZ, SDA, SCL		0.6	V
T _A	Operating free-air temperature		-40	+85	°C

7.4 Thermal Information

THERMAL METRIC ⁽¹⁾		TPA2026D2	UNIT
		YZH (DSBGA)	
		16 PINS	
R _{θJA}	Junction-to-ambient thermal resistance	71	°C/W
R _{θJC(top)}	Junction-to-case (top) thermal resistance	0.4	°C/W
R _{θJB}	Junction-to-board thermal resistance	14.4	°C/W
ψ _{JT}	Junction-to-top characterization parameter	1.9	°C/W
ψ _{JB}	Junction-to-board characterization parameter	13.6	°C/W
R _{θJC(bot)}	Junction-to-case (bottom) thermal resistance	—	°C/W

- (1) For more information about traditional and new thermal metrics, see the *Semiconductor and IC Package Thermal Metrics* application report, [SPRA953](#).

7.5 Electrical Characteristics

at $T_A = 25^\circ\text{C}$, $V_{DD} = 3.6\text{ V}$, $SDZ = 1.3\text{ V}$, and $R_L = 8\ \Omega + 33\ \mu\text{H}$ (unless otherwise noted).

PARAMETER		TEST CONDITIONS	MIN	TYP	MAX	UNIT
V_{DD}	Supply voltage range		2.5	3.6	5.5	V
I_{SDZ}	Shutdown quiescent current	$SDZ = 0.35\text{ V}$, $V_{DD} = 2.5\text{ V}$		0.1	1	μA
		$SDZ = 0.35\text{ V}$, $V_{DD} = 3.6\text{ V}$		0.2	1	
		$SDZ = 0.35\text{ V}$, $V_{DD} = 5.5\text{ V}$		0.3	1	
I_{SWS}	Software shutdown quiescent current	$SDZ = 1.3\text{ V}$, $V_{DD} = 2.5\text{ V}$		35	50	μA
		$SDZ = 1.3\text{ V}$, $V_{DD} = 3.6\text{ V}$		50	70	
		$SDZ = 1.3\text{ V}$, $V_{DD} = 5.5\text{ V}$		75	110	
I_{DD}	Supply current	$V_{DD} = 2.5\text{ V}$		3.5	4.5	mA
		$V_{DD} = 3.6\text{ V}$		3.7	4.7	
		$V_{DD} = 5.5\text{ V}$		4.5	5.5	
f_{SW}	Class-D switching frequency		275	300	325	kHz
I_{IH}	High-level input current	$V_{DD} = 5.5\text{ V}$, $SDZ = 5.8\text{ V}$			1	μA
I_{IL}	Low-level input current	$V_{DD} = 5.5\text{ V}$, $SDZ = -0.3\text{ V}$	-1			μA
t_{START}	Start-up time	$2.5\text{ V} \leq V_{DD} \leq 5.5\text{ V}$ no pop, $C_{IN} \leq 1\ \mu\text{F}$		5		ms
POR	Power on reset ON threshold			2	2.3	V
POR	Power on reset hysteresis			0.2		V
CMRR	Input common-mode rejection	$R_L = 8\ \Omega$, $V_{icm} = 0.5\text{ V}$ and $V_{icm} = V_{DD} - 0.8\text{ V}$, differential inputs shorted		-70		dB
V_{oo}	Output offset voltage	$V_{DD} = 3.6\text{ V}$, $A_V = 6\text{ dB}$, $R_L = 8\ \Omega$, inputs AC grounded		2	10	mV
Z_{OUT}	Output impedance in shutdown mode	$SDZ = 0.35\text{ V}$		2		k Ω
	Gain accuracy	Compression and limiter disabled, Gain = 0 to 30 dB	-0.5		0.5	dB
PSRR	Power supply rejection ratio	$V_{DD} = 2.5\text{ V}$ to 4.7 V		-80		dB

7.6 I²C Timing Requirements

For I²C Interface Signals Over Recommended Operating Conditions (unless otherwise noted)

		MIN	TYP	MAX	UNIT
f_{SCL}	Frequency, SCL	No wait states		400	kHz
$t_{W(H)}$	Pulse duration, SCL high	0.6			μs
$t_{W(L)}$	Pulse duration, SCL low	1.3			μs
$t_{SU(1)}$	Setup time, SDA to SCL	100			ns
t_{h1}	Hold time, SCL to SDA	10			ns
$t_{(buf)}$	Bus free time between stop and start condition	1.3			μs
t_{SU2}	Setup time, SCL to start condition	0.6			μs
t_{h2}	Hold time, start condition to SCL	0.6			μs
t_{SU3}	Setup time, SCL to stop condition	0.6			μs

7.7 Dissipation Ratings

PACKAGE	$T_A \leq 25^\circ\text{C}$	DERATING FACTOR	$T_A = 70^\circ\text{C}$	$T_A = 85^\circ\text{C}$
16-ball WCSP ⁽¹⁾	1.25 W	10 mW/ $^\circ\text{C}$	0.8 W	0.65 W

(1) Dissipations ratings are for a 2-side, 2-plane PCB.

7.8 Operating Characteristics

at $T_A = 25^\circ\text{C}$, $V_{DD} = 3.6\text{V}$, $SDZ = 1.3\text{V}$, $R_L = 8\ \Omega + 33\ \mu\text{H}$, and $A_v = 6\text{ dB}$ (unless otherwise noted).

			MIN	TYP	MAX	UNIT
k_{SVR}	Power-supply ripple rejection ratio	$V_{DD} = 3.6\text{ Vdc}$ with AC of 200 mV_{PP} at 217 Hz		-68		dB
THD+N	Total harmonic distortion + noise	$f_{aud_in} = 1\text{ kHz}$, $P_O = 550\text{ mW}$, $V_{DD} = 3.6\text{ V}$		0.1%		
		$f_{aud_in} = 1\text{ kHz}$, $P_O = 1\text{ W}$, $V_{DD} = 5\text{ V}$		0.1%		
		$f_{aud_in} = 1\text{ kHz}$, $P_O = 630\text{ mW}$, $V_{DD} = 3.6\text{ V}$		1%		
		$f_{aud_in} = 1\text{ kHz}$, $P_O = 1.4\text{ W}$, $V_{DD} = 5\text{ V}$		1%		
$N_{fo_{nF}}$	Output integrated noise	$A_v = 6\text{ dB}$		44		μV
N_{fo_A}	Output integrated noise	$A_v = 6\text{ dB floor}$, A-weighted		33		μV
FR	Frequency response	$A_v = 6\text{ dB}$	20		20000	Hz
P_{Omax}	Maximum output power	THD+N = 10%, $V_{DD} = 5\text{ V}$, $R_L = 8\ \Omega$		1.72		W
		THD+N = 10%, $V_{DD} = 3.6\text{ V}$, $R_L = 8\ \Omega$		750		mW
		THD+N = 1%, $V_{DD} = 5\text{ V}$, $R_L = 8\ \Omega$		1.4		W
		THD+N = 1%, $V_{DD} = 3.6\text{ V}$, $R_L = 8\ \Omega$		630		mW
η	Efficiency	THD+N = 1%, $V_{DD} = 3.6\text{ V}$, $R_L = 8\ \Omega$, $P_O = 0.63\text{ W}$		90%		
		THD+N = 1%, $V_{DD} = 5\text{ V}$, $R_L = 8\ \Omega$, $P_O = 1.4\text{ W}$		90%		

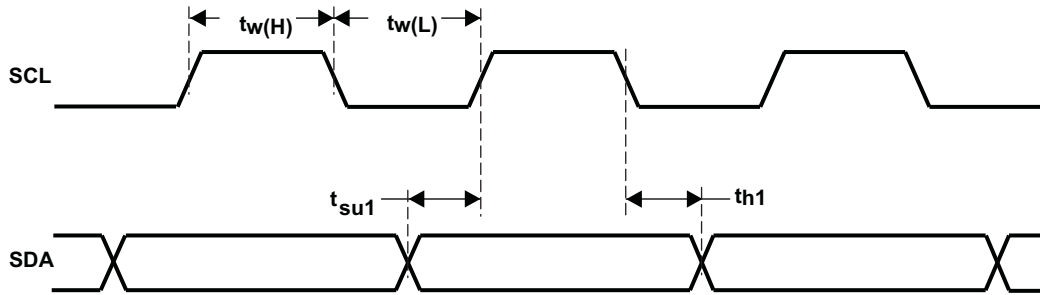

Figure 1. SCL and SDA Timing

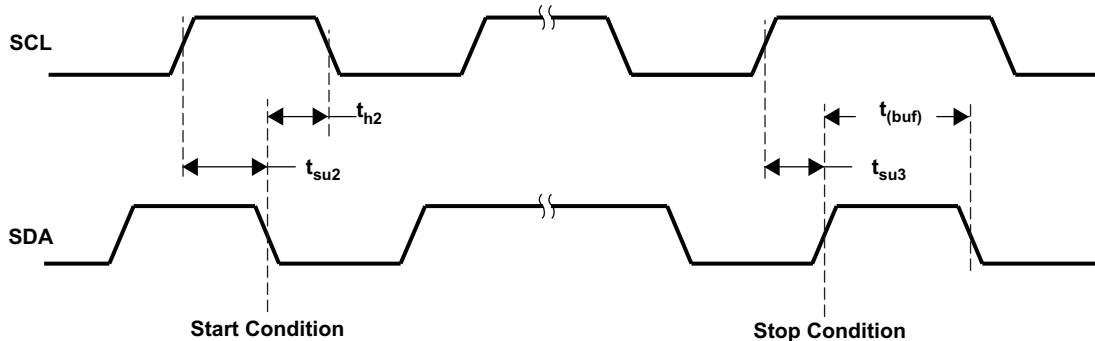

Figure 2. Start and Stop Conditions Timing

7.9 Typical Characteristics

with $C_{(DECOUPLE)} = 1 \mu\text{F}$, $C_I = 1 \mu\text{F}$. All THD + N graphs are taken with outputs out of phase (unless otherwise noted). All data is taken on left channel.

Table 1. Table of Graphs

		FIGURE
Quiescent supply current	vs Supply voltage	Figure 3
Supply current	vs Supply voltage in shutdown	Figure 4
Output level	vs Input level	Figure 5
Output level	vs Input level	Figure 6
Output level	vs Input level	Figure 7
Output level	vs Input level	Figure 8
Output level	vs Input level	Figure 9
Supply ripple rejection ratio	vs Frequency, 8 Ω	Figure 10
Total harmonic distortion + noise	vs Frequency $V_{\text{SUPPLY}} = 2.5 \text{ V}$, 4 Ω	Figure 11
Total harmonic distortion + noise	vs Frequency $V_{\text{SUPPLY}} = 2.5 \text{ V}$, 8 Ω	Figure 12
Total harmonic distortion + noise	vs Frequency $V_{\text{SUPPLY}} = 3.6 \text{ V}$, 4 Ω	Figure 13
Total harmonic distortion + noise	vs Frequency $V_{\text{SUPPLY}} = 3.6 \text{ V}$, 8 Ω	Figure 14
Total harmonic distortion + noise	vs Frequency $V_{\text{SUPPLY}} = 5 \text{ V}$, 4 Ω	Figure 15
Total harmonic distortion + noise	vs Frequency $V_{\text{SUPPLY}} = 5 \text{ V}$, 8 Ω	Figure 16
Total harmonic distortion + noise	vs Output power, 4 Ω	Figure 17
Total harmonic distortion + noise	vs Output power, 8 Ω	Figure 18
Efficiency	vs Output power (per channel), 4 Ω	Figure 19
Efficiency	vs Output power (per channel), 8 Ω	Figure 20
Total power dissipation	vs Total output power, 4 Ω	Figure 21
Total power dissipation	vs Total output power, 8 Ω	Figure 22
Total supply current	vs Total output power, 4 Ω	Figure 23
Total supply current	vs Total output power, 8 Ω	Figure 24
Output power	vs Supply voltage, 4 Ω	Figure 25
Output power	vs Supply voltage, 8 Ω	Figure 26
TPA2026D2	vs TPA2016D2 Start-up gain ramp	Figure 27
TPA2026D2	vs TPA2016D2 Shutdown gain ramp	Figure 28
Shutdown time		Figure 29
Start-up time		Figure 30

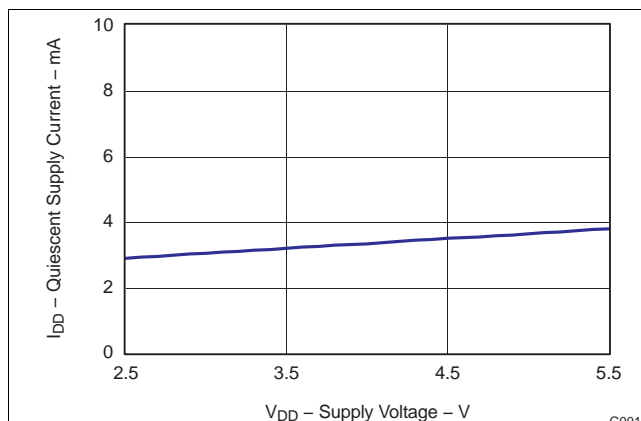
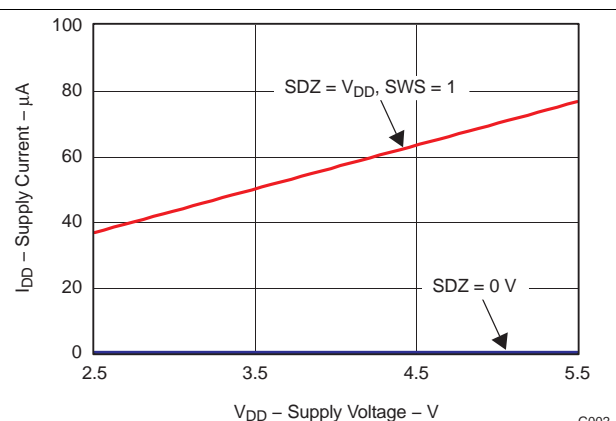
Figure 3. Quiescent Supply Current vs Supply Voltage

Figure 4. Supply Current Vs Supply Voltage in Shutdown

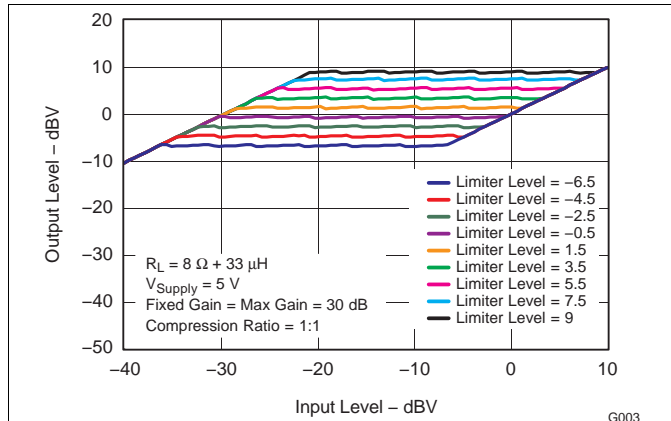

Figure 5. Output Level vs Input level With Limiter Enabled

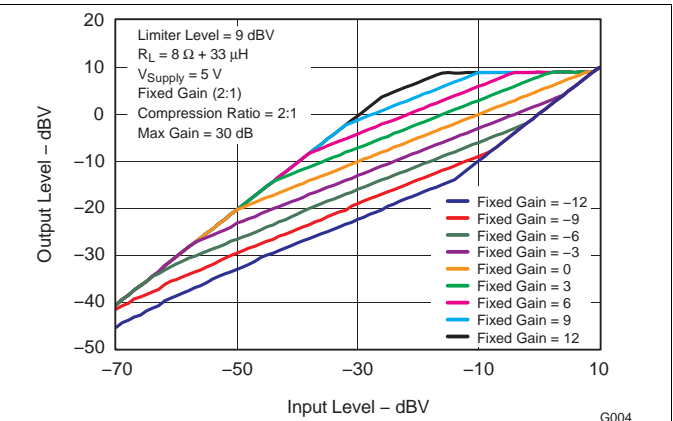

Figure 6. Output Level vs Input level With 2:1 Compression

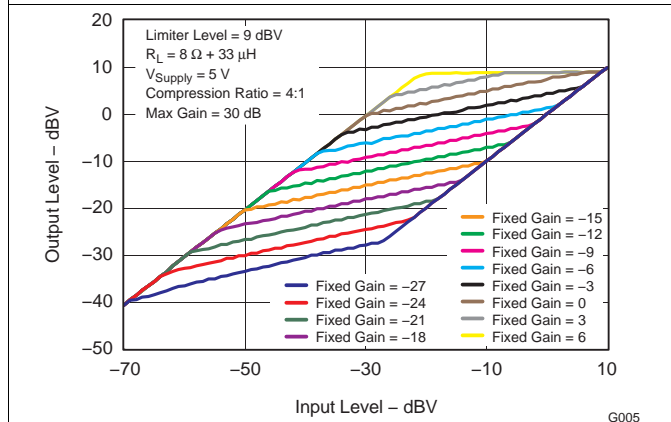

Figure 7. Output Level vs Input level With 4:1 Compression

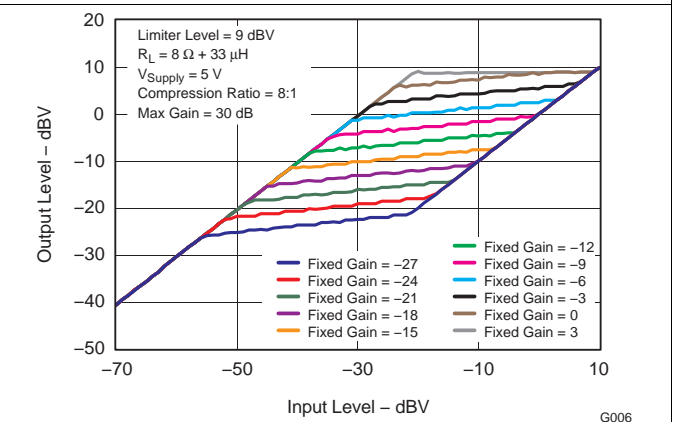

Figure 8. Output Level vs Input level With 8:1 Compression

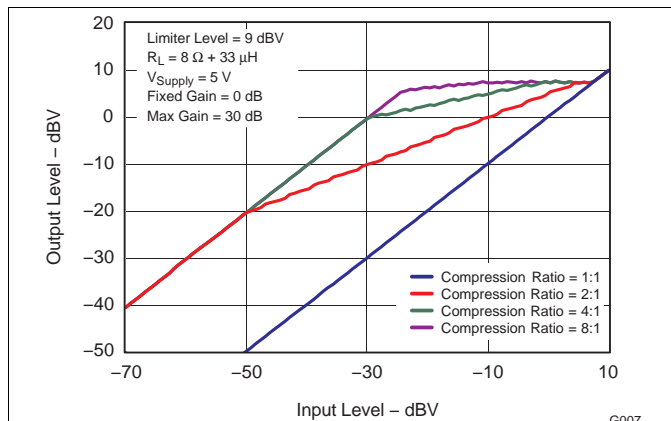

Figure 9. Output Level vs Input level

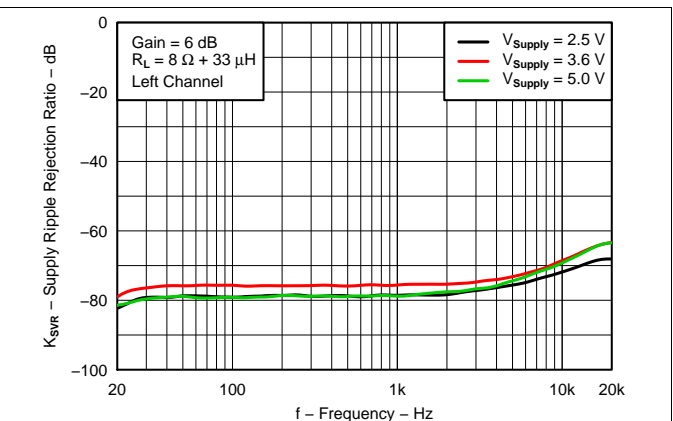

Figure 10. Supply Ripple Rejection Ratio vs Frequency, 8 Ω

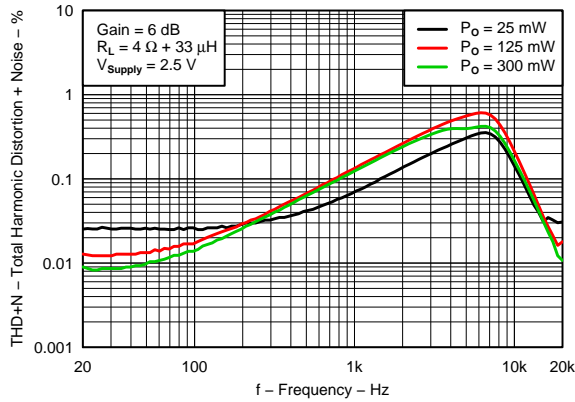

Figure 11. Total Harmonic Distortion + Noise vs Frequency
V_{SUPPLY} = 2.5 V, 4 Ω

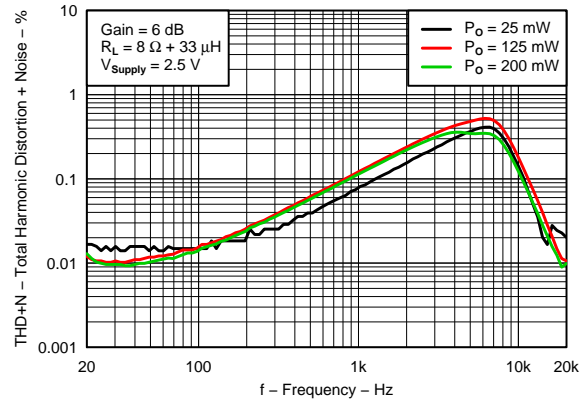

Figure 12. Total Harmonic Distortion + Noise vs Frequency
V_{SUPPLY} = 2.5 V, 8 Ω

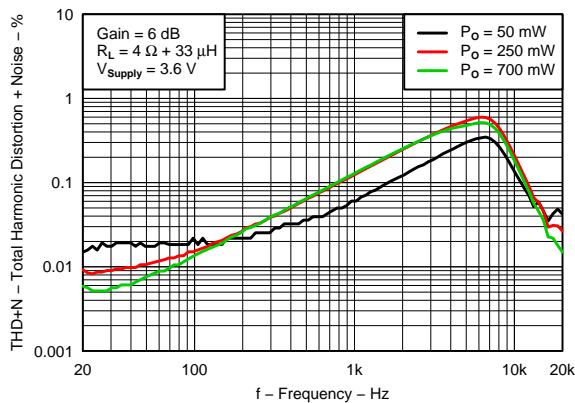

Figure 13. Total Harmonic Distortion + Noise vs Frequency
V_{SUPPLY} = 3.6 V, 4 Ω

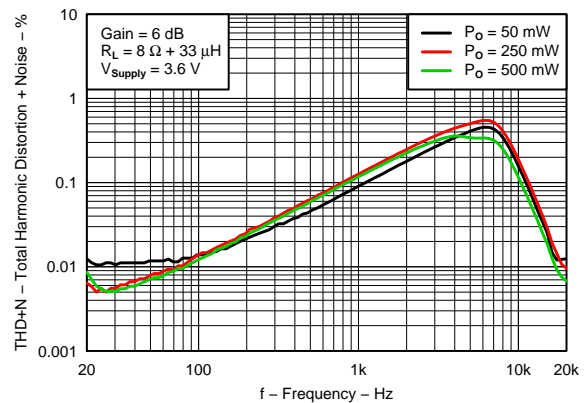

Figure 14. Total Harmonic Distortion + Noise vs Frequency
V_{SUPPLY} = 3.6 V, 8 Ω

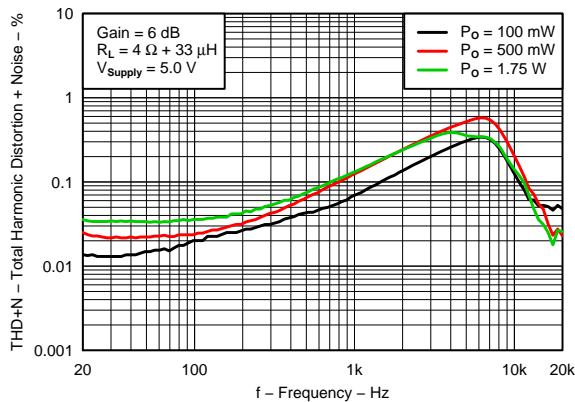

Figure 15. Total Harmonic Distortion + Noise vs Frequency
V_{SUPPLY} = 5 V, 4 Ω

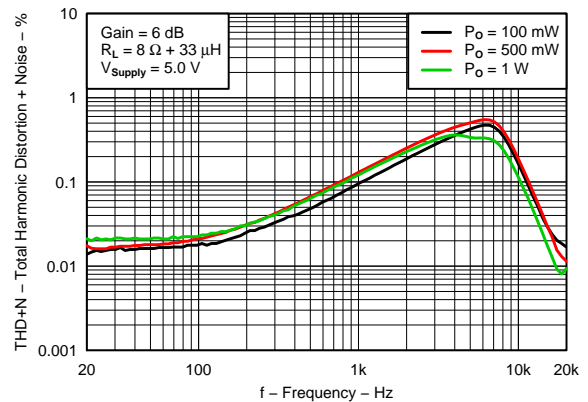

Figure 16. Total Harmonic Distortion + Noise vs Frequency
V_{SUPPLY} = 5 V, 8 Ω

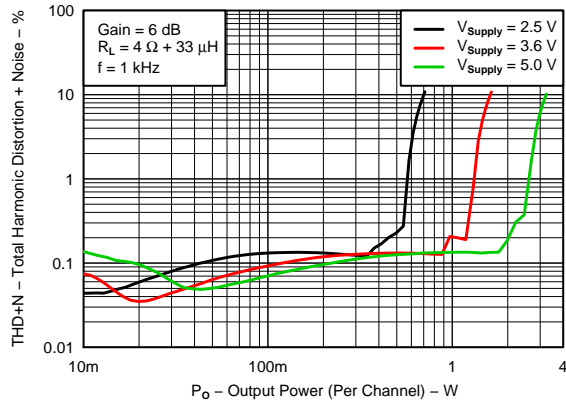

Figure 17. Total Harmonic Distortion + Noise vs Power, 4 Ω

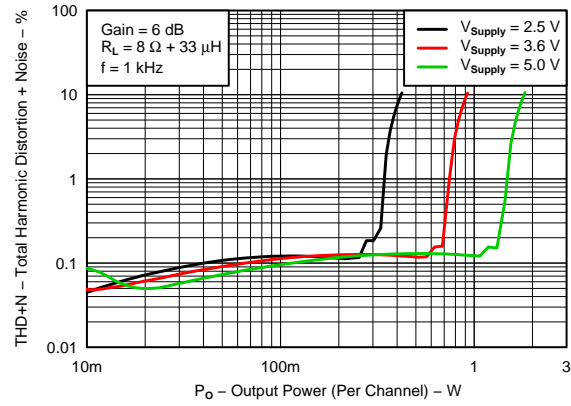

Figure 18. Total Harmonic Distortion + Noise vs Power, 8 Ω

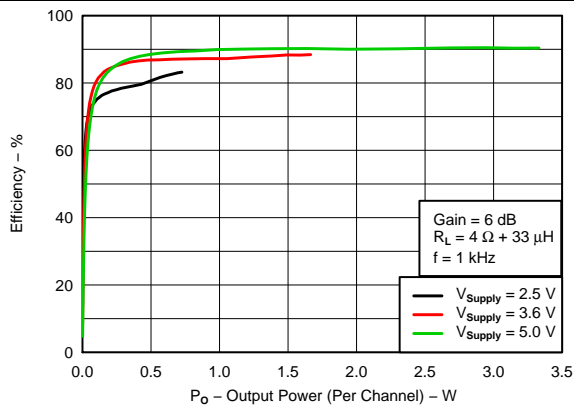

Figure 19. Efficiency vs Output Power (Per Channel), 4 Ω

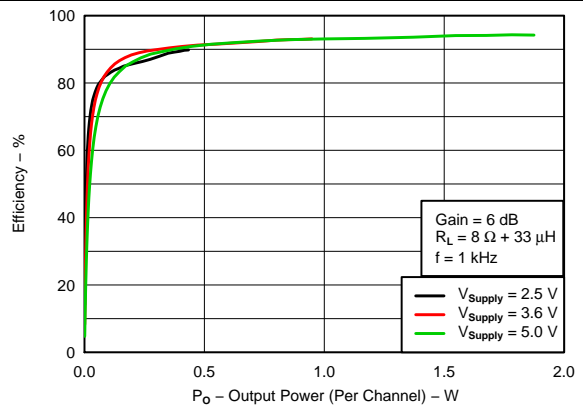

Figure 20. Efficiency vs Output Power (Per Channel), 8 Ω

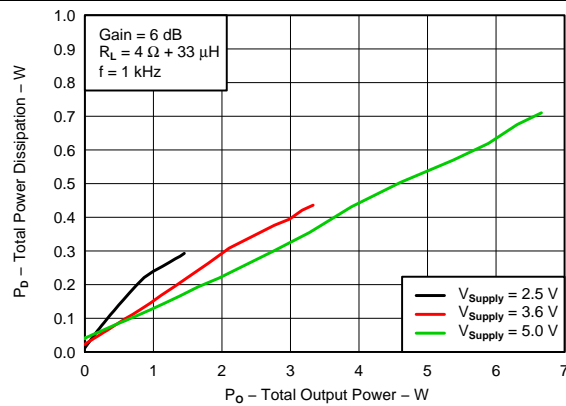

Figure 21. Total Power Dissipation vs Total Output Power, 4 Ω

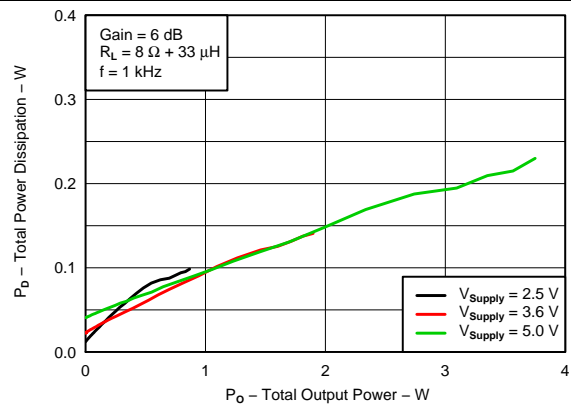

Figure 22. Total Power Dissipation vs Total Output Power, 8 Ω

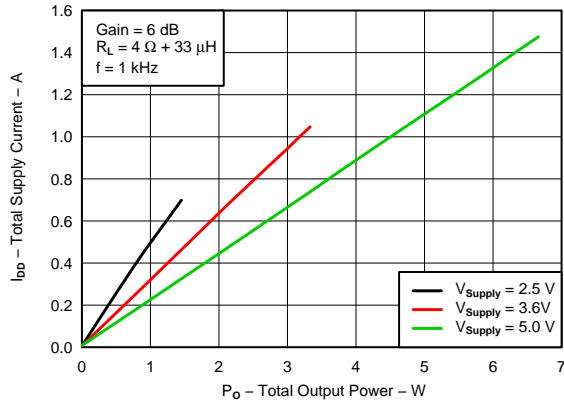

Figure 23. Total Supply Current vs Total Output Power, 4 Ω

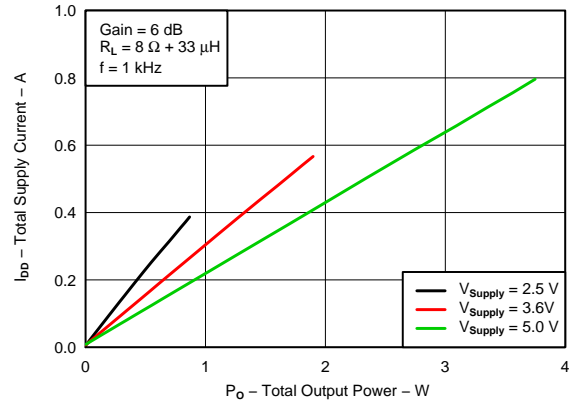

Figure 24. Total Supply Current vs Total Output Power, 8 Ω

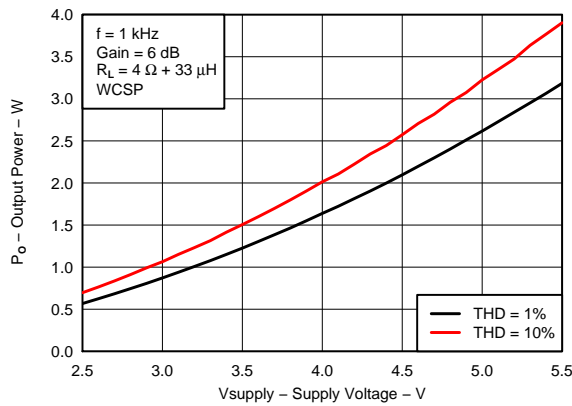

Figure 25. Output Power vs Supply Voltage, 4 Ω

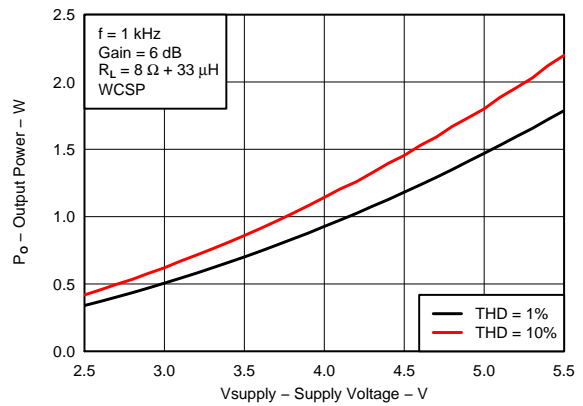

Figure 26. Output Power vs Supply Voltage, 8 Ω

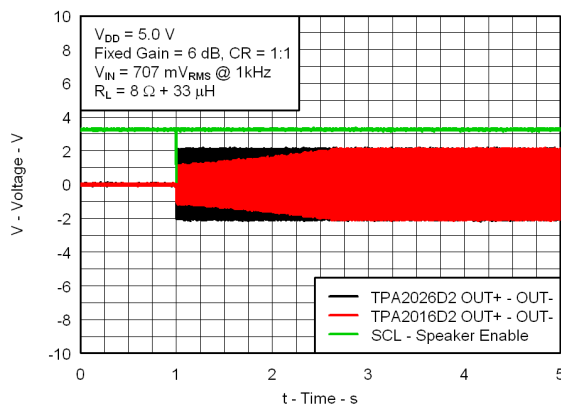

Figure 27. TPA2026D2 vs TPA2016D2 Start-Up Gain Ramp

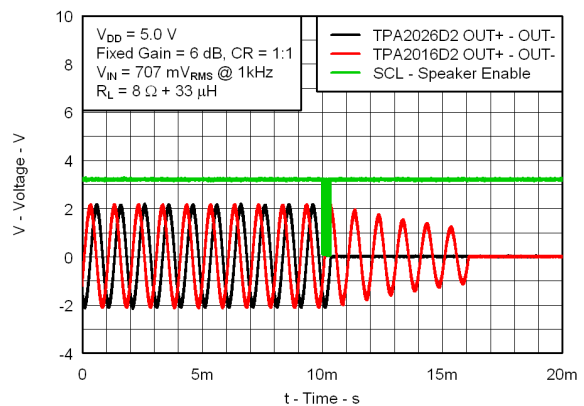

Figure 28. TPA2026D2 vs TPA2016D2 Shutdown Gain Ramp

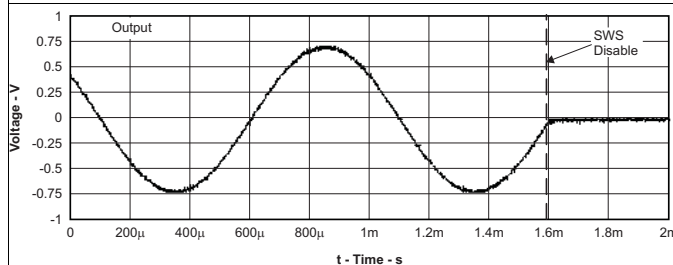

Figure 29. Shutdown Time

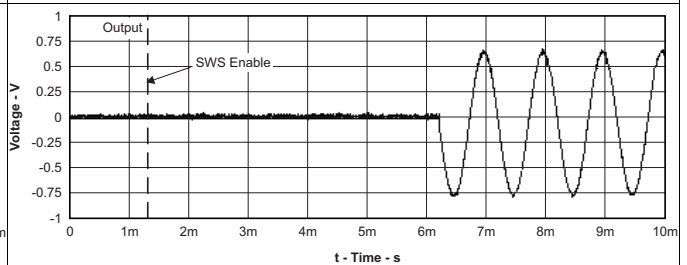
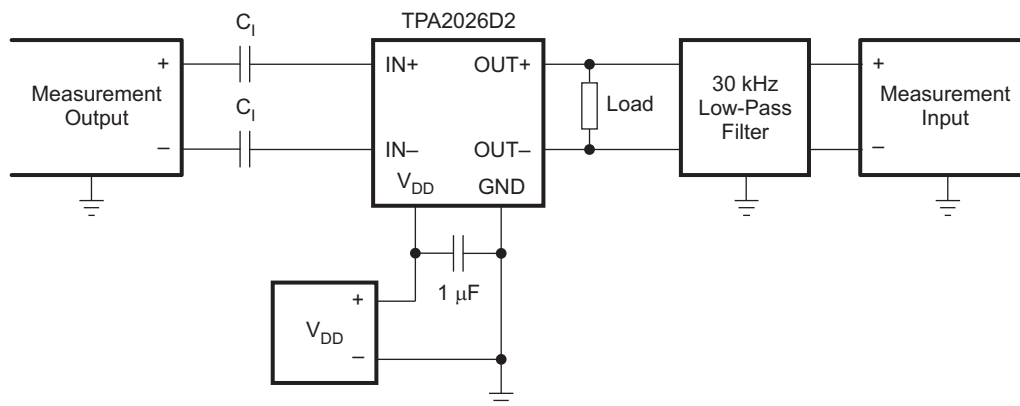

Figure 30. Start-Up Time

8 Parameter Measurement Information

All parameters are measured according to the conditions described in [Specifications](#). [Figure 31](#) shows the setup used for the typical characteristics of the test device.



- (1) All measurements were taken with a 1- μF C_1 (unless otherwise noted).
- (2) A 33- μH inductor was placed in series with the load resistor to emulate a small speaker for efficiency measurements.
- (3) The 30-kHz low-pass filter is required, even if the analyzer has an internal low-pass filter. An RC low-pass filter (1 k Ω 4.7 nF) is used on each output for the data sheet graphs.

Figure 31. Test Setup for Graphs

9 Detailed Description

9.1 Overview

The TPA2026D2 is a stereo Class-D audio power amplifier capable of driving 750 mW/Ch into 8-Ω load at 3.6 V and 3.2 W/Ch into 4-Ω load at 5 V. The device features independent software shutdown controls for each channel and also provides thermal and short-circuit protection. In addition to these features, a fast start-up time and small package size make the TPA2026D2 an ideal choice for cellular handsets, PDAs, and other portable applications.

9.2 Functional Block Diagram

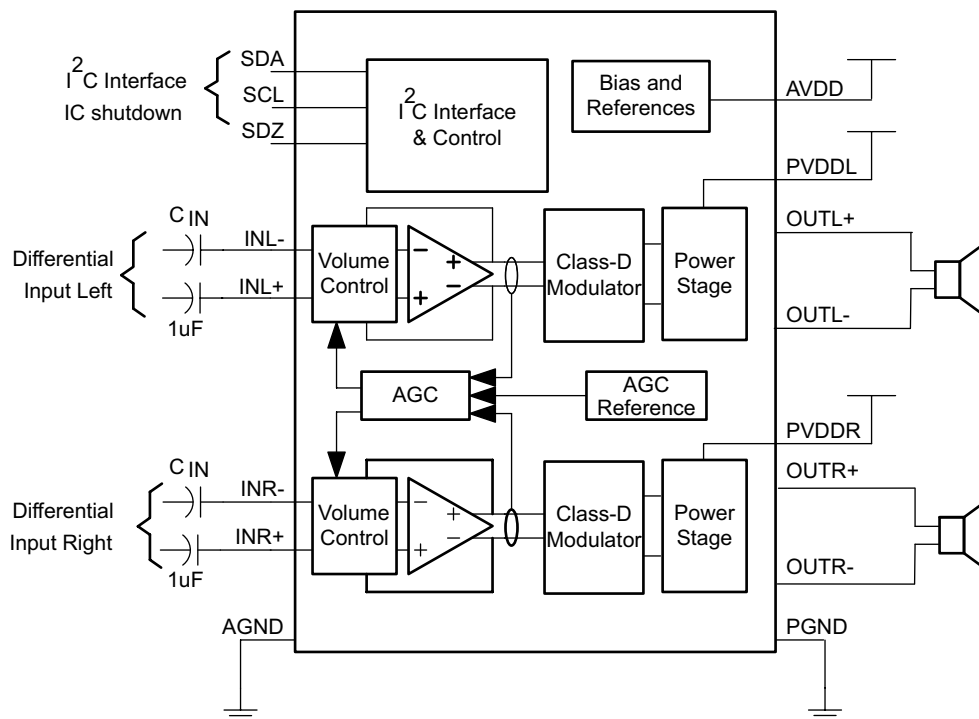

Copyright © 2016, Texas Instruments Incorporated

9.3 Feature Description

9.3.1 Automatic Gain Control

The Automatic Gain Control (AGC) feature provides continuous automatic gain adjustment to the amplifier through an internal PGA. This feature enhances the perceived audio loudness and at the same time prevents speaker damage from occurring (Limiter function).

The AGC function attempts to maintain the audio signal gain as selected by the user through the Fixed Gain, Limiter Level, and Compression Ratio variables. Other advanced features included are Maximum Gain and Noise Gate Threshold. [Table 2](#) describes the function of each variable in the AGC function.

Table 2. TPA2026D2 AGC Variable Descriptions

VARIABLE	DESCRIPTION
Maximum Gain	The gain at the lower end of the compression region.
Fixed Gain	The normal gain of the device when the AGC is inactive.
	The fixed gain is also the initial gain when the device comes out of shutdown mode or when the AGC is disabled.
Limiter Level	The value that sets the maximum allowed output amplitude.

Feature Description (continued)

Table 2. TPA2026D2 AGC Variable Descriptions (continued)

VARIABLE	DESCRIPTION
Compression Ratio	The relation between input and output voltage.
Noise Gate Threshold	Below this value, the AGC holds the gain to prevent breathing effects.
Attack Time	The minimum time between two gain decrements.
Release Time	The minimum time between two gain increments.
Hold Time	The time it takes for the very first gain increment after the input signal amplitude decreases.

The AGC works by detecting the audio input envelope. The gain changes depending on the amplitude, the limiter level, the compression ratio, and the attack and release time. The gain changes constantly as the audio signal increases and/or decreases to create the compression effect. The gain step size for the AGC is 0.5 dB. If the audio signal has near-constant amplitude, the gain does not change. Figure 32 shows how the AGC works.

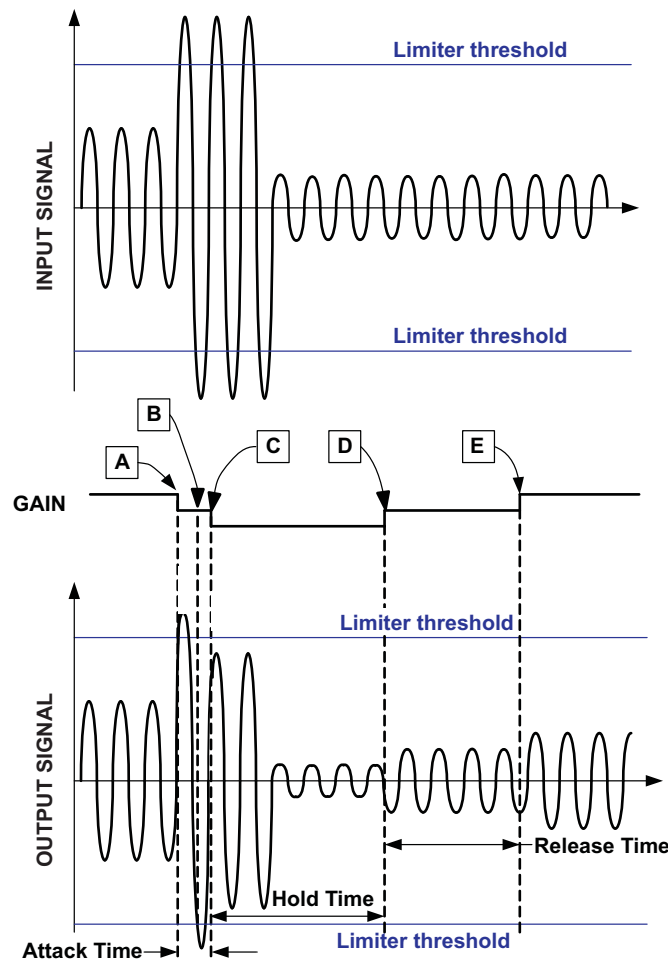

- A. Gain decreases with no delay; attack time is reset. Release time and hold time are reset.
- B. Signal amplitude above limiter level, but gain cannot change because attack time is not over.
- C. Attack time ends; gain is allowed to decrease from this point forward by one step. Gain decreases because the amplitude remains above limiter threshold. All times are reset
- D. Gain increases after release time finishes and signal amplitude remains below desired level. All times are reset after the gain increase.
- E. Gain increases after release time is finished again because signal amplitude remains below desired level. All times are reset after the gain increase.

Figure 32. Input and Output Audio Signal vs Time

Because the number of gain steps is limited the compression region is limited as well. Figure 33 shows how the gain changes versus the input signal amplitude in the compression region.

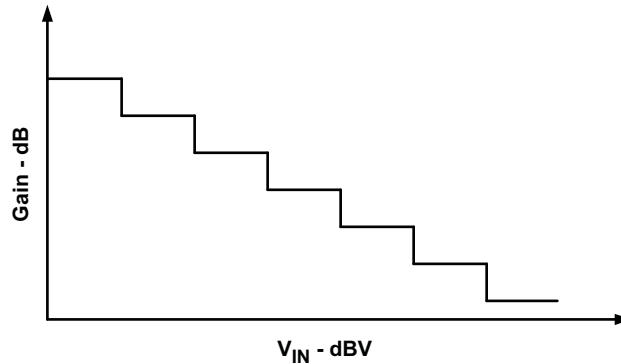

Figure 33. Input Signal Voltage vs Gain

Thus the AGC performs a mapping of the input signal versus the output signal amplitude. This mapping can be modified according to the variables from Table 2.

The following graphs and explanations show the effect of each variable to the AGC independently and which considerations should be taken when choosing values.

9.3.1.1 Fixed Gain

The fixed gain determines the initial gain of the AGC. Set the gain using the following variables:

- Set the fixed gain to be equal to the gain when the AGC is disabled.
- Set the fixed gain to maximize SNR.
- Set the fixed gain such that it will not overdrive the speaker.

Figure 34 shows how the fixed gain influences the input signal amplitude versus the output signal amplitude state diagram. The dotted 1:1 line is displayed for reference. The 1:1 line means that for a 1-dB increase in the input signal, the output increases by 1 dB.

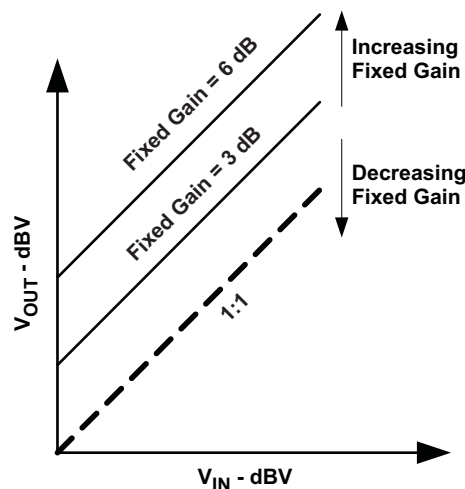

Figure 34. Output Signal vs Input Signal State Diagram Showing Different Fixed Gain Configurations

If the Compression function is enabled, the Fixed Gain is adjustable from –28 dB to 30 dB. If the Compression function is disabled, the Fixed gain is adjustable from 0 dB to 30 dB.

9.3.1.2 Limiter Level

The Limiter level sets the maximum amplitude allowed at the output of the amplifier. The limiter should be set with the following constraints in mind:

- Below or at the maximum power rating of the speaker
- Below the minimum supply voltage in order to avoid clipping

Figure 35 shows how the limiter level influences the input signal amplitude versus the output signal amplitude state diagram.

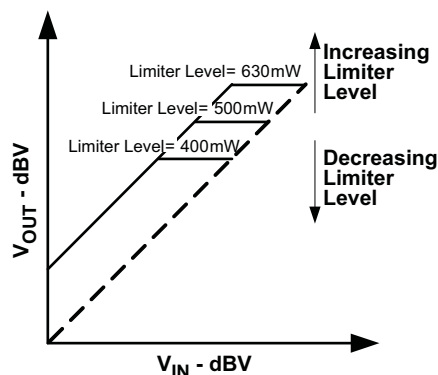

Figure 35. Output Signal vs Input Signal State Diagram Showing Different Limiter Level Configurations

The limiter level and the fixed gain influence each other. If the fixed gain is set high, the AGC has a large limiter range. The fixed gain is set low, the AGC has a short limiter range. Figure 36 illustrates the two examples:

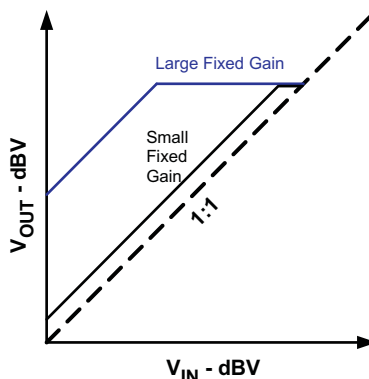

Figure 36. Output Signal vs Input Signal State Diagram Showing Same Limiter Level Configurations With Different Fixed Gain Configurations

9.3.1.3 Compression Ratio

The compression ratio sets the relation between input and output signal outside the limiter level region. The compression ratio compresses the dynamic range of the audio. For example if the audio source has a dynamic range of 60 dB and compression ratio of 2:1 is selected, then the output has a dynamic range of 30 dB. Most small form factor speakers have small dynamic range. Compression ratio allows audio with large dynamic range to fit into a speaker with small dynamic range.

The compression ratio also increases the loudness of the audio without increasing the peak voltage. The higher the compression ratio, the louder the perceived audio.

For example:

- A compression ratio of 4:1 is selected (meaning that a 4-dB change in the input signal results in a 1-dB signal change at the output)
- A fixed gain of 0 dB is selected and the maximum audio level is at 0 dBV.

When the input signal decreases to -32 dBV, the amplifier increases the gain to 24 dB in order to achieve an output of -8 dBV. The output signal amplitude equation is:

$$\text{Output signal amplitude} = \frac{\text{Input signal initial amplitude} - |\text{Current input signal amplitude}|}{\text{Compression ratio}} \tag{1}$$

In this example:

$$-8\text{dBV} = \frac{0\text{dBV} - |-32\text{dBV}|}{4} \tag{2}$$

The gain change equation is:

$$\text{Gain change} = \left(1 - \frac{1}{\text{Compression ratio}} \right) \times \text{Input signal change} \tag{3}$$

$$24\text{ dB} = \left(1 - \frac{1}{4} \right) \times 32 \tag{4}$$

Consider the following when setting the compression ratio:

- Dynamic range of the speaker
- Fixed gain level
- Limiter Level
- Audio Loudness vs Output Dynamic Range

Figure 37 shows different settings for dynamic range and different fixed gain selected but no limiter level.

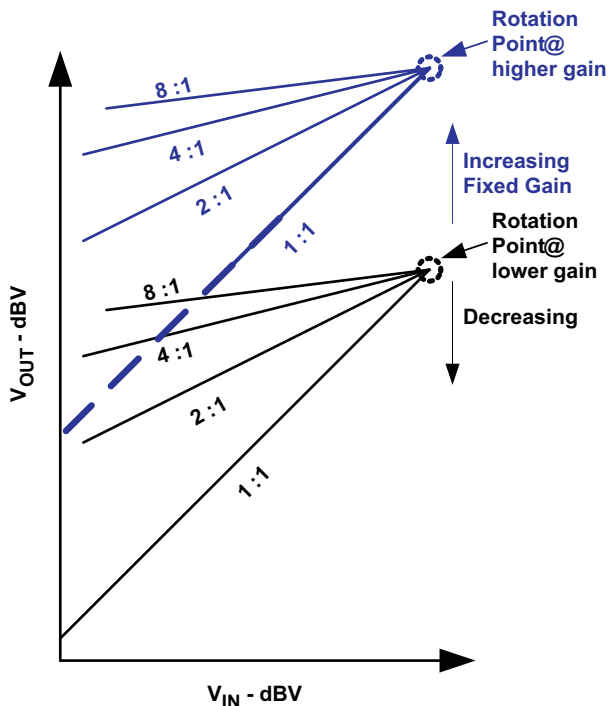

Figure 37. Output Signal vs Input Signal State Diagram Showing Different Compression Ratio Configurations With Different Fixed Gain Configurations

The rotation point is always at $V_{IN} = 10$ dBV. The rotation point is not located at the intersection of the limiter region and the compression region. By changing the fixed gain the rotation point will move in the y-axis direction only, as shown in the previous graph.

9.3.1.4 Interaction Between Compression Ratio and Limiter Range

The compression ratio can be limited by the limiter range.

NOTE

The limiter range is selected by the limiter level and the fixed gain.

For a setting with large limiter range, the amount of gain steps in the AGC remaining to perform compression are limited. Figure 38 shows two examples, where the fixed gain was changed.

1. Small limiter range yielding a large compression region (small fixed gain).
2. Large limiter range yielding a small compression region (large fixed gain).

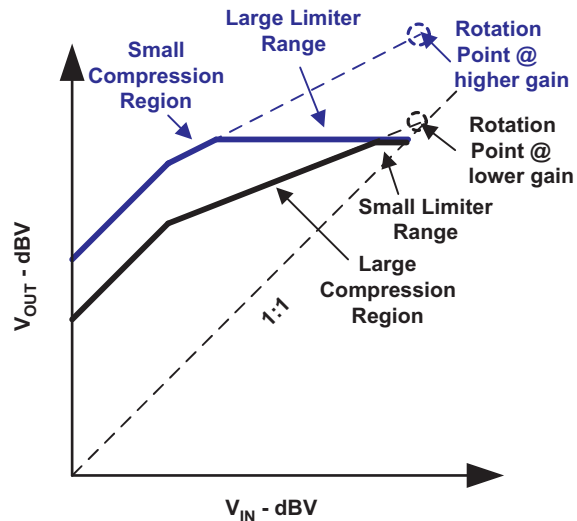

Figure 38. Output Signal vs Input Signal State Diagram Showing the Effects of the Limiter Range to the Compression Region

9.3.1.5 Noise Gate Threshold

The noise gate threshold prevents the AGC from changing the gain when there is no audio at the input of the amplifier. The noise gate threshold stops gain changes until the input signal is above the noise gate threshold. Select the noise gate threshold to be above the noise but below the minimum audio at the input of the amplifier signal. A filter is needed between delta-sigma CODEC/DAC and TPA2026D2 for effectiveness of the noise gate function. The filter eliminates the out-of-band noise from delta-sigma modulation and keeps the CODEC/DAC output noise lower than the noise gate threshold.

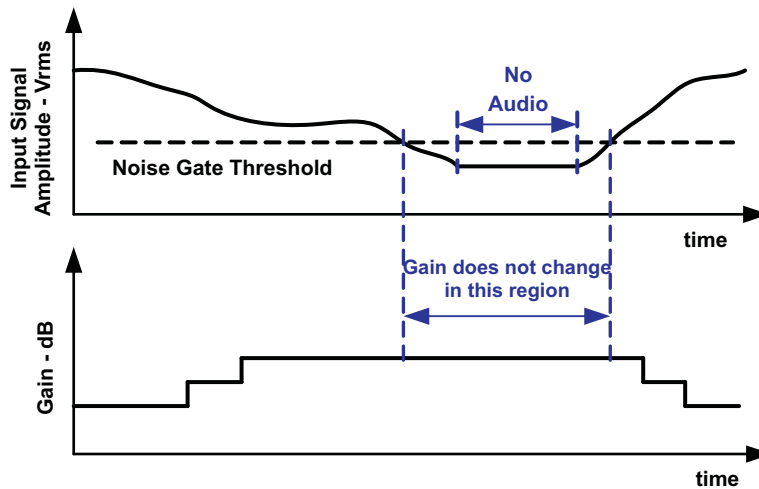

Figure 39. Time Diagram Showing the Relationship Between Input Signal Amplitude, Noise Gate Threshold, and Gain Versus Time

9.3.1.6 Maximum Gain

This variable limits the number of gain steps in the AGC. This feature is useful in order to accomplish a more advanced output signal versus input signal transfer characteristic.

For example, to prevent the gain from going above a certain value, reduce the maximum gain.

However, this variable will affect the limiter range and the compression region. If the maximum gain is decreased, the limiter range and/or compression region is reduced. Figure 40 illustrates the effects.

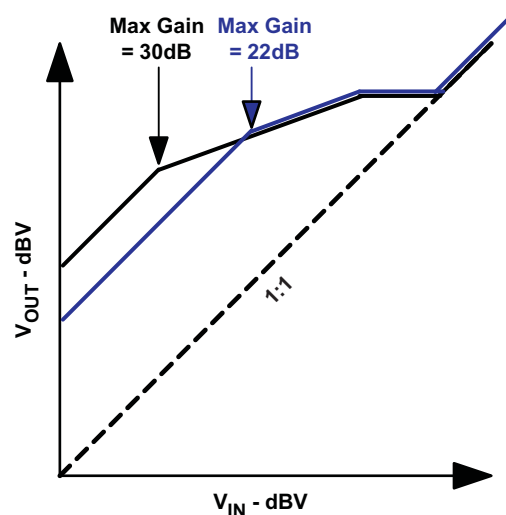

Figure 40. Output Signal vs Input Signal State Diagram Showing Different Maximum Gains

A particular application requiring maximum gain of 22 dB, for example. Thus, set the maximum gain at 22 dB. The amplifier gain never has a gain higher than 22 dB; however, this reduces the limiter range.

9.3.1.7 Attack, Release, and Hold Time

- The attack time is the minimum time between gain decreases.
- The release time is the minimum time between gain increases.
- The hold time is the minimum time between a gain decrease (attack) and a gain increase (release). The hold time can be deactivated. Hold time is only valid if greater than release time.

Successive gain decreases are never faster than the attack time. Successive gain increases are never faster than the release time.

All time variables (attack, release, and hold) start counting after each gain change performed by the AGC. The AGC is allowed to decrease the gain (attack) only after the attack time finishes. The AGC is allowed to increase the gain (release) only after the release time finishes counting. However, if the preceding gain change was an attack (gain increase) and the hold time is enabled and longer than the release time, then the gain is only increased after the hold time.

The hold time is only enabled after a gain decrease (attack). The hold time replaces the release time after a gain decrease (attack). If the gain needs to be increased further, then the release time is used. The release time is used instead of the hold time if the hold time is disabled.

The attack time must be at least 100 times shorter than the release and hold time. The hold time must be the same or greater than the release time. It is important to select reasonable values for those variables in order to prevent the gain from changing too often or too slow.

Figure 41 illustrates the relationship between the three time variables.

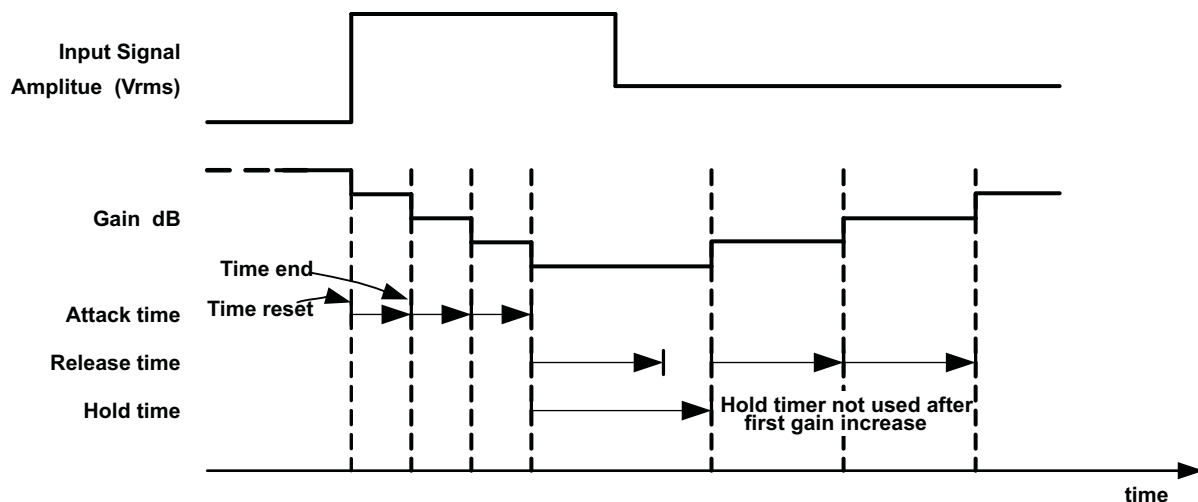

Figure 41. Time Diagram Showing the Relation Between the Attack, Release, and Hold Time vs Input Signal Amplitude and Gain

Figure 42 shows a state diagram of the input signal amplitude versus the output signal amplitude and a summary of how the variables from Table 2 described in the preceding pages affect them.

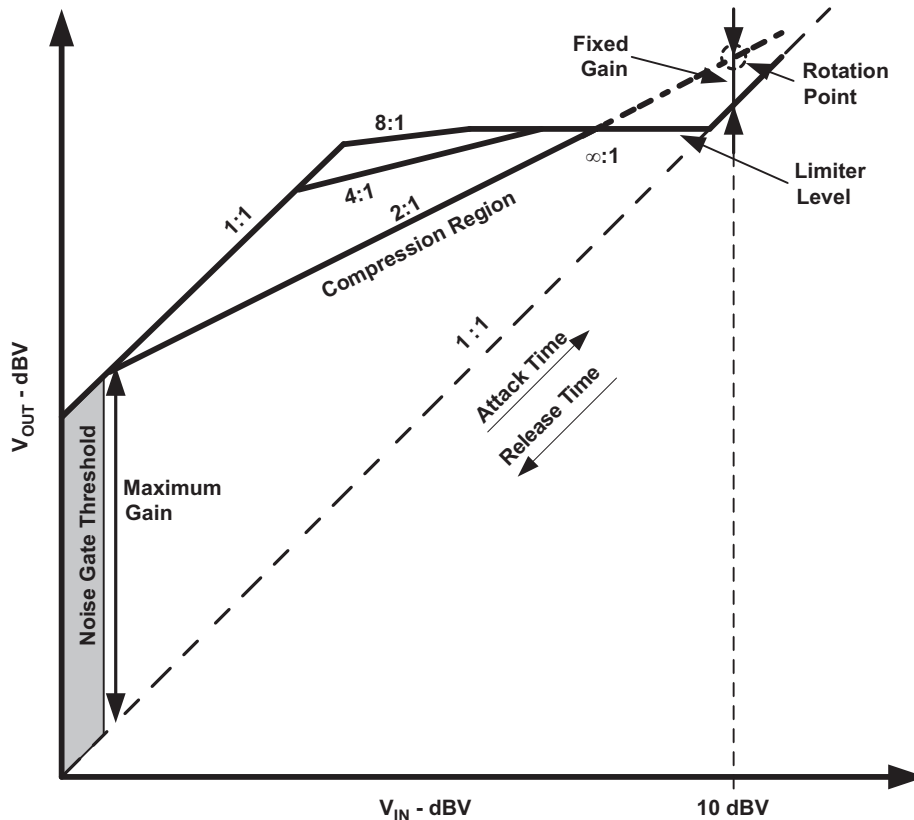

Figure 42. Output Signal vs Input Signal State Diagram

9.3.2 Operation With DACS and CODECS

In using Class-D amplifiers with CODECS and DACs, sometimes there is an increase in the output noise floor from the audio amplifier. This occurs when output frequencies of the CODEC/DAC mix with the Class-D switching frequency and create sum or difference components in the audio band. The noise increase can be solved by placing an RC low-pass filter between the CODEC/DAC and audio amplifier. The filter reduces high frequencies that cause the problem and allows proper performance.

If driving the TPA2016D2 input with 4th-order or higher $\Delta\Sigma$ DACs or CODECS, add an RC low-pass filter at each of the audio inputs (IN+ and IN-) of the TPA2016D2 to ensure best performance. The recommended resistor value is 100 Ω and the capacitor value of 47 nF.

9.3.3 Short-Circuit Auto-Recovery

When a short-circuit event happens, the TPA2026D2 goes to low duty cycle mode and tries to reactivate itself every 110 μ s. This auto-recovery continues until the short-circuit event stops. This feature can protect the device without affecting the device's long-term reliability. FAULT bit (register 1, bit 3) still requires a write to clear.

9.3.4 Filter-Free Operation and Ferrite Bead Filters

A ferrite bead filter can often be used if the design is failing radiated emissions without an LC filter and the frequency-sensitive circuit is greater than 1 MHz. This filter functions well for circuits that just have to pass FCC and CE because FCC and CE only test radiated emissions greater than 30 MHz. When choosing a ferrite bead, choose one with high impedance at high frequencies, and low impedance at low frequencies. In addition, select a ferrite bead with adequate current rating to prevent distortion of the output signal.

Use an LC output filter if there are low frequency (< 1 MHz) EMI-sensitive circuits or there are long leads from amplifier to speaker. Figure 43 shows typical ferrite bead and LC output filters.

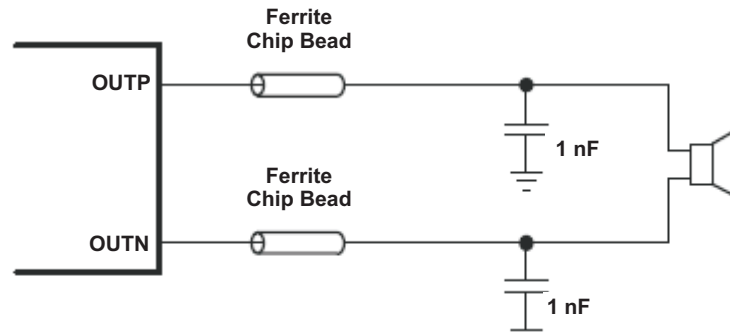

Figure 43. Typical Ferrite Bead Filter (Chip Bead Example: TDK: MPZ1608S221A)

9.4 Device Functional Modes

9.4.1 TPA2026D2 AGC Operation

The TPA2026D2 is controlled by the I²C interface. The correct start-up sequence is:

1. Apply the supply voltage to the AV_{DD} and PV_{DD} (L, R) pins.
2. Apply a voltage above V_{IH} to the SDZ pin. The TPA2026D2 powers up the I²C interface and the control logic. By default, the device is in active mode (SWS = 0). After 5 ms the amplifier enables the class-D output stage and become fully operational.

9.4.1.1 AGC Start-Up Condition

The amplifier gain at start-up depends on the following conditions:

1. Start-up from hardware reset (EN from 0 to 1): The amplifier starts up immediately at default fixed gain. AGC starts controlling gain once the input audio signal exceeds noise gate threshold.
2. Start-up from software shutdown (SWS from 1 to 0): The amplifier starts up immediately at the latest fixed gain during software shutdown, regardless the attack or release time. For example:
 - Audio is playing at fixed gain 6 dB
 - Devices goes to software shutdown (SWS = 1)
 - Set fixed gain from 6 dB to 12 dB
 - Remove software shutdown (SWS = 0)
 - Amplifier starts up immediately at 12 dB
3. During audio playback with AGC on, gain changes according to attack or release time. For example:
 - Audio is playing at fixed gain 6 dB and 1:1 compression ratio
 - Set fixed gain from 6 dB to 12 dB, at release time 500 ms / 6 dB
 - Amplifier takes 500 ms to ramp from 6 dB to 12 dB
4. When SPKR_EN_R = 0, SPKR_EN_L = 0 and SWS = 0, the amplifier is set at fixed gain. The amplifier will start up at fixed gain when either SPKR_EN_R and SPKR_EN_L transitions from 0 to 1.

CAUTION

Do not interrupt the start-up sequence after changing SDZ from V_{IL} to V_{IH}.
Do not interrupt the start-up sequence after changing SWS from 1 to 0.

The default conditions of TPA2026D2 allows audio playback without I²C control. Refer to [Table 5](#) for the entire default conditions.

There are several options to disable the amplifier:

- Write SPK_EN_R = 0 and SPK_EN_L = 0 to the register (0x01, 6 and 0x01, 7). This write disables each speaker amplifier, but leaves all other circuits operating.

Device Functional Modes (continued)

- Write SWS = 1 to the register (0x01, 5). This action disables most of the amplifier functions.
- Apply V_{IL} to SDZ. This action shuts down all the circuits and has very low quiescent current consumption. This action resets the registers to its default values.

CAUTION

Do not interrupt the shutdown sequence after changing SDZ from V_{IH} to V_{IL} .
Do not interrupt the shutdown sequence after changing SWS from 0 to 1.

9.4.2 TPA2026D2 AGC Recommended Settings

Table 3. Recommended AGC Settings for Different Types of Audio Source ($V_{DD} = 3.6\text{ V}$)

AUDIO SOURCE	COMPRESSION RATIO	ATTACK TIME (ms/6 dB)	RELEASE TIME (ms/6 dB)	HOLD TIME (ms)	FIXED GAIN (dB)	LIMITER LEVEL (dBV)
Pop Music	4:1	1.28 to 3.84	986 to 1640	137	6	7.5
Classical	2:1	2.56	1150	137	6	8
Jazz	2:1	5.12 to 10.2	3288	—	6	8
Rap/Hip Hop	4:1	1.28 to 3.84	1640	—	6	7.5
Rock	2:1	3.84	4110	—	6	8
Voice/News	4:1	2.56	1640	—	6	8.5

9.5 Programming

9.5.1 General I²C Operation

The I²C bus employs two signals, SDA (data) and SCL (clock), to communicate between integrated circuits in a system. The bus transfers data serially one bit at a time. The address and data 8-bit bytes are transferred most significant bit (MSB) first. In addition, each byte transferred on the bus is acknowledged by the receiving device with an *acknowledge* bit. Each transfer operation begins with the master device driving a start condition on the bus and ends with the master device driving a stop condition on the bus. The bus uses transitions on the data terminal (SDA) while the clock is at logic high to indicate start and stop conditions. A high-to-low transition on SDA indicates a start and a low-to-high transition indicates a stop. Normal data-bit transitions must occur within the low time of the clock period. Figure 44 shows a typical sequence. The master generates the 7-bit slave address and the read/write (R/W) bit to open communication with another device, and then waits for an acknowledge condition. The TPA2026D2 holds SDA low during the acknowledge clock period to indicate acknowledgment. When this acknowledgment occurs, the master transmits the next byte of the sequence. Each device is addressed by a unique 7-bit slave address plus R/W bit (1 byte). All compatible devices share the same signals through a bidirectional bus using a wired-AND connection.

An external pullup resistor must be used for the SDA and SCL signals to set the logic high level for the bus. When the bus level is 5 V, use pullup resistors between 1 k Ω and 2 k Ω .

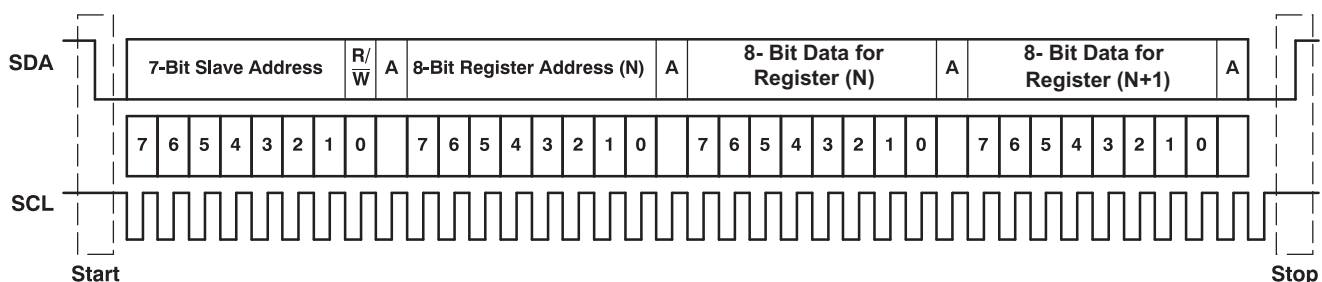

Figure 44. Typical I²C Sequence

Programming (continued)

There is no limit on the number of bytes that can be transmitted between start and stop conditions. When the last word transfers, the master generates a stop condition to release the bus. A generic data transfer sequence is shown in [Figure 44](#).

9.5.2 Single and Multiple-Byte Transfers

The serial control interface supports both single-byte and multi-byte read/write operations for all registers.

During multiple-byte read operations, the TPA2026D2 responds with data, one byte at a time, starting at the register assigned, as long as the master device continues to respond with acknowledgments.

The TPA2026D2 supports sequential I²C addressing. For write transactions, if a register is issued followed by data for that register and all the remaining registers that follow, a sequential I²C write transaction has occurred. For I²C sequential write transactions, the register issued then serves as the starting point, and the amount of data subsequently transmitted, before a stop or start is transmitted, determines the number of registers written.

9.5.3 Single-Byte Write

As [Figure 45](#) shows, a single-byte data write transfer begins with the master device transmitting a start condition followed by the I²C device address and the read/write bit. The read/write bit determines the direction of the data transfer. For a write data transfer, the read/write bit must be set to 0. After receiving the correct I²C device address and the read/write bit, the TPA2026D2 responds with an acknowledge bit. Next, the master transmits the register byte corresponding to the TPA2026D2 internal memory address being accessed. After receiving the register byte, the TPA2026D2 again responds with an acknowledge bit. Next, the master device transmits the data byte to be written to the memory address being accessed. After receiving the register byte, the TPA2026D2 again responds with an acknowledge bit. Finally, the master device transmits a stop condition to complete the single-byte data write transfer.

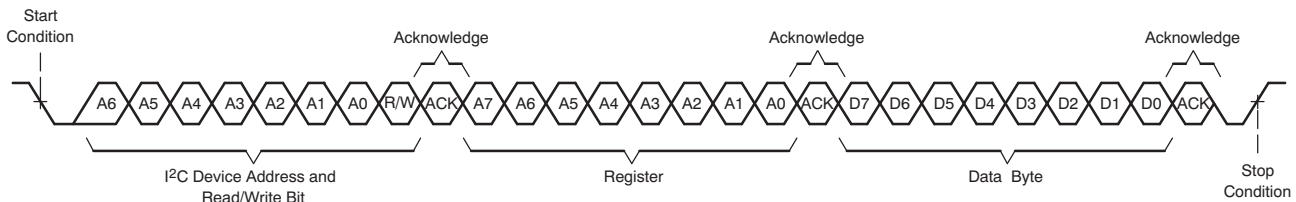

Figure 45. Single-Byte Write Transfer

9.5.4 Multiple-Byte Write and Incremental Multiple-Byte Write

A multiple-byte data write transfer is identical to a single-byte data write transfer except that multiple data bytes are transmitted by the master device to the TPA2026D2 as shown in [Figure 46](#). After receiving each data byte, the TPA2026D2 responds with an acknowledge bit.

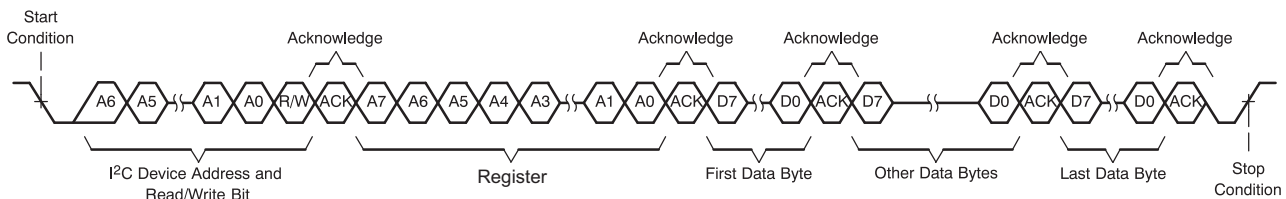

Figure 46. Multiple-Byte Write Transfer

9.5.5 Single-Byte Read

As [Figure 47](#) shows, a single-byte data read transfer begins with the master device transmitting a start condition followed by the I²C device address and the read/write bit. For the data read transfer, both a write followed by a read are actually executed. Initially, a write is executed to transfer the address byte of the internal memory address to be read. As a result, the read/write bit is set to a 0.

Programming (continued)

After receiving the TPA2026D2 address and the read/write bit, the TPA2026D2 responds with an acknowledge bit. The master then sends the internal memory address byte, after which the TPA2026D2 issues an acknowledge bit. The master device transmits another start condition followed by the TPA2026D2 address and the read/write bit again. This time the read/write bit is set to 1, indicating a read transfer. Next, the TPA2026D2 transmits the data byte from the memory address being read. After receiving the data byte, the master device transmits a *not-acknowledge* followed by a stop condition to complete the single-byte data read transfer.

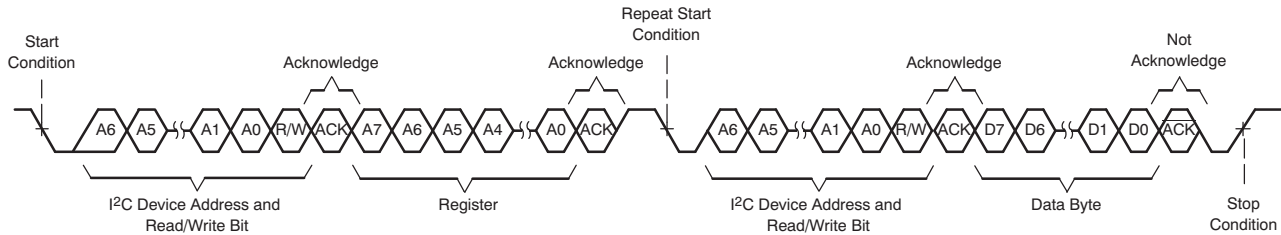

Figure 47. Single-Byte Read Transfer

9.5.6 Multiple-Byte Read

A multiple-byte data read transfer is identical to a single-byte data read transfer except that multiple data bytes are transmitted by the TPA2026D2 to the master device as shown in Figure 48. With the exception of the last data byte, the master device responds with an acknowledge bit after receiving each data byte.

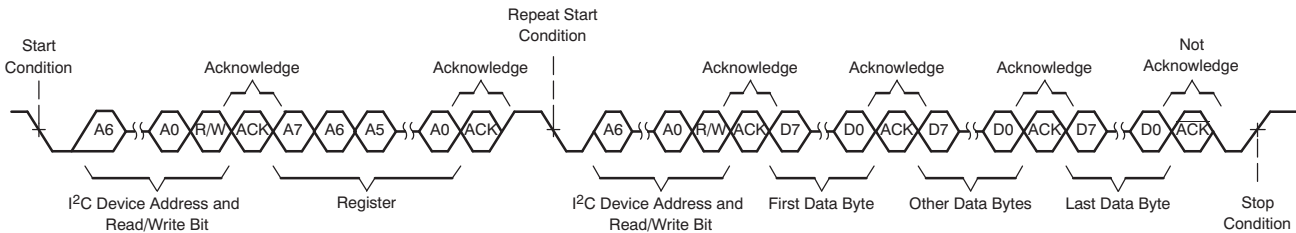

Figure 48. Multiple-Byte Read Transfer

9.6 Register Maps

Table 4. TPA2026D2 Register Map

REGISTER	BIT7	BIT6	BIT5	BIT4	BIT3	BIT2	BIT1	BIT0
1	SPK_EN_R	SPL_EN_L	SWS	FAULT_R	FAULT_L	Thermal	1	NG_EN
2	0	0	ATK_time [5]	ATK_time [4]	ATK_time [3]	ATK_time [2]	ATK_time [1]	ATK_time [0]
3	0	0	REL_time [5]	REL_time [4]	REL_time [3]	REL_time [2]	REL_time [1]	REL_time [0]
4	0	0	Hold_time [5]	Hold_time [4]	Hold_tme [3]	Hold_time [2]	Hold_time [1]	Hold_time [0]
5	0	0	FixedGain [5]	FixedGain [4]	FixedGain [3]	FixedGain [2]	FixedGain [1]	FixedGain [0]
6	Output Limiter Disable	NoiseGate Threshold [1]	NoiseGate Threshold [2]	Output Limiter Level [4]	Output Limiter Level [3]	Output Limiter Level [2]	Output Limiter Level [1]	Output Limiter Level [0]
7	Max Gain [3]	Max Gain [2]	Max Gain [1]	Max Gain [0]	0	0	Compression Ratio [1]	Compression Ratio [0]

The default register map values are given in [Table 5](#).

Table 5. TPA2026D2 Default Register Values

REGISTER	0x01	0x02	0x03	0x04	0x05	0x06	0x07
Default	C3h	05h	0Bh	00h	06h	3Ah	C2h

Any register above address 0x08 is reserved for testing and must not be written to because it may change the function of the device. If read, these bits may assume any value.

Some of the default values can be reprogrammed through the I²C interface and written to the EEPROM. This function is useful to speed up the turnon time of the device and minimizes the number of I²C writes. If this is required, contact your local TI representative.

The TPA2026D2 I²C address is 0xB0 (binary 10110000) for writing and 0xB1 (binary 10110001) for reading. If a different I²C address is required, contact your local TI representative. See [General I²C Operation](#) for more details.

The following tables show the details of the registers, the default values, and the values that can be programmed through the I²C interface.

9.6.1 IC Function Control (Address: 1)

Table 6. IC Function Control (Address: 1)

REGISTER ADDRESS	I ² C BIT	LABEL	DEFAULT	DESCRIPTION
01 (01 _H) – IC Function Control	7	SPK_EN_R	1 (enabled)	Enables right amplifier
	6	SPK_EN_L	1 (enabled)	Enables left amplifier
	5	SWS	0 (enabled)	Shutdown IC when bit = 1
	4	FAULT_R	0	Changes to a 1 when there is a short on the right channel. Reset by writing a 0.
	3	FAULT_L	0	Changes to a 1 when there is a short on the left channel. Reset by writing a 0
	2	Thermal	0	Changes to a 1 when die temperature is above 150°C
	1	UNUSED	1	
	0	NG_EN	1 (enabled)	Enables Noise Gate function

SPK_EN_R: Enable bit for the right-channel amplifier. Amplifier is active when bit is high. This function is gated by thermal and returns once the IC is below the threshold temperature.

SPK_EN_L: Enable bit for the left-channel amplifier. Amplifier is active when bit is high. This function is gated by thermal and returns once the IC is below the threshold temperature

SWS: Software shutdown control. The device is in software shutdown when the bit is 1 (control, bias and oscillator are inactive). When the bit is 0 the control, bias and oscillator are enabled.

FAULT_L: This bit indicates that an over-current event has occurred on the left channel with a 1. This bit is cleared by writing a 0 to it.

FAULT_R: This bit indicates that an over-current event has occurred on the right channel with a 1. This bit is cleared by writing a 0 to it.

Thermal: This bit indicates a thermal shutdown that was initiated by the hardware with a 1. This bit is deglitched and latched, and can be cleared by writing a 0 to it.

NG_EN: Enable bit for the Noise Gate function. This function is enabled when this bit is high. This function can only be enabled when the Compression ratio is not 1:1.

9.6.2 AGC Attack Control (Address: 2)

Table 7. AGC Attack Control (Address: 2)

REGISTER ADDRESS	I ² C BIT	LABEL	DEFAULT	DESCRIPTION			
02 (02 _H) – AGC Control	7:6	Unused	00				
	5:0	ATK_time	000101 (1.28 ms/6 dB)	AGC Attack time (gain ramp down)			
				Per Step	Per 6 dB	90% Range	
				000001	0.1067 ms	1.28 ms	5.76 ms
				000010	0.2134 ms	2.56 ms	11.52 ms
				000011	0.3201 ms	3.84 ms	17.19 ms
				000100	0.4268 ms	5.12 ms	23.04 ms
				(time increases by 0.1067 ms with every step)			
111111	6.722 ms	80.66 ms	362.99 ms				

ATK_time These bits set the attack time for the AGC function. The attack time is the minimum time between gain decreases.

9.6.3 AGC Release Control (Address: 3)

Table 8. AGC Release Control (Address: 3)

REGISTER ADDRESS	I ² C BIT	LABEL	DEFAULT	DESCRIPTION			
03 (03 _H) – AGC Release Control	7:6	Unused	00				
	5:0	REL_time	001011 (0.9864 sec/6 dB)	AGC Release time (gain ramp down)			
				Per Step	Per 6 dB	90% Range	
				000001	0.0137 s	0.1644 s	0.7398 s
				000010	0.0274 s	0.3288 s	1.4796 s
				000011	0.0411 s	0.4932 s	2.2194 s
				000100	0.0548 s	0.6576 s	2.9592 s
				(time increases by 0.0137 s with every step)			
111111	0.8631 s	10.36 s	46.6 s				

REL_time These bits set the release time for the AGC function. The release time is the minimum time between gain increases.

9.6.4 AGC Hold Time Control (Address: 4)

Table 9. AGC Hold Time Control(Address: 4)

REGISTER ADDRESS	I ² C BIT	LABEL	DEFAULT	DESCRIPTION	
04 (04 _H) – AGC Hold Time Control	7:6	Unused	00		
	5:0	Hold_time	000000 (disabled)	AGC Hold time	
				Per Step	
				000000	Hold Time Disable
				000001	0.0137 s
				000010	0.0274 s
				000011	0.0411 s
				000100	0.0548 s
(time increases by 0.0137 s with every step)					
111111	0.8631 s				

Hold_time These bits set the hold time for the AGC function. The hold time is the minimum time between a gain decrease (attack) and a gain increase (release). The hold time can be deactivated.

9.6.5 AGC Fixed Gain Control (Address: 5)

Table 10. AGC Fixed Gain Control (Address: 5)

REGISTER ADDRESS	I ² C BIT	LABEL	DEFAULT	DESCRIPTION			
05 (05 _H) – AGC Fixed Gain Control	7:6	Unused	00				
	5:0	Fixed Gain	000110 (6 dB)	Sets the fixed gain of the amplifier: two's complement			
					Gain		
				100100	–28 dB		
				100101	–27 dB		
				100110	–26 dB		
				(gain increases by 1 dB with every step)			
				111101	–3 dB		
				111110	–2 dB		
				111111	–1 dB		
				000000	0 dB		
				000001	1 dB		
				000010	2 dB		
				000011	3 dB		
				(gain increases by 1 dB with every step)			
	011100	28 dB					
	011101	29 dB					
	011110	30 dB					

Fixed Gain These bits are used to select the fixed gain of the amplifier. If compression is enabled, fixed gain is adjustable from –28 dB to 30 dB. If compression is disabled, fixed gain is adjustable from 0 dB to 30 dB.

9.6.6 AGC Control (Address: 6)

Table 11. AGC Control (Address: 6)

REGISTER ADDRESS	I ² C BIT	LABEL	DEFAULT	DESCRIPTION			
06 (06 _H) – AGC Control	7	Output Limiter Disable	0 (enable)	Disables the output limiter function. Can only be disabled when the AGC compression ratio is 1:1 (off)			
	6:5	NoiseGate Threshold	01 (4 mV _{rms})	Select the threshold of the noise gate			
					Threshold		
				00	1 mV _{rms}		
				01	4 mV _{rms}		
				10	10 mV _{rms}		
		11	20 mV _{rms}				
	4:0	Output Limiter Level	11010 (6.5 dBV)	Selects the output limiter level			
					Output Power (Wrms)	Peak Output Voltage (Vp)	dBV
				00000	0.03	0.67	–6.5
				00001	0.03	0.71	–6
				00010	0.04	0.75	–5.5
				(Limiter level increases by 0.5dB with every step)			
				11101	0.79	3.55	8
				11110	0.88	3.76	8.5
	11111	0.99	3.99	9			

Output Limiter Disable This bit disables the output limiter function when set to 1. Can only be disabled when the AGC compression ratio is 1:1

NoiseGate Threshold These bits set the threshold level of the noise gate. NoiseGate Threshold is only functional when the compression ratio is not 1:1

Output Limiter Level These bits select the output limiter level. Output Power numbers are for 8-Ω load.

9.6.7 AGC Control (Address: 7)

Table 12. AGC Control (Address: 7)

REGISTER ADDRESS	I ² C BIT	LABEL	DEFAULT	DESCRIPTION	
07 (07H) – AGC Control	7:4	Max Gain	1100 (30 dB)	Selects the maximum gain the AGC can achieve	
					Gain
				0000	18 dB
				0001	19 dB
				0010	20 dB
		(gain increases by 1 dB with every step)			
		1100	30 dB		
	3:2	Unused	00		
	1:0	Compression Ratio	10 (4:1)	Selects the compression ratio of the AGC	
					Ratio
00				1:1 (off)	
01				2:1	
10				4:1	
	11	8:1			

Compression Ratio These bits select the compression ratio. Output Limiter is enabled by default when the compression ratio is not 1:1.

Max Gain These bits select the maximum gain of the amplifier. In order to maximize the use of the AGC, set the Max Gain to 30 dB

10 Application and Implementation

NOTE

Information in the following applications sections is not part of the TI component specification, and TI does not warrant its accuracy or completeness. TI's customers are responsible for determining suitability of components for their purposes. Customers should validate and test their design implementation to confirm system functionality.

10.1 Application Information

These typical connection diagrams highlight the required external components and system level connections for proper operation of the device. Each of these configurations can be realized using the Evaluation Modules (EVMs) for the device. These flexible modules allow full evaluation of the device in the most common modes of operation. Any design variation can be supported by TI through schematic and layout reviews. Visit e2e.ti.com for design assistance and join the audio amplifier discussion forum for additional information.

10.2 Typical Applications

10.2.1 TPA2026D2 With Differential Input Signals

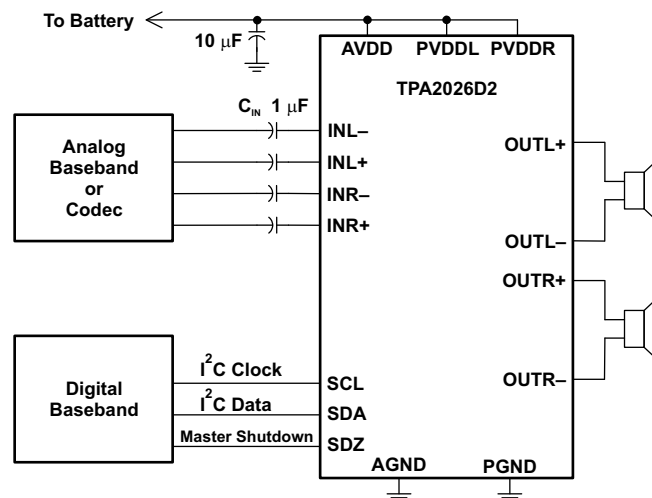

Copyright © 2016, Texas Instruments Incorporated

Figure 49. Typical Application Schematic With Differential Input Signals

10.2.1.1 Design Requirements

For this design example, use the parameters listed in [Table 13](#).

Table 13. Design Procedure

PARAMETER	EXAMPLE VALUE
Power supply	5 V
Enable inputs	High > 1.3 V
	Low < 0.6 V
Speaker	8 Ω

10.2.1.2 Detailed Design Procedure

10.2.1.2.1 Surface Mount Capacitor

Temperature and applied DC voltage influence the actual capacitance of high-K materials. [Table 14](#) shows the relationship between the different types of high-K materials and their associated tolerances, temperature coefficients, and temperature ranges. Notice that a capacitor made with X5R material can lose up to 15% of its capacitance within its working temperature range.

In an application, the working capacitance of components made with high-K materials is generally much lower than nominal capacitance. A worst-case result with a typical X5R material might be –10% tolerance, –15% temperature effect, and –45% DC voltage effect at 50% of the rated voltage. This particular case would result in a working capacitance of 42% ($0.9 \times 0.85 \times 0.55$) of the nominal value.

Select high-K ceramic capacitors according to the following rules:

1. Use capacitors made of materials with temperature coefficients of X5R, X7R, or better.
2. Use capacitors with DC voltage ratings of at least twice the application voltage. Use minimum 10-V capacitors for the TPA2026D2.
3. Choose a capacitance value at least twice the nominal value calculated for the application. Multiply the nominal value by a factor of 2 for safety. If a 10- μ F capacitor is required, use 20 μ F.

The preceding rules and recommendations apply to capacitors used in connection with the TPA2026D2. The TPA2026D2 cannot meet its performance specifications if the rules and recommendations are not followed.

Table 14. Typical Tolerance and Temperature Coefficient of Capacitance by Material

MATERIAL	COG/NPO	X7R	X5R
Typical tolerance	$\pm 5\%$	$\pm 10\%$	80/–20%
Temperature	± 30 ppm	$\pm 15\%$	22/–82%
Temperature range	–55 to 125°C	–55 to 125°C	–30 to 85°C

10.2.1.2.2 Decoupling Capacitor, C_s

The TPA2026D2 is a high-performance Class-D audio amplifier that requires adequate power supply decoupling to ensure the efficiency is high and total harmonic distortion (THD) is low. For higher frequency transients, spikes, or digital hash on the line, a good low equivalent-series-resistance (ESR) 1- μ F ceramic capacitor (typically) placed as close as possible to the device PVDD (L, R) lead works best. Placing this decoupling capacitor close to the TPA2026D2 is important for the efficiency of the Class-D amplifier, because any resistance or inductance in the trace between the device and the capacitor can cause a loss in efficiency. For filtering lower-frequency noise signals, a 4.7 μ F or greater capacitor placed near the audio power amplifier would also help, but it is not required in most applications because of the high PSRR of this device.

10.2.1.2.3 Input Capacitors, C_i

The input capacitors and input resistors form a high-pass filter with the corner frequency, f_c , determined in [Equation 5](#).

$$f_c = \frac{1}{(2\pi \times R_i \times C_i)} \quad (5)$$

The value of the input capacitor is important to consider as it directly affects the bass (low frequency) performance of the circuit. Speakers in wireless phones cannot usually respond well to low frequencies, so the corner frequency can be set to block low frequencies in this application. Not using input capacitors can increase output offset. [Equation 6](#) is used to solve for the input coupling capacitance. If the corner frequency is within the audio band, the capacitors must have a tolerance of $\pm 10\%$ or better, because any mismatch in capacitance causes an impedance mismatch at the corner frequency and below.

$$C_i = \frac{1}{(2\pi \times R_i \times f_c)} \quad (6)$$

10.2.1.3 Application Curves

For application curves, see the figures listed in [Table 15](#).

Table 15. Table of Graphs

DESCRIPTION	FIGURE NUMBER
Output Level vs Input Level	Figure 6
THD+N vs Frequency	Figure 11
Total Power Dissipation vs Total Output Power	Figure 22
Output Power vs Supply Voltage	Figure 26

10.2.2 TPA2026D2 With Single-Ended Input Signal

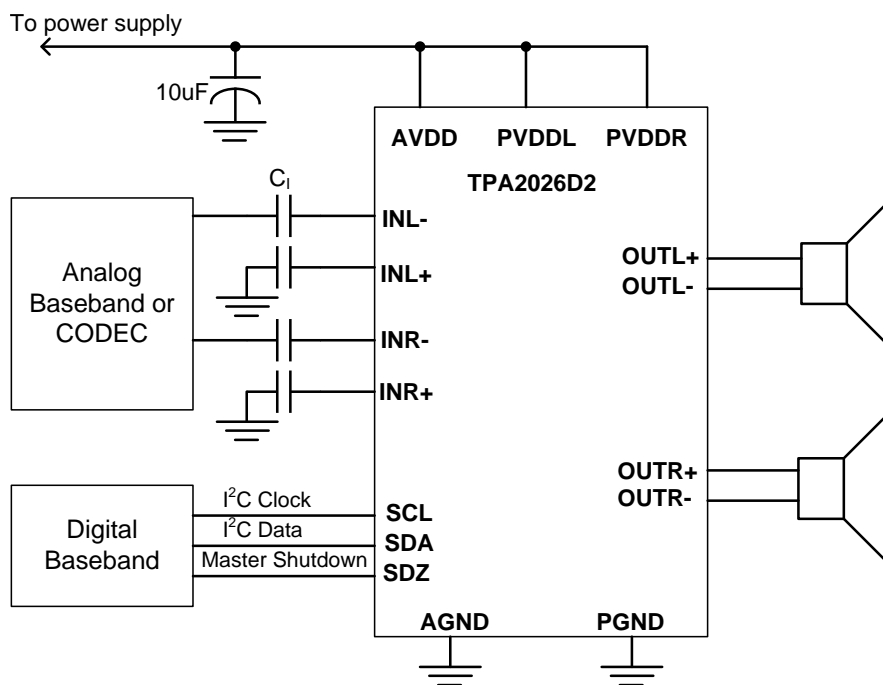

Copyright © 2016, Texas Instruments Incorporated

Figure 50. Typical Application Schematic With Single-Ended Input Signal

10.2.2.1 Design Requirements

For this design example, use the parameters listed in [Table 13](#).

10.2.2.2 Detailed Design Procedure

For the design procedure see [Detailed Design Procedure](#) from the previous section

10.2.2.3 Application Curves

For application curves, see the figures listed in [Table 15](#).

11 Power Supply Recommendations

The TPA2026D2 is designed to operate from an input voltage supply range between 2.5 V and 5.5 V. Therefore the output voltage range of the power supply should be within this range. The current capability of upper power must not exceed the maximum current limit of the power switch.

11.1 Power Supply Decoupling Capacitors

The TPA2026D2 requires adequate power supply decoupling to ensure a high efficiency operation with low total harmonic distortion (THD). Place a low equivalent-series-resistance (ESR) ceramic capacitor, typically 0.1 μF , within 2 mm of the VDD/VCCOUT pin. This choice of capacitor and placement helps with higher frequency transients, spikes, or digital hash on the line. In addition to the 0.1- μF ceramic capacitor, is recommended to place a 2.2- μF to 10- μF capacitor on the VDD supply trace. This larger capacitor acts as a charge reservoir, providing energy faster than the board supply, thus helping to prevent any droop in the supply voltage.

12 Layout

12.1 Layout Guidelines

12.1.1 Pad Size

In making the pad size for the WCSP balls, TI recommends that the layout use non solder mask-defined (NSMD) land. With this method, the solder mask opening is made larger than the desired land area, and the opening size is defined by the copper pad width. [Figure 51](#) and [Table 16](#) show the appropriate diameters for a WCSP layout. The TPA2026D2 evaluation module (EVM) layout is shown in [Layout Example](#).

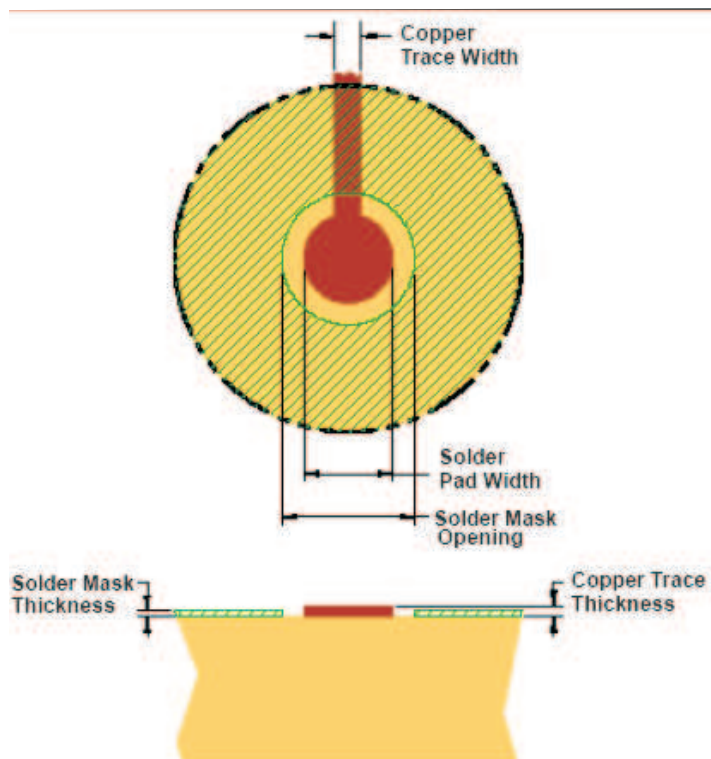

Figure 51. Land Pattern Dimensions

Layout Guidelines (continued)

Table 16. Land Pattern Dimensions^{(1) (2) (3) (4)}

SOLDER PAD DEFINITIONS	COPPER PAD	SOLDER MASK ⁽⁵⁾ OPENING	COPPER THICKNESS	STENCIL ^{(6) (7)} OPENING	STENCIL THICKNESS
Non solder mask defined (NSMD)	275 μm (+0.0, -25 μm)	375 μm (+0.0, -25 μm)	1 oz max (32 μm)	275 μm \times 275 μm Sq. (rounded corners)	125 μm thick

- (1) Circuit traces from NSMD defined PWB lands should be 75 μm to 100 μm wide in the exposed area inside the solder mask opening. Wider trace widths reduce device stand off and impact reliability.
- (2) Best reliability results are achieved when the PWB laminate glass transition temperature is above the operating the range of the intended application.
- (3) Recommend solder paste is Type 3 or Type 4.
- (4) For a PWB using a Ni/Au surface finish, the gold thickness must be less 0.5 μm to avoid a reduction in thermal fatigue performance.
- (5) Solder mask thickness must be less than 20 μm on top of the copper circuit pattern
- (6) Best solder stencil performance is achieved using laser cut stencils with electro polishing. Use of chemically etched stencils results in inferior solder paste volume control.
- (7) Trace routing away from WCSP device must be balanced in X and Y directions to avoid unintentional component movement due to solder wetting forces.

12.1.2 Component Location

Place all external components very close to the TPA2026D2. Placing the decoupling capacitor, C_S , close to the TPA2026D2 is important for the efficiency of the Class-D amplifier. Any resistance or inductance in the trace between the device and the capacitor can cause a loss in efficiency.

12.1.3 Trace Width

Recommended trace width at the solder balls is 75 μm to 100 μm to prevent solder wicking onto wider PCB traces. For high current pins (PVDD (L, R), PGND, and audio output pins) of the TPA2026D2, use 100- μm trace widths at the solder balls and at least 500- μm PCB traces to ensure proper performance and output power for the device. For the remaining signals of the TPA2026D2, use 75- μm to 100- μm trace widths at the solder balls. The audio input pins (INR \pm and INL \pm) must run side-by-side to maximize common-mode noise cancellation.

12.2 Layout Example

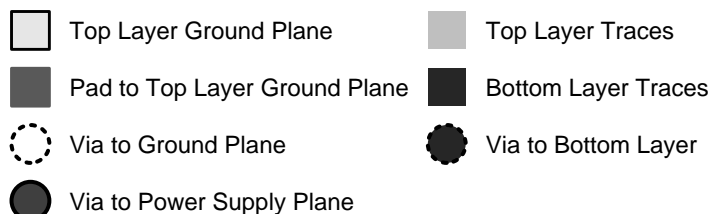
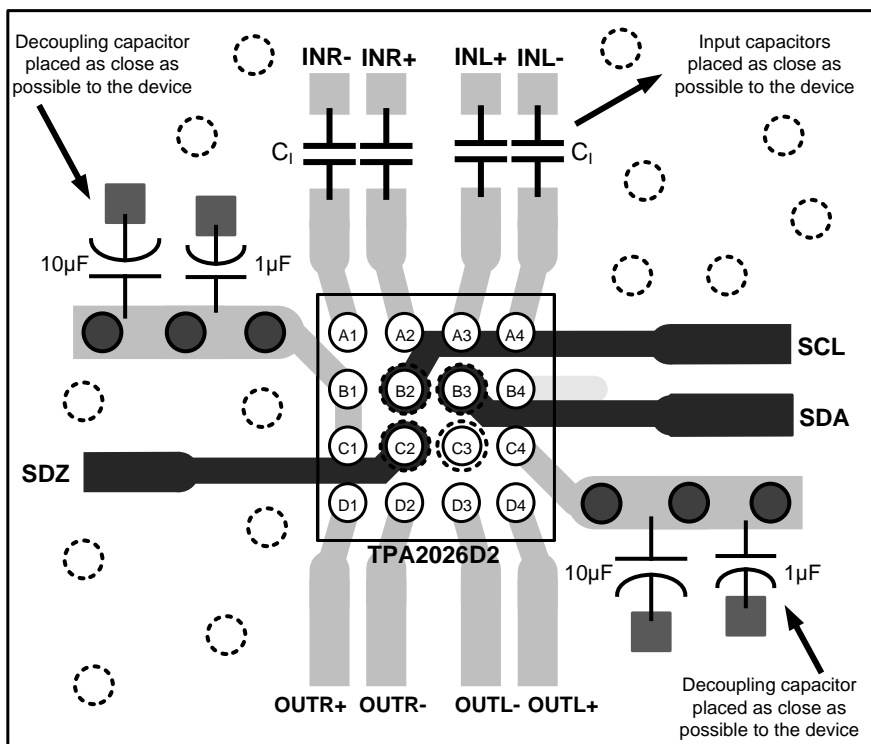

Figure 52. Layout Recommendation

12.3 Efficiency and Thermal Considerations

The maximum ambient temperature depends on the heat-sinking ability of the PCB system. The derating factor for the package is shown in the dissipation rating table. Converting this to θ_{JA} for the DSBGA package:

$$\theta_{JA} = \frac{1}{\text{Derating Factor}} = \frac{1}{0.01} = 100^{\circ}\text{C/W} \quad (7)$$

Given θ_{JA} of 100°C/W , the maximum allowable junction temperature of 150°C , and the maximum internal dissipation of 0.4 W (0.2 W per channel) for 1.5 W per channel, 8- Ω load, 5-V supply, from Figure 15, the maximum ambient temperature can be calculated with the following equation.

$$T_{A\text{Max}} = T_{J\text{Max}} - \theta_{JA} P_{D\text{MAX}} = 150 - 100 (0.4) = 110^{\circ}\text{C} \quad (8)$$

Equation 8 shows that the calculated maximum ambient temperature is 110°C at maximum power dissipation with a 5-V supply and 8- Ω load. The TPA2026D2 is designed with thermal protection that turns the device off when the junction temperature surpasses 150°C to prevent damage to the IC. Also, using speakers more resistive than 8- Ω dramatically increases the thermal performance by reducing the output current and increasing the efficiency of the amplifier.

13 Device and Documentation Support

13.1 Device Support

13.1.1 Third-Party Products Disclaimer

TI'S PUBLICATION OF INFORMATION REGARDING THIRD-PARTY PRODUCTS OR SERVICES DOES NOT CONSTITUTE AN ENDORSEMENT REGARDING THE SUITABILITY OF SUCH PRODUCTS OR SERVICES OR A WARRANTY, REPRESENTATION OR ENDORSEMENT OF SUCH PRODUCTS OR SERVICES, EITHER ALONE OR IN COMBINATION WITH ANY TI PRODUCT OR SERVICE.

13.2 Community Resources

The following links connect to TI community resources. Linked contents are provided "AS IS" by the respective contributors. They do not constitute TI specifications and do not necessarily reflect TI's views; see TI's [Terms of Use](#).

TI E2E™ Online Community *TI's Engineer-to-Engineer (E2E) Community*. Created to foster collaboration among engineers. At e2e.ti.com, you can ask questions, share knowledge, explore ideas and help solve problems with fellow engineers.

Design Support *TI's Design Support* Quickly find helpful E2E forums along with design support tools and contact information for technical support.

13.3 Trademarks

SmartGain, Nano-Free, E2E are trademarks of Texas Instruments. All other trademarks are the property of their respective owners.

13.4 Electrostatic Discharge Caution



These devices have limited built-in ESD protection. The leads should be shorted together or the device placed in conductive foam during storage or handling to prevent electrostatic damage to the MOS gates.

13.5 Glossary

[SLYZ022](#) — *TI Glossary*.

This glossary lists and explains terms, acronyms, and definitions.

14 Mechanical, Packaging, and Orderable Information

The following pages include mechanical, packaging, and orderable information. This information is the most current data available for the designated devices. This data is subject to change without notice and revision of this document. For browser-based versions of this data sheet, refer to the left-hand navigation.

14.1 YZH Package Dimensions

The package dimensions for this YZH package are shown in the table below. See the package drawing at the end of this data sheet for more details.

Packaged Devices	D	E
TPA2026D2YZH	Max = 2160 μm	Max = 2137 μm
	Min = 2100 μm	Min = 2077 μm

PACKAGING INFORMATION

Orderable Device	Status (1)	Package Type	Package Drawing	Pins	Package Qty	Eco Plan (2)	Lead/Ball Finish (6)	MSL Peak Temp (3)	Op Temp (°C)	Device Marking (4/5)	Samples
TPA2026D2YZHR	ACTIVE	DSBGA	YZH	16	3000	Green (RoHS & no Sb/Br)	SNAGCU	Level-1-260C-UNLIM	-40 to 85	NSV	Samples
TPA2026D2YZHT	ACTIVE	DSBGA	YZH	16	250	Green (RoHS & no Sb/Br)	SNAGCU	Level-1-260C-UNLIM	-40 to 85	NSV	Samples

(1) The marketing status values are defined as follows:

ACTIVE: Product device recommended for new designs.

LIFEBUY: TI has announced that the device will be discontinued, and a lifetime-buy period is in effect.

NRND: Not recommended for new designs. Device is in production to support existing customers, but TI does not recommend using this part in a new design.

PREVIEW: Device has been announced but is not in production. Samples may or may not be available.

OBsolete: TI has discontinued the production of the device.

(2) **RoHS:** TI defines "RoHS" to mean semiconductor products that are compliant with the current EU RoHS requirements for all 10 RoHS substances, including the requirement that RoHS substance do not exceed 0.1% by weight in homogeneous materials. Where designed to be soldered at high temperatures, "RoHS" products are suitable for use in specified lead-free processes. TI may reference these types of products as "Pb-Free".

RoHS Exempt: TI defines "RoHS Exempt" to mean products that contain lead but are compliant with EU RoHS pursuant to a specific EU RoHS exemption.

Green: TI defines "Green" to mean the content of Chlorine (Cl) and Bromine (Br) based flame retardants meet JS709B low halogen requirements of <=1000ppm threshold. Antimony trioxide based flame retardants must also meet the <=1000ppm threshold requirement.

(3) MSL, Peak Temp. - The Moisture Sensitivity Level rating according to the JEDEC industry standard classifications, and peak solder temperature.

(4) There may be additional marking, which relates to the logo, the lot trace code information, or the environmental category on the device.

(5) Multiple Device Markings will be inside parentheses. Only one Device Marking contained in parentheses and separated by a "-" will appear on a device. If a line is indented then it is a continuation of the previous line and the two combined represent the entire Device Marking for that device.

(6) Lead/Ball Finish - Orderable Devices may have multiple material finish options. Finish options are separated by a vertical ruled line. Lead/Ball Finish values may wrap to two lines if the finish value exceeds the maximum column width.

Important Information and Disclaimer:The information provided on this page represents TI's knowledge and belief as of the date that it is provided. TI bases its knowledge and belief on information provided by third parties, and makes no representation or warranty as to the accuracy of such information. Efforts are underway to better integrate information from third parties. TI has taken and continues to take reasonable steps to provide representative and accurate information but may not have conducted destructive testing or chemical analysis on incoming materials and chemicals. TI and TI suppliers consider certain information to be proprietary, and thus CAS numbers and other limited information may not be available for release.

In no event shall TI's liability arising out of such information exceed the total purchase price of the TI part(s) at issue in this document sold by TI to Customer on an annual basis.

TAPE AND REEL INFORMATION

QUADRANT ASSIGNMENTS FOR PIN 1 ORIENTATION IN TAPE

*All dimensions are nominal

Device	Package Type	Package Drawing	Pins	SPQ	Reel Diameter (mm)	Reel Width W1 (mm)	A0 (mm)	B0 (mm)	K0 (mm)	P1 (mm)	W (mm)	Pin1 Quadrant
TPA2026D2YZHR	DSBGA	YZH	16	3000	180.0	8.4	2.35	2.35	0.81	4.0	8.0	Q1
TPA2026D2YZHT	DSBGA	YZH	16	250	180.0	8.4	2.35	2.35	0.81	4.0	8.0	Q1

TAPE AND REEL BOX DIMENSIONS

*All dimensions are nominal

Device	Package Type	Package Drawing	Pins	SPQ	Length (mm)	Width (mm)	Height (mm)
TPA2026D2YZHR	DSBGA	YZH	16	3000	182.0	182.0	20.0
TPA2026D2YZHT	DSBGA	YZH	16	250	182.0	182.0	20.0

YZH (S-XBGA-N16)

DIE-SIZE BALL GRID ARRAY

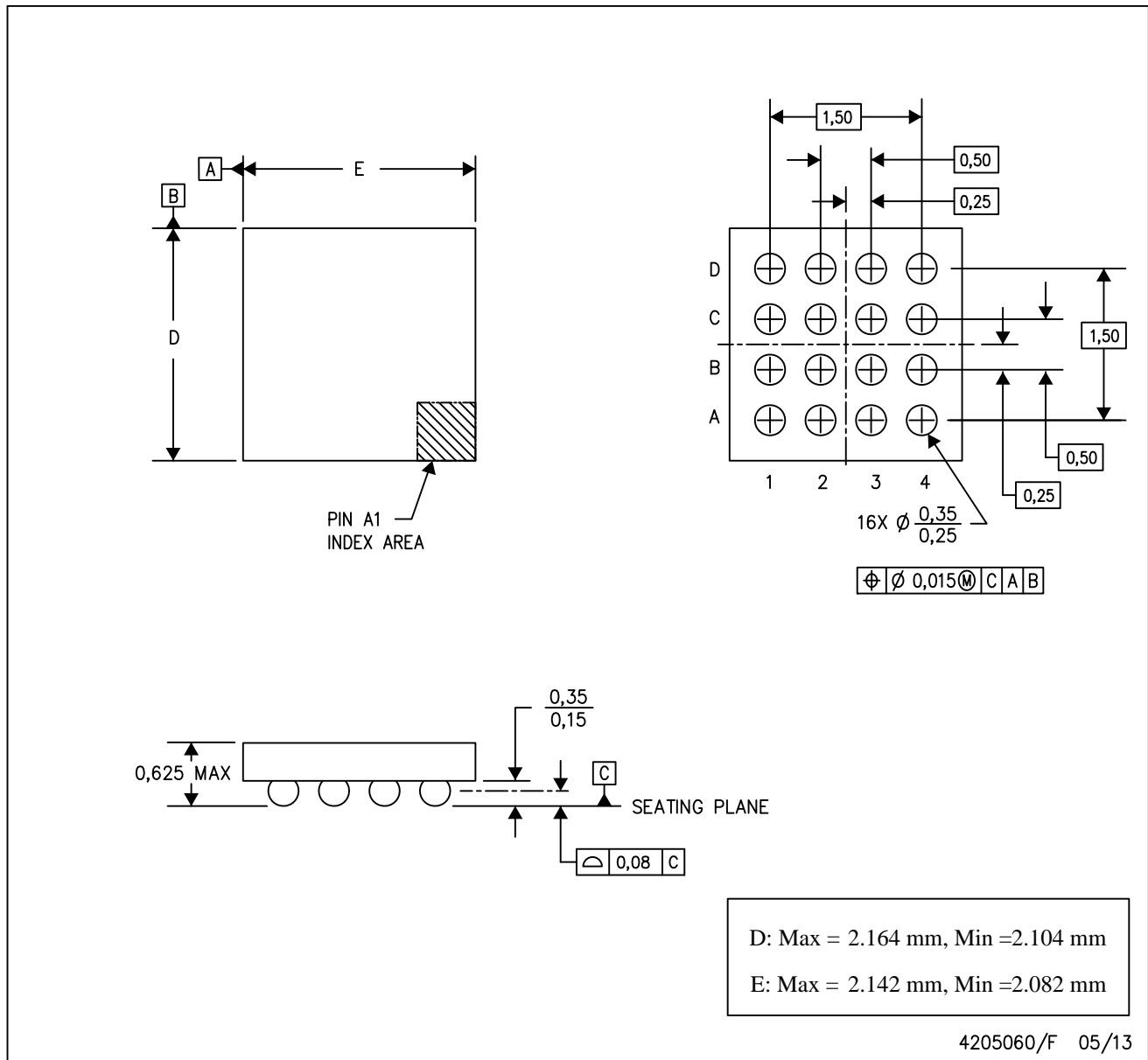

- NOTES:
- A. All linear dimensions are in millimeters.
 - B. This drawing is subject to change without notice.
 - C. NanoFree™ package configuration.

IMPORTANT NOTICE AND DISCLAIMER

TI PROVIDES TECHNICAL AND RELIABILITY DATA (INCLUDING DATASHEETS), DESIGN RESOURCES (INCLUDING REFERENCE DESIGNS), APPLICATION OR OTHER DESIGN ADVICE, WEB TOOLS, SAFETY INFORMATION, AND OTHER RESOURCES "AS IS" AND WITH ALL FAULTS, AND DISCLAIMS ALL WARRANTIES, EXPRESS AND IMPLIED, INCLUDING WITHOUT LIMITATION ANY IMPLIED WARRANTIES OF MERCHANTABILITY, FITNESS FOR A PARTICULAR PURPOSE OR NON-INFRINGEMENT OF THIRD PARTY INTELLECTUAL PROPERTY RIGHTS.

These resources are intended for skilled developers designing with TI products. You are solely responsible for (1) selecting the appropriate TI products for your application, (2) designing, validating and testing your application, and (3) ensuring your application meets applicable standards, and any other safety, security, or other requirements. These resources are subject to change without notice. TI grants you permission to use these resources only for development of an application that uses the TI products described in the resource. Other reproduction and display of these resources is prohibited. No license is granted to any other TI intellectual property right or to any third party intellectual property right. TI disclaims responsibility for, and you will fully indemnify TI and its representatives against, any claims, damages, costs, losses, and liabilities arising out of your use of these resources.

TI's products are provided subject to TI's Terms of Sale (www.ti.com/legal/termsofsale.html) or other applicable terms available either on ti.com or provided in conjunction with such TI products. TI's provision of these resources does not expand or otherwise alter TI's applicable warranties or warranty disclaimers for TI products.

Mailing Address: Texas Instruments, Post Office Box 655303, Dallas, Texas 75265
Copyright © 2019, Texas Instruments Incorporated