

## DCH0105xxx Miniature, 1-W, 3-kV Isolated Unregulated DC/DC Converters

### 1 Features

- Up To 78% Efficiency
- 3-kVDC Isolation (Operational)
- UL60950 Certified Product
- Industry Standard Footprint
- JEDEC 7-Pin SIP Package

### 2 Applications

- Point-of-Use Power Conversions
- Ground Loop Eliminations
- Data Acquisitions
- Industrial Control and Instrumentation
- Test Equipment™

### 3 Description

The DCH010505, DCH010512, and DCH010515 devices are a family of miniature, 1-W, 3-kV isolated DC/DC converters. Featured in an industry standard 7-pin SIP package, the DCH01 series requires minimal external components, reducing board space. The DCH01 series provides both single and dual split-supply outputs.

The use of a highly integrated package design results in highly reliable products with high power densities. High performance and small size makes the DCH01 suitable for a wide range of applications including signal chain applications and ground loop elimination.

#### WARNING

**This product has operational isolation and is intended for signal isolation only. It must not be used as a part of a safety isolation circuit requiring reinforced isolation. See definitions in [Feature Description](#).**

#### Device Information<sup>(1)</sup>

PART NUMBER	PACKAGE	BODY SIZE (NOM)
DCH0105xx	EDJ-Single (7)	19.50 mm x 10.00 mm
	EDJ-Dual (7)	19.50 mm x 10.00 mm

(1) For all available packages, see the orderable addendum at the end of the data sheet.

#### Single-Output Block Diagram

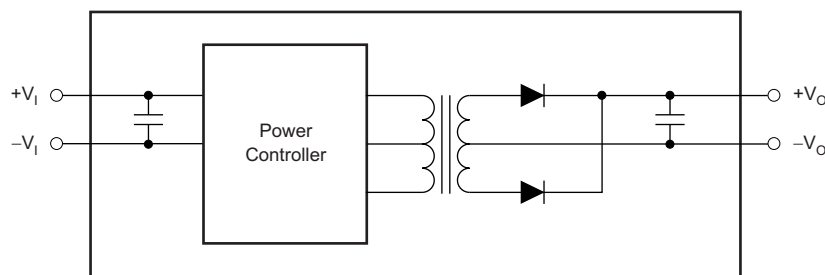

Copyright © 2016, Texas Instruments Incorporated

#### Dual-Output Block Diagram

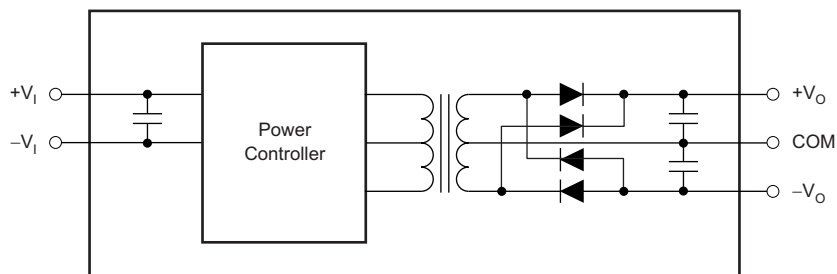

Copyright © 2016, Texas Instruments Incorporated



## Table of Contents

<b>1 Features</b> .....	<b>1</b>	8.3 Feature Description .....	<b>10</b>
<b>2 Applications</b> .....	<b>1</b>	<b>9 Application and Implementation</b> .....	<b>12</b>
<b>3 Description</b> .....	<b>1</b>	9.1 Application Information .....	<b>12</b>
<b>4 Revision History</b> .....	<b>2</b>	9.2 Typical Application .....	<b>15</b>
<b>5 Device Comparison Tables</b> .....	<b>3</b>	<b>10 Power Supply Recommendations</b> .....	<b>16</b>
<b>6 Pin Configuration and Functions</b> .....	<b>3</b>	<b>11 Layout</b> .....	<b>16</b>
<b>7 Specifications</b> .....	<b>4</b>	11.1 Layout Guidelines .....	<b>16</b>
7.1 Absolute Maximum Ratings .....	<b>4</b>	11.2 Layout Example .....	<b>16</b>
7.2 ESD Ratings .....	<b>4</b>	<b>12 Device and Documentation Support</b> .....	<b>17</b>
7.3 Recommended Operating Conditions .....	<b>4</b>	12.1 Related Links .....	<b>17</b>
7.4 Thermal Information .....	<b>4</b>	12.2 Receiving Notification of Documentation Updates .....	<b>17</b>
7.5 Electrical Characteristics .....	<b>5</b>	12.3 Community Resources .....	<b>17</b>
7.6 Typical Characteristics .....	<b>6</b>	12.4 Trademarks .....	<b>17</b>
<b>8 Detailed Description</b> .....	<b>10</b>	12.5 Electrostatic Discharge Caution .....	<b>17</b>
8.1 Overview .....	<b>10</b>	12.6 Glossary .....	<b>17</b>
8.2 Functional Block Diagrams .....	<b>10</b>	<b>13 Mechanical, Packaging, and Orderable Information</b> .....	<b>17</b>

## 4 Revision History

NOTE: Page numbers for previous revisions may differ from page numbers in the current version.

Changes from Revision H (January 2009) to Revision I	Page
• Added <i>ESD Ratings</i> table, <i>Feature Description</i> section, <i>Application and Implementation</i> section, <i>Power Supply Recommendations</i> section, <i>Layout</i> section, <i>Device and Documentation Support</i> section, and <i>Mechanical, Packaging, and Orderable Information</i> section .....	<b>1</b>
• Changed <i>Ordering Information</i> to <i>Device Comparison Tables</i> .....	<b>3</b>
• Deleted Wave soldering temperature (260°C maximum) from <i>Absolute Maximum Ratings</i> table .....	<b>4</b>
• Added <i>Thermal Information</i> table .....	<b>4</b>
• Added <i>Isolation</i> subsection to the <i>Feature Description</i> .....	<b>10</b>

## 5 Device Comparison Tables

**Table 1. DCH01 Products**

MODEL	INPUT VOLTAGE (V)	OUTPUT VOLTAGE (V)	OUTPUT CURRENT (mA)	OUTPUT POWER (W)	ISOLATION VOLTAGE (kVDC)	PACKAGE-LEAD
DCH010505S	5 ± 10%	5	200	1	3	SIP-7
DCH010512S	5 ± 10%	12	83	1	3	SIP-7
DCH010515S	5 ± 10%	15	67	1	3	SIP-7
DCH010505D	5 ± 10%	±5	±100	1	3	SIP-7
DCH010512D	5 ± 10%	±12	±42	1	3	SIP-7
DCH010515D	5 ± 10%	±15	±33	1	3	SIP-7

**Table 2. Part Numbering Scheme**

PRODUCT LINE	POWER	INPUT VOLTAGE	OUTPUT VOLTAGE	SINGLE/DUAL	PACKAGE	PIN CONFIG	TRANSPORT MEDIA
DCH	01	05	05	S	N	7	
H = 3 kV, unregulated output	01 = 1 W	05 = 5 V	05 = 5 V 12 = 12 V 15 = 15 V	S = Single D = Dual	N = SIP Thru-hole	7 = SIP-7	Blank = Tray

## 6 Pin Configuration and Functions

**EDJ Package  
7-Pin SIP (Single)  
Top View**

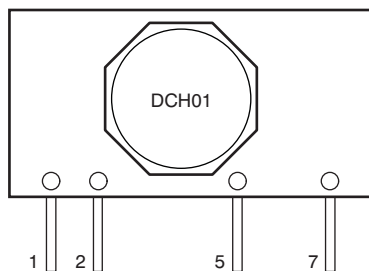

**EDJ Package  
7-Pin SIP (Dual)  
Top View**

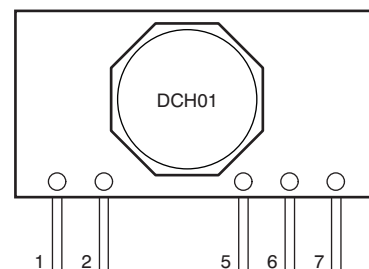

### Pin Functions

NAME	PIN		I/O	DESCRIPTION
	EDJ (SINGLE)	EDJ (DUAL)		
-V <sub>I</sub>	2	2	I	Input side common
+V <sub>I</sub>	1	1	I	Voltage input
-V <sub>O</sub>	5	5	O	-Voltage out
+V <sub>O</sub>	7	7	O	+Voltage out
COM	—	6	—	Output side common

## 7 Specifications

### 7.1 Absolute Maximum Ratings

over operating free-air temperature range (unless otherwise noted)<sup>(1)</sup>

	MIN	MAX	UNIT
Input voltage (5-V input models)		7	V
Storage temperature, $T_{stg}$	-55	125	°C

(1) Stresses beyond those listed under *Absolute Maximum Ratings* may cause permanent damage to the device. These are stress ratings only, which do not imply functional operation of the device at these or any other conditions beyond those indicated under *Recommended Operating Conditions*. Exposure to absolute-maximum-rated conditions for extended periods may affect device reliability.

### 7.2 ESD Ratings

		VALUE	UNIT
$V_{(ESD)}$ Electrostatic discharge	Human-body model (HBM), per ANSI/ESDA/JEDEC JS-001 <sup>(1)</sup>	±2000	V
	Charged-device model (CDM), per JEDEC specification JESD22-C101 <sup>(2)</sup>	±250	

(1) JEDEC document JEP155 states that 500-V HBM allows safe manufacturing with a standard ESD control process.

(2) JEDEC document JEP157 states that 250-V CDM allows safe manufacturing with a standard ESD control process.

### 7.3 Recommended Operating Conditions

over operating free-air temperature range (unless otherwise noted)

	MIN	MAX	UNIT
+ $V_I$ Input voltage	4.5	5.5	V
$T_A$ Operating ambient temperature	-40	85	°C

### 7.4 Thermal Information

THERMAL METRIC <sup>(1)</sup>	DCH01 SERIES		UNIT
	EDJ (SIP-SINGLE)	EDJ (SIP-DUAL)	
	7 PINS	7 PINS	
$R_{\theta JA}$ Junction-to-ambient thermal resistance	66	66	°C/W
$\psi_{JT}$ Junction-to-top characterization parameter	3	3	°C/W
$\psi_{JB}$ Junction-to-board characterization parameter	66	66	°C/W

(1) For more information about traditional and new thermal metrics, see the [Semiconductor and IC Package Thermal Metrics](#) application report.

## 7.5 Electrical Characteristics

 At  $T_A = 25^\circ\text{C}$  and  $V_I = 5\text{ V}$  (unless otherwise noted)

PARAMETER		TEST CONDITIONS		MIN	TYP	MAX	UNIT
$V_I$	Input voltage	All devices nominal			5		V
$V_{\text{NOM}}$	Output voltage	100% load <sup>(1)</sup>	DCH010505S		5.1		V
			DCH010505D		±5.2		
			DCH010512S		12.4		
			DCH010512D		±12.5		
			DCH010515S		15.2		
			DCH010515D		±15.3		
Load regulation		10% to 100% load <sup>(2)</sup>	DCH010505S		10%		
			DCH010505D		9%		
			DCH010512S		6%		
			DCH010512D		5%		
			DCH010515S		6%		
			DCH010515D		5%		
Output ripple		100% LOAD <sup>(1)</sup>	DCH010505S		35		mV <sub>PP</sub>
			DCH010505D		20		
			DCH010512S		18		
			DCH010512D		19		
			DCH010515S		31		
			DCH010515D		22		
$I_Q$	Input current	No load; 0% load	DCH010505x		60		mA
			DCH010512x		65		
			DCH010515x		65		
Efficiency		100% load <sup>(1)</sup>	DCH010505x		72%		
			DCH010512S		74%		
			DCH010512D		75%		
			DCH010515S		75%		
			DCH010515D		76%		
$C_{\text{ISO}}$	Barrier capacitance	DCH010505x & DCH010515x		3		pF	
		DCH010512x		4			
Output power		100% full load			1 <sup>(3)</sup>	W	
		Over current duration <sup>(3)</sup>			1	sec	
Input voltage on $V_I$				-10%		10%	
Isolation voltage		100% tested for 1 second		3.5			kVDC
Line regulation		1% change in $V_I$			1%		
Switching frequency ( $f_{\text{SW}}$ )					70		kHz
Calculated reliability		Per Telcordia SR-332, 50% stress, $T_A = 40^\circ\text{C}$	Single output		18		FITS
			Dual output		22		

 (1) 100% load current = 1 W /  $V_{\text{NOM}}$  typical.

 (2) Load regulation = ( $V_O$  at 10% load –  $V_O$  at 100% load) /  $V_O$  at 100% load.

(3) This converter does not have continuous over-current protection.

## 7.6 Typical Characteristics

at  $T_A = 25^\circ\text{C}$  and  $V_{IN} = 5\text{ V}$  (unless otherwise noted)

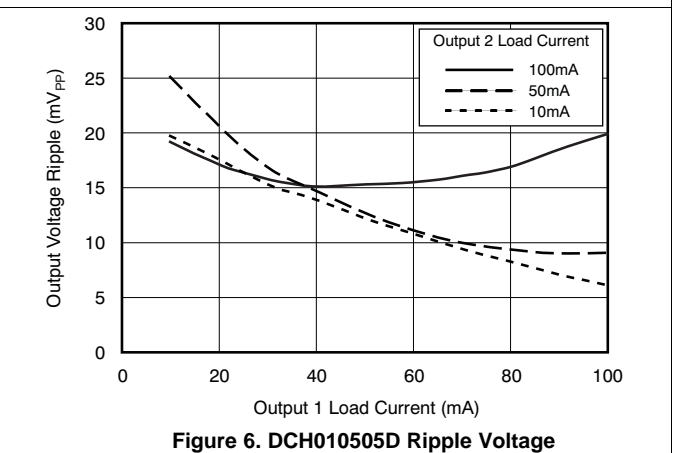
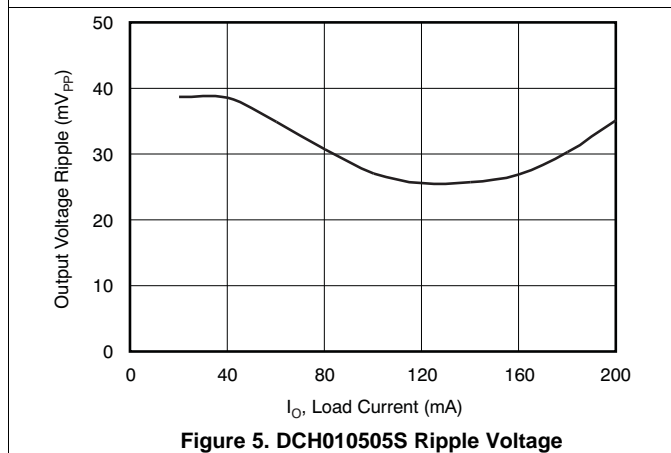
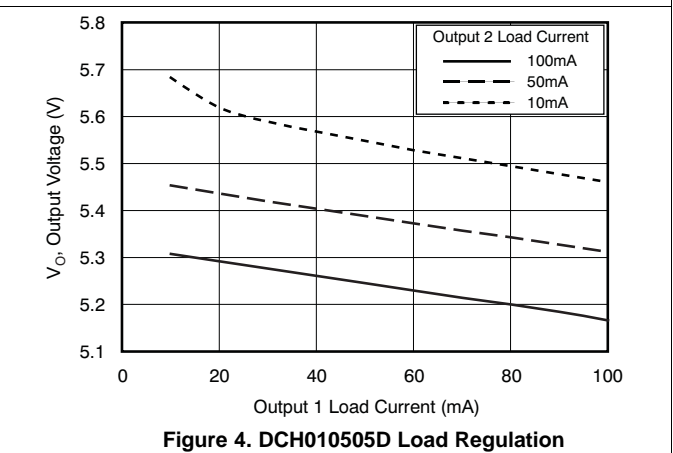
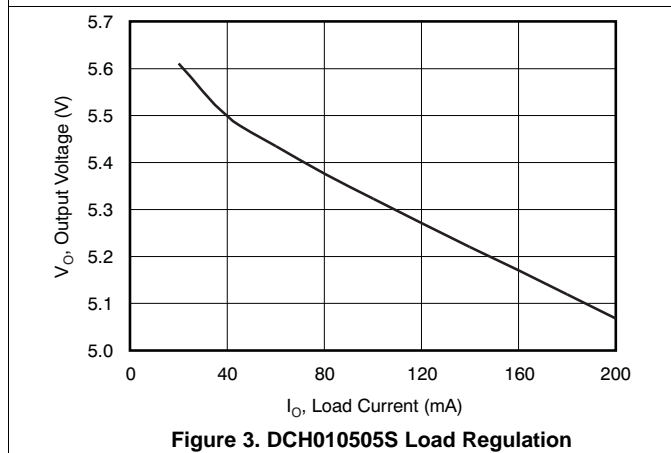
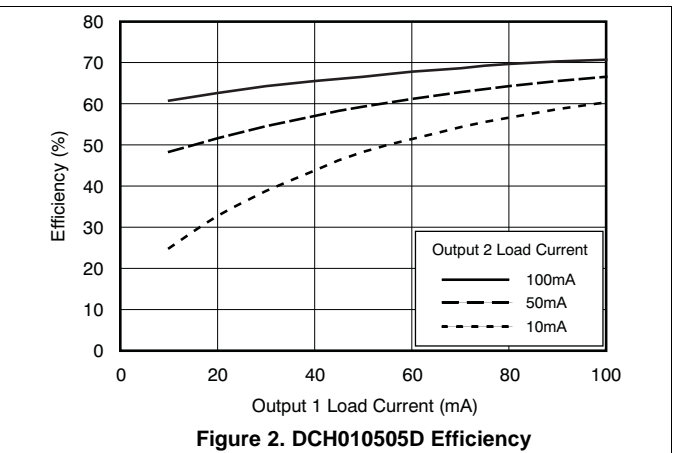
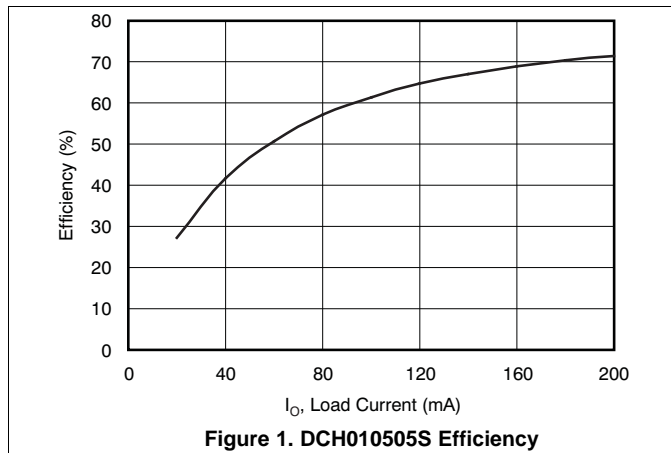

## Typical Characteristics (continued)

at  $T_A = 25^\circ\text{C}$  and  $V_{IN} = 5\text{ V}$  (unless otherwise noted)

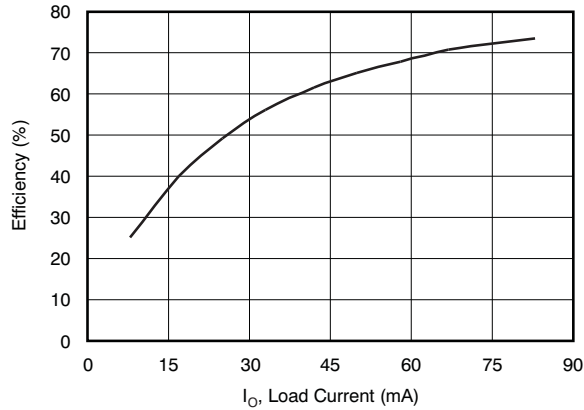

Figure 7. DCH010512S Efficiency

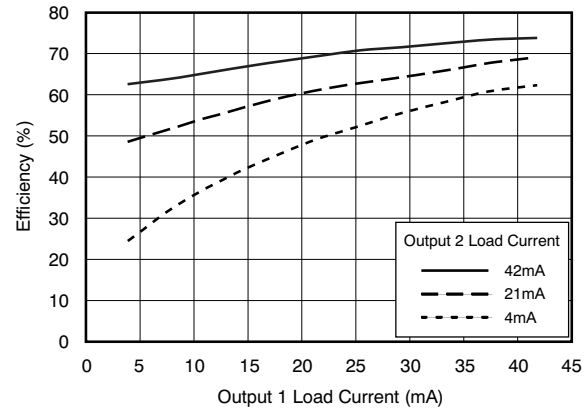

Figure 8. DCH010512D Efficiency

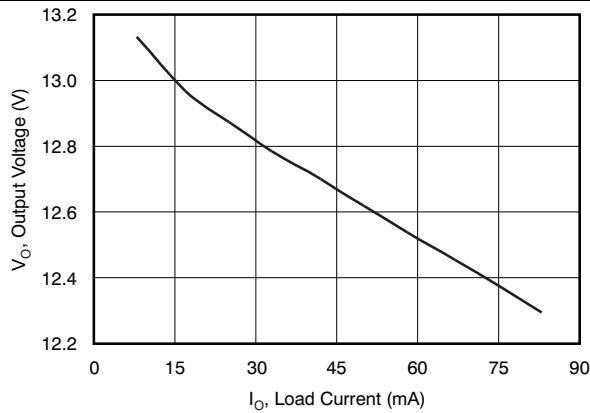

Figure 9. DCH010512S Load Regulation

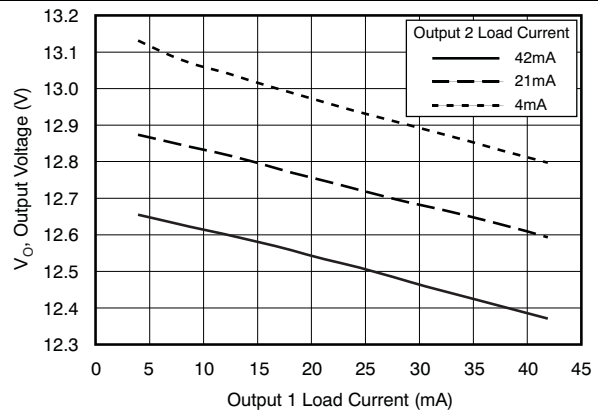

Figure 10. DCH010512D Load Regulation

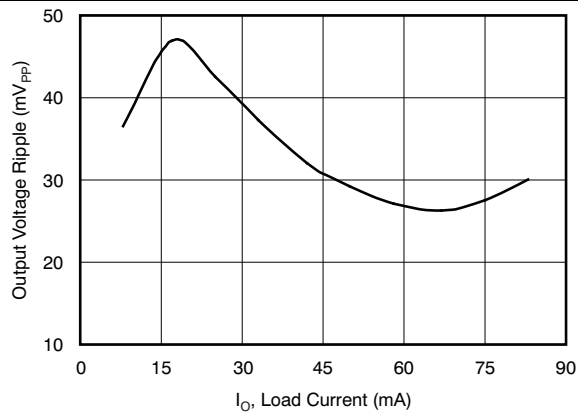

Figure 11. DCH010512S Ripple Voltage

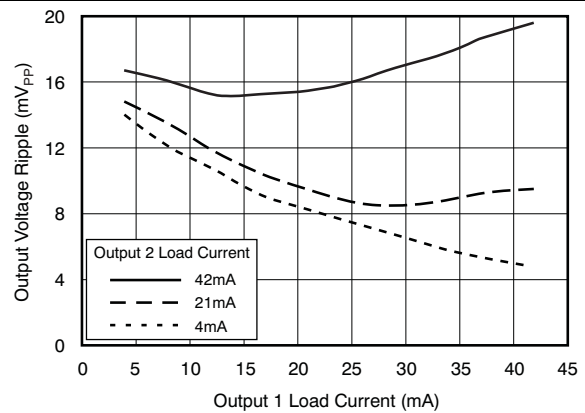

Figure 12. DCH010512D Ripple Voltage

## Typical Characteristics (continued)

at  $T_A = 25^\circ\text{C}$  and  $V_{IN} = 5\text{ V}$  (unless otherwise noted)

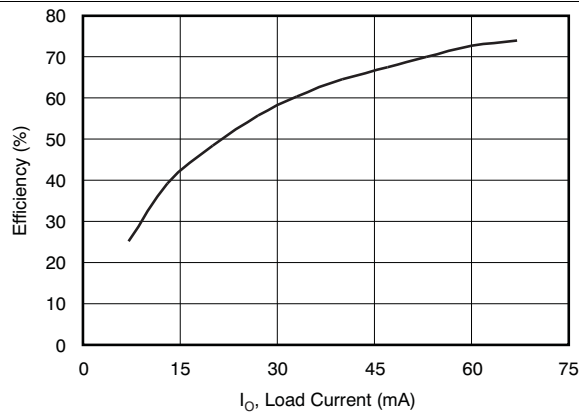

Figure 13. DCH010515S Efficiency

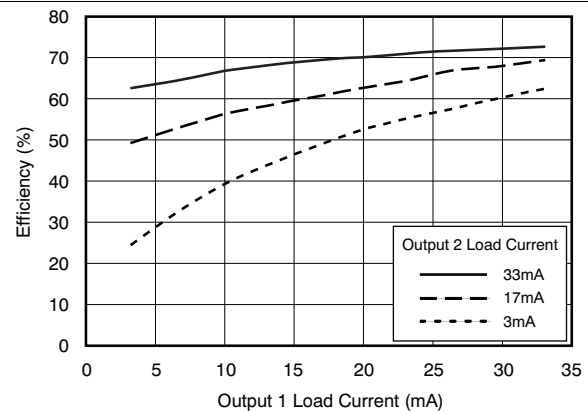

Figure 14. DCH010515D Efficiency

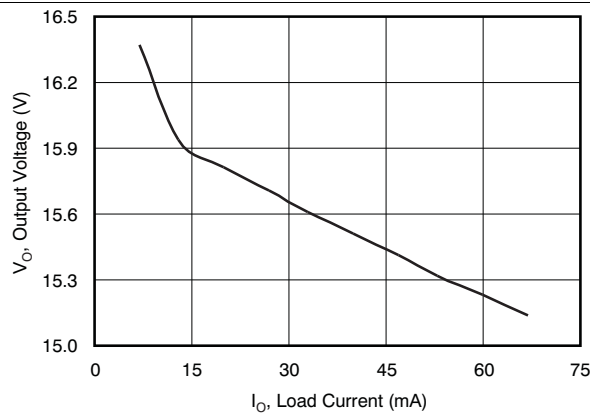

Figure 15. DCH010515S Load Regulation

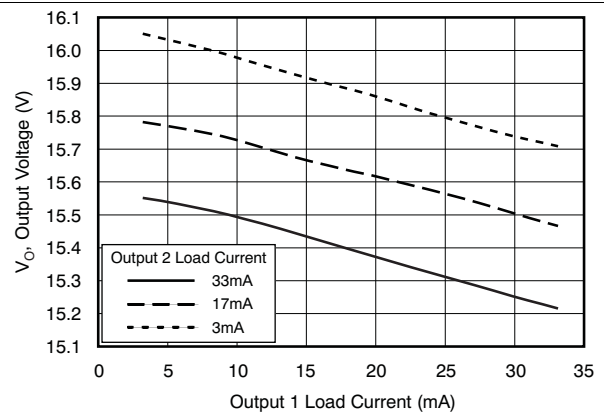

Figure 16. DCH010515D Load Regulation

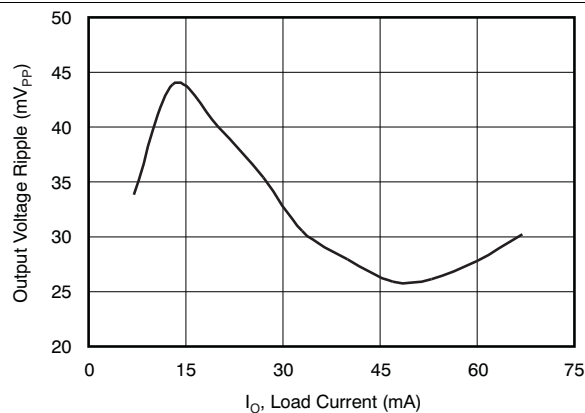

Figure 17. DCH010515S Ripple Voltage

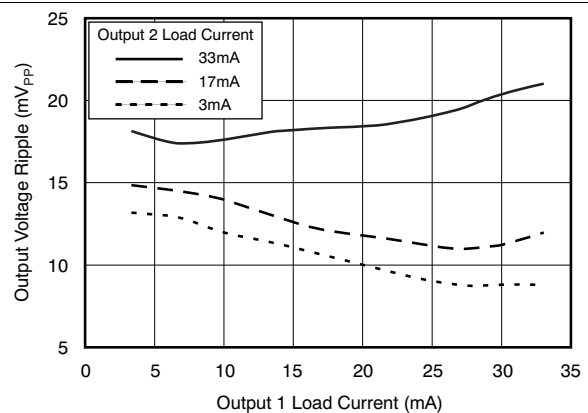
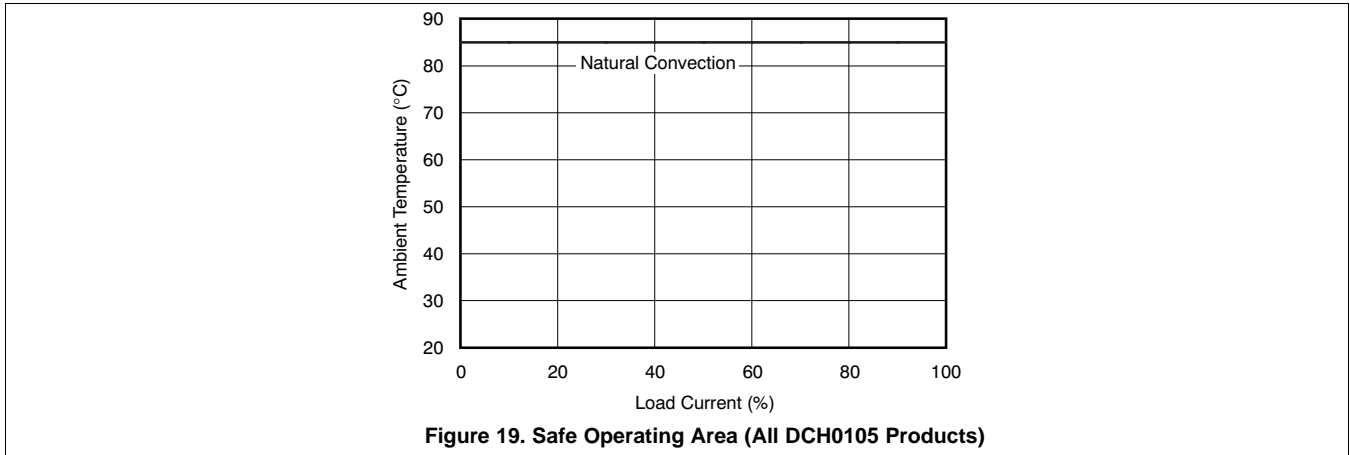

Figure 18. DCH010515D Ripple Voltage



**Typical Characteristics (continued)**

at  $T_A = 25^\circ\text{C}$  and  $V_{IN} = 5\text{ V}$  (unless otherwise noted)



## 8 Detailed Description

### 8.1 Overview

The DCH01 series of DC/DC converters are 100% production tested at 3.5 kVDC for 1 second. The isolation test voltage represents an operational isolation to transient voltages and must not be relied upon for safety isolation.

The continuous voltage that can be applied across the DCH01 during normal operation must be < 60 VDC (within SELV limits).

#### 8.1.1 Repeated High-Voltage Isolation Testing

Repeated high-voltage isolation testing can degrade the isolation capability of the DCH01.

### 8.2 Functional Block Diagrams

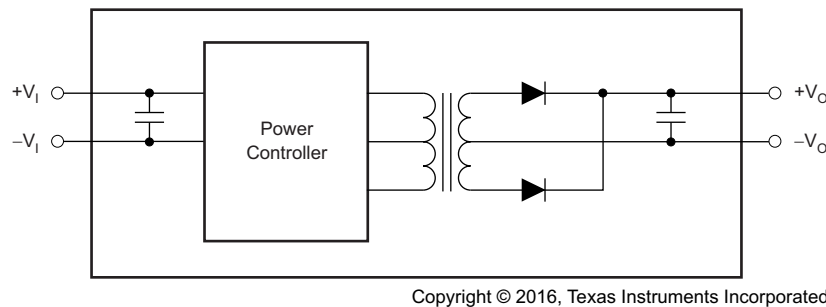

Figure 20. Single-Output Block Diagram

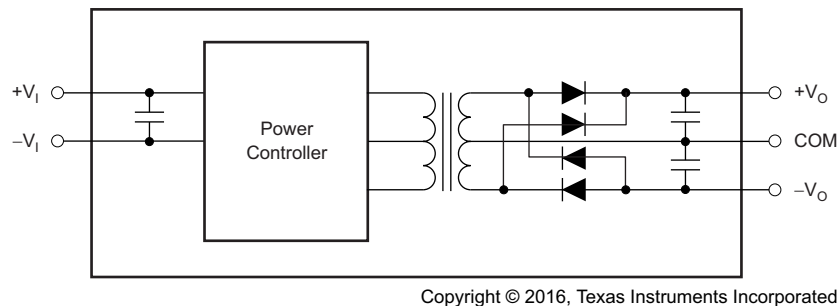

Figure 21. Dual-Output Block Diagram

### 8.3 Feature Description

#### 8.3.1 Isolation

Underwriters Laboratories (UL)<sup>™</sup> defines several classes of isolation that are used in modern power supplies.

*Safety extra low voltage* (SELV) is defined by UL (UL1950 E199929) as a secondary circuit which is so designated and protected that under normal and single fault conditions the voltage between any two accessible parts, or between an accessible part and the equipment earthing terminal for operational isolation does not exceed steady state 42-V peak or 60 V<sub>DC</sub> for more than 1 second.

## Feature Description (continued)

### 8.3.1.1 Operation or Functional Isolation

Operational or functional isolation is defined by the use of a high-potential (hipot) test only. Typically, this isolation is defined as the use of insulated wire in the construction of the transformer as the primary isolation barrier. The hipot one-second duration test (dielectric voltage, withstand test) is a production test used to verify that the isolation barrier is functioning. Products with operational isolation must never be used as an element in a safety-isolation system.

### 8.3.1.2 Basic or Enhanced Isolation

Basic or enhanced isolation is defined by specified creepage and clearance limits between the primary and secondary circuits of the power supply. Basic isolation is the use of an isolation barrier in addition to the insulated wire in the construction of the transformer. Input and output circuits must also be physically separated by specified distances.

### 8.3.1.3 Continuous Voltage

For a device that has no specific safety agency approvals (operational isolation), the continuous voltage that can be applied across the part in normal operation is less than  $42.4 V_{RMS}$  or  $60 V_{DC}$ . Ensure that both input and output voltages maintain normal SELV limits. The isolation test voltage represents a measure of immunity to transient voltages.

#### **WARNING**

**Do not use the device as an element of a safety isolation system when SELV is exceeded.**

If the device is expected to function correctly with more than  $42.4 V_{RMS}$  or  $60 V_{DC}$  applied continuously across the isolation barrier, then the circuitry on both sides of the barrier must be regarded as operating at an unsafe voltage. Further isolation or insulation systems must form a barrier between these circuits and any user-accessible circuitry according to safety standard requirements.

### 8.3.1.4 Isolation Voltage

*Hipot test, flash-tested, withstand voltage, proof voltage, dielectric withstand voltage, and isolation test voltage* are all terms that relate to the same thing: a test voltage applied for a specified time across a component designed to provide electrical isolation to verify the integrity of that isolation. TI's DCH01 series of dc-dc converters are all 100% production tested at  $3.5 kV_{DC}$  for 1 second.

### 8.3.1.5 Repeated High-Voltage Isolation Testing

Repeated high-voltage isolation testing of a barrier component can degrade the isolation capability, depending on materials, construction, and environment. The DCH01 series of dc-dc converters have toroidal, enameled, wire isolation transformers with no additional insulation between the primary and secondary windings. While a device can be expected to withstand several times the stated test voltage, the isolation capability depends on the wire insulation. Any material, including this enamel (typically polyurethane), is susceptible to eventual chemical degradation when subject to very-high applied voltages. Therefore, strictly limit the number of high-voltage tests and repeated high-voltage isolation testing. However, if it is absolutely required, reduce the voltage by 20% from specified test voltage with a duration limit of 1 second per test.

## 9 Application and Implementation

### NOTE

Information in the following applications sections is not part of the TI component specification, and TI does not warrant its accuracy or completeness. TI's customers are responsible for determining suitability of components for their purposes. Customers should validate and test their design implementation to confirm system functionality.

## 9.1 Application Information

### 9.1.1 Optional Input and Output Filters

DCH01 power modules include internal input and output ceramic capacitors in all their designs. However, some applications require much lower levels of either input reflected or output ripple or noise. This application note describes various filters and design techniques found to be successful in reducing both input and output ripple or noise.

#### 9.1.1.1 Input and Output Capacitors

The easiest way to reduce output ripple and noise is to add 1 or more ceramic capacitors each with a value of 4.7- $\mu\text{F}$  or greater. Ceramic capacitors must be placed close to the output power terminals. A single 4.7- $\mu\text{F}$  ceramic capacitor reduces the output ripple or noise by 10% to 30%.

Switching regulators draw current from the input line in pulses at their operating frequency. The amount of reflected (input) ripple or noise generated is directly proportional to the equivalent source impedance of the power source including the impedance of any input lines. The addition of a 4.7- $\mu\text{F}$  ceramic capacitor, near the input power pins, reduces reflected conducted ripple or noise by 30% to 50%.

The recommended maximum capacitive load on the output of the DCH01 is 100  $\mu\text{F}$  (non-ceramic).

#### 9.1.1.2 $\pi$ Filters

If a further reduction in ripple or noise level is required for an application, higher order filters must be used. A  $\pi$  (pi) filter, employing a ferrite bead inductor in series with the input or output terminals of the regulator reduces the ripple or noise by at least 15-20 db (see [Figure 22](#) and [Figure 23](#)). Ceramic capacitors are required for the inductor to be effective in reduction of ripple and noise.

These inductors plus ceramic capacitors form an excellent filter because of the rejection at the switching frequency. The placement of this filter is critical. It must be located as close as possible to the input or output pins to be effective. The ferrite bead is small (5.1 mm x 3 mm), easy to use, low cost, and has low dc resistance. Fair-Rite manufactures a surface-mount bead (part number 2773019447) or through hole (part number 2673000701) rated to 5 A. Inductors with a value from 1  $\mu\text{H}$  to 5  $\mu\text{H}$  can be used in place of the ferrite bead inductor.

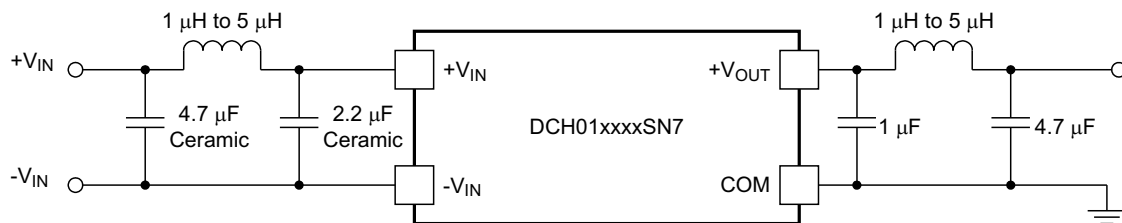

Copyright © 2016, Texas Instruments Incorporated

Figure 22. DCH01 Series  $\pi$  Filter

## Application Information (continued)

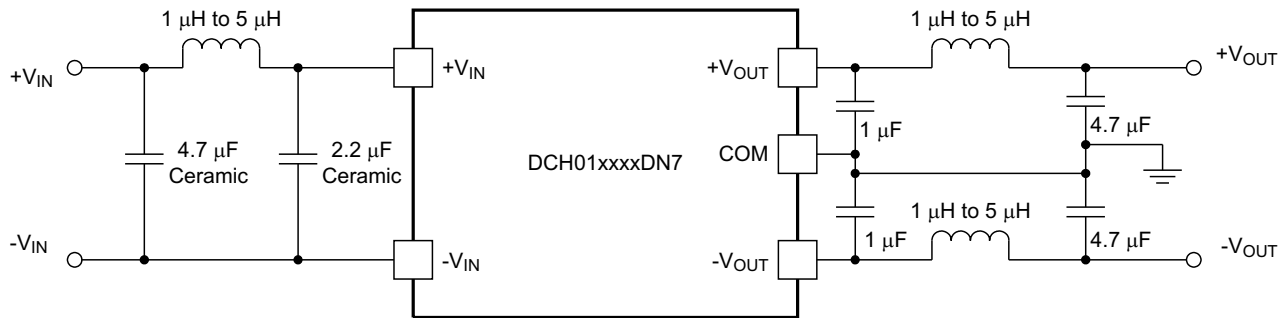

Copyright © 2016, Texas Instruments Incorporated

Figure 23. DCH01 Series  $\pi$  Filter (5 V at 1 W)

### 9.1.2 Start-Up

See Figure 24 for startup waveforms.

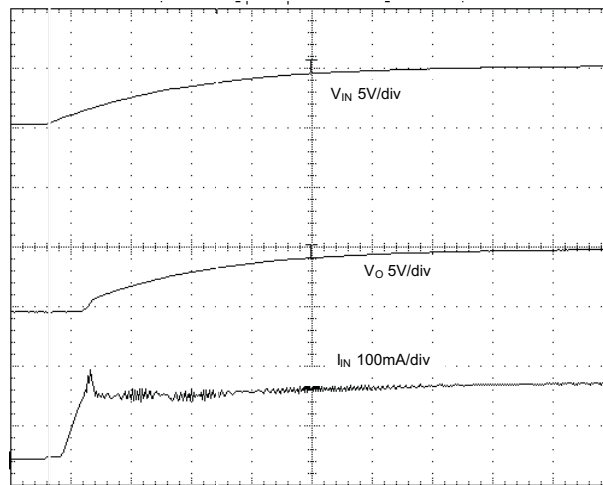
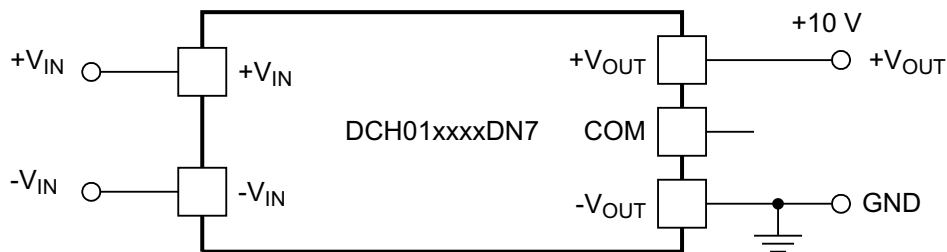

Figure 24. Startup Waveforms

### 9.1.3 Connecting the DCH01 in Series

It is possible to connect the outputs of multiple DCH01s in series to provide non-standard voltage rails. The outputs of dual output DCH01 versions can also be connected in series to provide  $2 \times$  the magnitude of  $V_O$  (as shown in Figure 25). For example, a dual 5-V DCH01 could be connected to provide a 10-V rail.



Copyright © 2016, Texas Instruments Incorporated

Figure 25. Connecting Dual Outputs in Series

### 9.1.4 Connecting the DCH01 in Parallel

If the output power from 1 DCH01 is not sufficient, it is possible to parallel the outputs of multiple DCH01s (as shown in [Figure 26](#)).

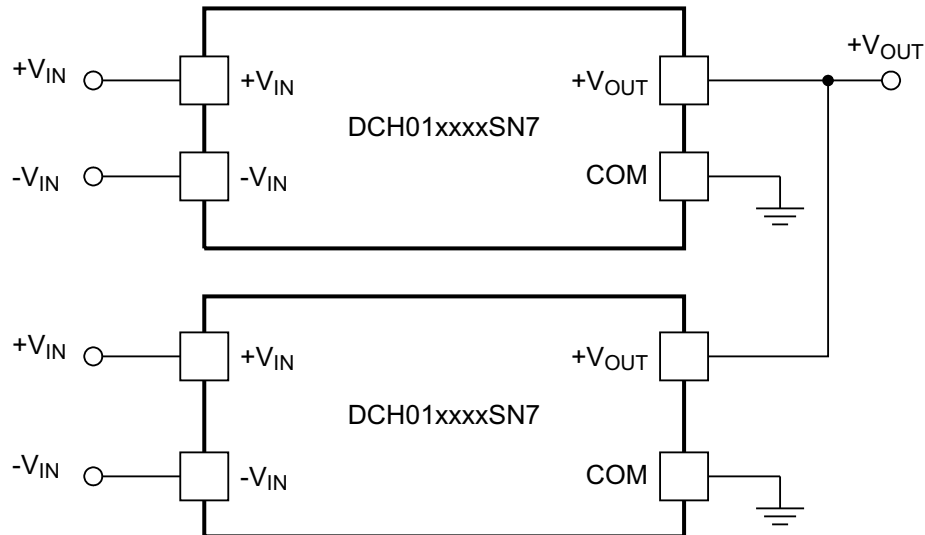

Copyright © 2016, Texas Instruments Incorporated

**Figure 26. Connecting Multiple DCH01s in Parallel**

## 9.2 Typical Application

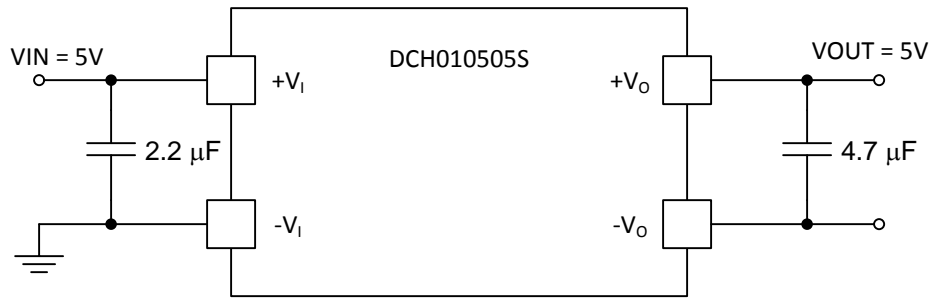

Copyright © 2016, Texas Instruments Incorporated

Figure 27. Typical Application Schematic

### 9.2.1 Design Requirements

For this design example, use the parameters listed in [Table 3](#) and follow the procedures in [Detailed Design Procedure](#).

Table 3. Design Example Parameters

PARAMETER	VALUE
+V <sub>I</sub>	Input voltage 5 V
+V <sub>O</sub>	Output voltage 5 V
I <sub>OUT</sub>	Output current rating 200 mA

### 9.2.2 Detailed Design Procedure

#### 9.2.2.1 Input Capacitor

For any DCH01 design, select a 2.2-μF, low-ESR, ceramic input capacitor to ensure a good startup performance.

#### 9.2.2.2 Output Capacitor

For any DCH01 design, select a 4.7-μF, low-ESR, ceramic output capacitor to reduce output ripple.

### 9.2.3 Application Curves

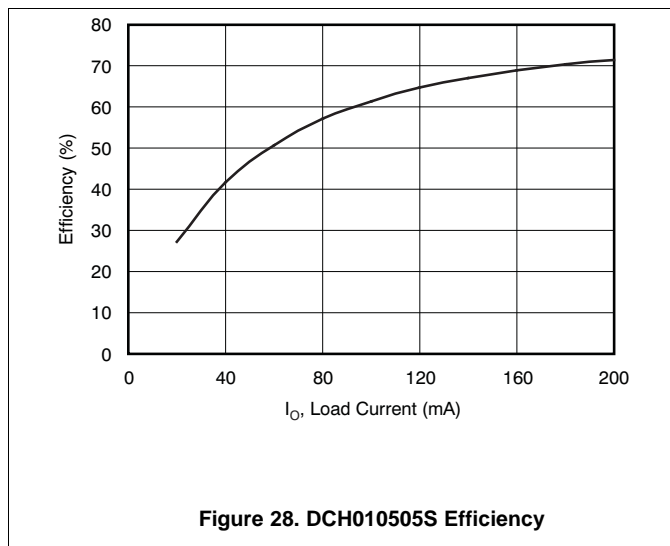

Figure 28. DCH010505S Efficiency

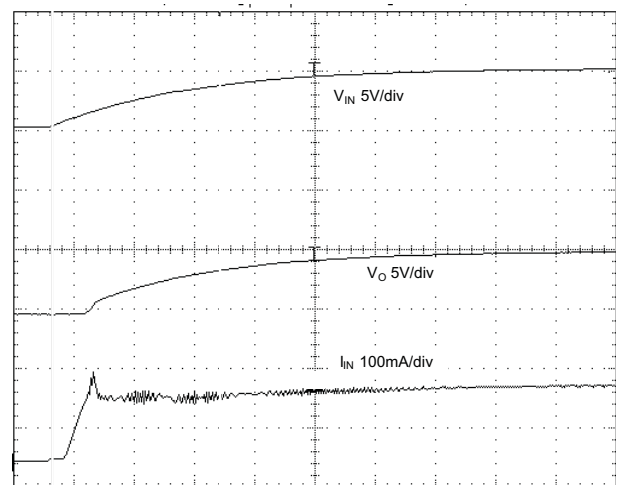

Figure 29. DCH010505 Startup Waveforms

## 10 Power Supply Recommendations

The DCH01 is a switching power supply, and as such can place high peak current demands on the input supply. In order to avoid the supply falling momentarily during the fast switching pulses, ground and power planes must be used to connect the power to the input of DCH01. If this connection is not possible, then the supplies must be connected in a star formation with the traces made as wide as possible.

## 11 Layout

### 11.1 Layout Guidelines

Carefully consider the layout of the PCB in order for the best results to be obtained.

Input and output power and ground planes provide a low-impedance path for the input and output power. For the output, the positive and negative voltage outputs conduct through wide traces to minimize losses.

A good-quality, low-ESR, ceramic capacitor placed as close as practical across the input reduces reflected ripple and ensure a smooth start-up.

The location of the decoupling capacitors in close proximity to their respective pins ensures low losses due to the effects of stray inductance, thus improving the ripple performance. This location is of particular importance to the input decoupling capacitor, because this capacitor supplies the transient current associated with the fast switching waveforms of the power drive circuits.

### 11.2 Layout Example

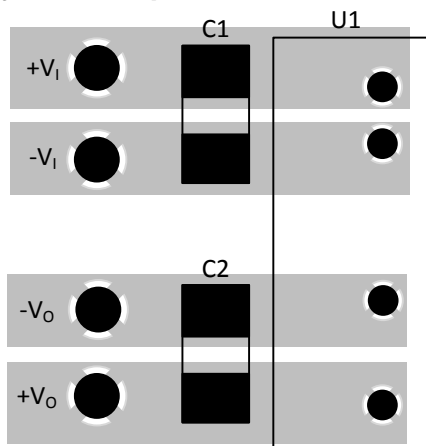

Figure 30. DCH01 Single Output Layout (Component-Side View)

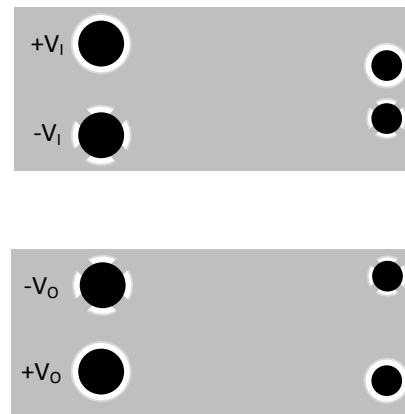

Figure 31. DCH01 Single Output Layout (Non-Component-Side View)



## 12 Device and Documentation Support

### 12.1 Related Links

The table below lists quick access links. Categories include technical documents, support and community resources, tools and software, and quick access to sample or buy.

**Table 4. Related Links**

PARTS	PRODUCT FOLDER	SAMPLE & BUY	TECHNICAL DOCUMENTS	TOOLS & SOFTWARE	SUPPORT & COMMUNITY
DCH010505D	<a href="#">Click here</a>	<a href="#">Click here</a>	<a href="#">Click here</a>	<a href="#">Click here</a>	<a href="#">Click here</a>
DCH010505S	<a href="#">Click here</a>	<a href="#">Click here</a>	<a href="#">Click here</a>	<a href="#">Click here</a>	<a href="#">Click here</a>
DCH010512D	<a href="#">Click here</a>	<a href="#">Click here</a>	<a href="#">Click here</a>	<a href="#">Click here</a>	<a href="#">Click here</a>
DCH010512S	<a href="#">Click here</a>	<a href="#">Click here</a>	<a href="#">Click here</a>	<a href="#">Click here</a>	<a href="#">Click here</a>
DCH010515D	<a href="#">Click here</a>	<a href="#">Click here</a>	<a href="#">Click here</a>	<a href="#">Click here</a>	<a href="#">Click here</a>
DCH010515S	<a href="#">Click here</a>	<a href="#">Click here</a>	<a href="#">Click here</a>	<a href="#">Click here</a>	<a href="#">Click here</a>

### 12.2 Receiving Notification of Documentation Updates

To receive notification of documentation updates, navigate to the device product folder on ti.com. In the upper right corner, click on *Alert me* to register and receive a weekly digest of any product information that has changed. For change details, review the revision history included in any revised document.

### 12.3 Community Resources

The following links connect to TI community resources. Linked contents are provided "AS IS" by the respective contributors. They do not constitute TI specifications and do not necessarily reflect TI's views; see TI's [Terms of Use](#).

**TI E2E™ Online Community** *TI's Engineer-to-Engineer (E2E) Community*. Created to foster collaboration among engineers. At e2e.ti.com, you can ask questions, share knowledge, explore ideas and help solve problems with fellow engineers.

**Design Support** *TI's Design Support* Quickly find helpful E2E forums along with design support tools and contact information for technical support.

### 12.4 Trademarks

Test Equipment, E2E are trademarks of Texas Instruments.  
Underwriters Laboratories (UL) is a trademark of UL LLC.  
All other trademarks are the property of their respective owners.

### 12.5 Electrostatic Discharge Caution



These devices have limited built-in ESD protection. The leads should be shorted together or the device placed in conductive foam during storage or handling to prevent electrostatic damage to the MOS gates.

### 12.6 Glossary

[SLYZ022](#) — *TI Glossary*.

This glossary lists and explains terms, acronyms, and definitions.

## 13 Mechanical, Packaging, and Orderable Information

The following pages include mechanical, packaging, and orderable information. This information is the most current data available for the designated devices. This data is subject to change without notice and revision of this document. For browser-based versions of this data sheet, refer to the left-hand navigation.

**PACKAGING INFORMATION**

Orderable Device	Status (1)	Package Type	Package Drawing	Pins	Package Qty	Eco Plan (2)	Lead/Ball Finish (6)	MSL Peak Temp (3)	Op Temp (°C)	Device Marking (4/5)	Samples
DCH010505DN7	ACTIVE	SIP MODULE	EDJ	5	70	RoHS (In Work) & Green (In Work)	Call TI	N / A for Pkg Type	-40 to 85		<a href="#">Samples</a>
DCH010505SN7	ACTIVE	SIP MODULE	EDJ	4	70	RoHS (In Work) & Green	Call TI	N / A for Pkg Type	-40 to 85		<a href="#">Samples</a>
DCH010512DN7	ACTIVE	SIP MODULE	EDJ	5	70	RoHS (In Work) & Green (In Work)	Call TI	N / A for Pkg Type	-40 to 85		<a href="#">Samples</a>
DCH010512SN7	ACTIVE	SIP MODULE	EDJ	4	70	RoHS (In Work) & Green	Call TI	N / A for Pkg Type	-40 to 85		<a href="#">Samples</a>
DCH010515DN7	ACTIVE	SIP MODULE	EDJ	5	70	RoHS (In Work) & Green (In Work)	Call TI	N / A for Pkg Type	-40 to 85		<a href="#">Samples</a>
DCH010515SN7	ACTIVE	SIP MODULE	EDJ	4	70	RoHS (In Work) & Green	Call TI	N / A for Pkg Type	-40 to 85		<a href="#">Samples</a>

(1) The marketing status values are defined as follows:

**ACTIVE:** Product device recommended for new designs.

**LIFEBUY:** TI has announced that the device will be discontinued, and a lifetime-buy period is in effect.

**NRND:** Not recommended for new designs. Device is in production to support existing customers, but TI does not recommend using this part in a new design.

**PREVIEW:** Device has been announced but is not in production. Samples may or may not be available.

**OBSOLETE:** TI has discontinued the production of the device.

(2) **RoHS:** TI defines "RoHS" to mean semiconductor products that are compliant with the current EU RoHS requirements for all 10 RoHS substances, including the requirement that RoHS substance do not exceed 0.1% by weight in homogeneous materials. Where designed to be soldered at high temperatures, "RoHS" products are suitable for use in specified lead-free processes. TI may reference these types of products as "Pb-Free".

**RoHS Exempt:** TI defines "RoHS Exempt" to mean products that contain lead but are compliant with EU RoHS pursuant to a specific EU RoHS exemption.

**Green:** TI defines "Green" to mean the content of Chlorine (Cl) and Bromine (Br) based flame retardants meet JS709B low halogen requirements of <=1000ppm threshold. Antimony trioxide based flame retardants must also meet the <=1000ppm threshold requirement.

(3) MSL, Peak Temp. - The Moisture Sensitivity Level rating according to the JEDEC industry standard classifications, and peak solder temperature.

(4) There may be additional marking, which relates to the logo, the lot trace code information, or the environmental category on the device.

(5) Multiple Device Markings will be inside parentheses. Only one Device Marking contained in parentheses and separated by a "~" will appear on a device. If a line is indented then it is a continuation of the previous line and the two combined represent the entire Device Marking for that device.

<sup>(6)</sup> Lead/Ball Finish - Orderable Devices may have multiple material finish options. Finish options are separated by a vertical ruled line. Lead/Ball Finish values may wrap to two lines if the finish value exceeds the maximum column width.

**Important Information and Disclaimer:** The information provided on this page represents TI's knowledge and belief as of the date that it is provided. TI bases its knowledge and belief on information provided by third parties, and makes no representation or warranty as to the accuracy of such information. Efforts are underway to better integrate information from third parties. TI has taken and continues to take reasonable steps to provide representative and accurate information but may not have conducted destructive testing or chemical analysis on incoming materials and chemicals. TI and TI suppliers consider certain information to be proprietary, and thus CAS numbers and other limited information may not be available for release.

In no event shall TI's liability arising out of such information exceed the total purchase price of the TI part(s) at issue in this document sold by TI to Customer on an annual basis.

**EDJ (R-PDSS-T5)**

**DOUBLE SIDED MODULE**

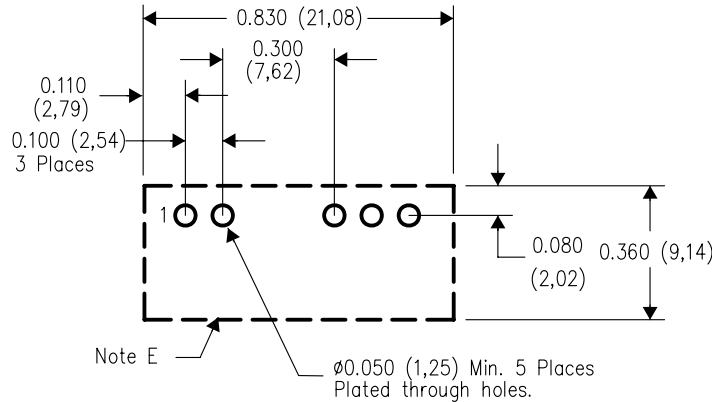
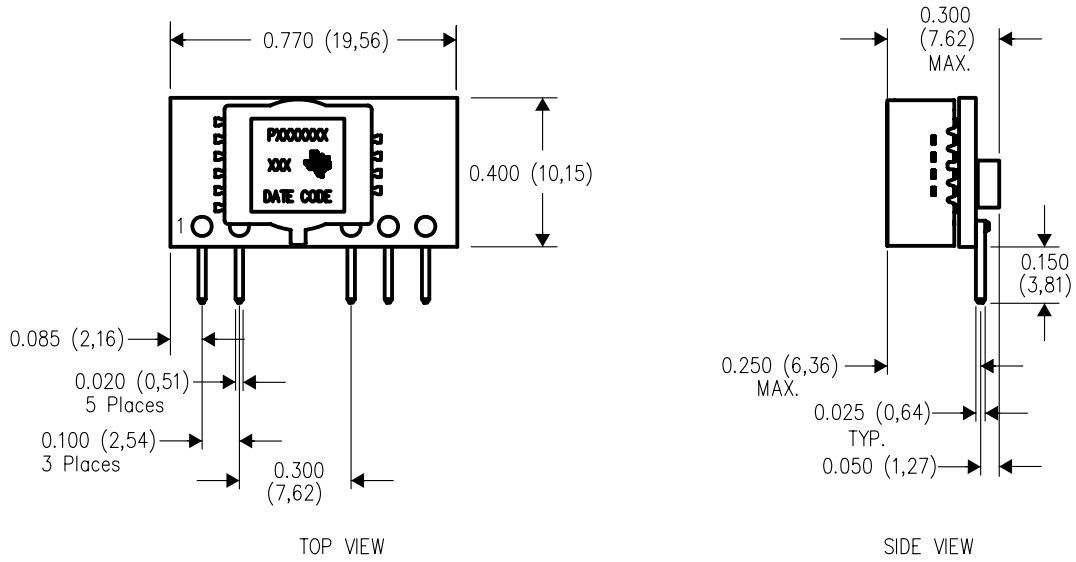

4207975-3/C 08/07

- NOTES:
- A. All linear dimensions are in inches (mm).
  - B. This drawing is subject to change without notice.
  - C. 2 place decimals are  $\pm 0.030$  ( $\pm 0,76$ mm).
  - D. 3 place decimals are  $\pm 0.010$  ( $\pm 0,25$ mm).
  - E. Recommended keep out area for user components.
  - F. Pins are 0.020" (0,51) x 0.025" (0,64).
  - G. All pins: Material - Copper Alloy  
Finish - Tin (100%) over Nickel plate

**EDJ (R-PDSS-T4)**

**DOUBLE SIDED MODULE**

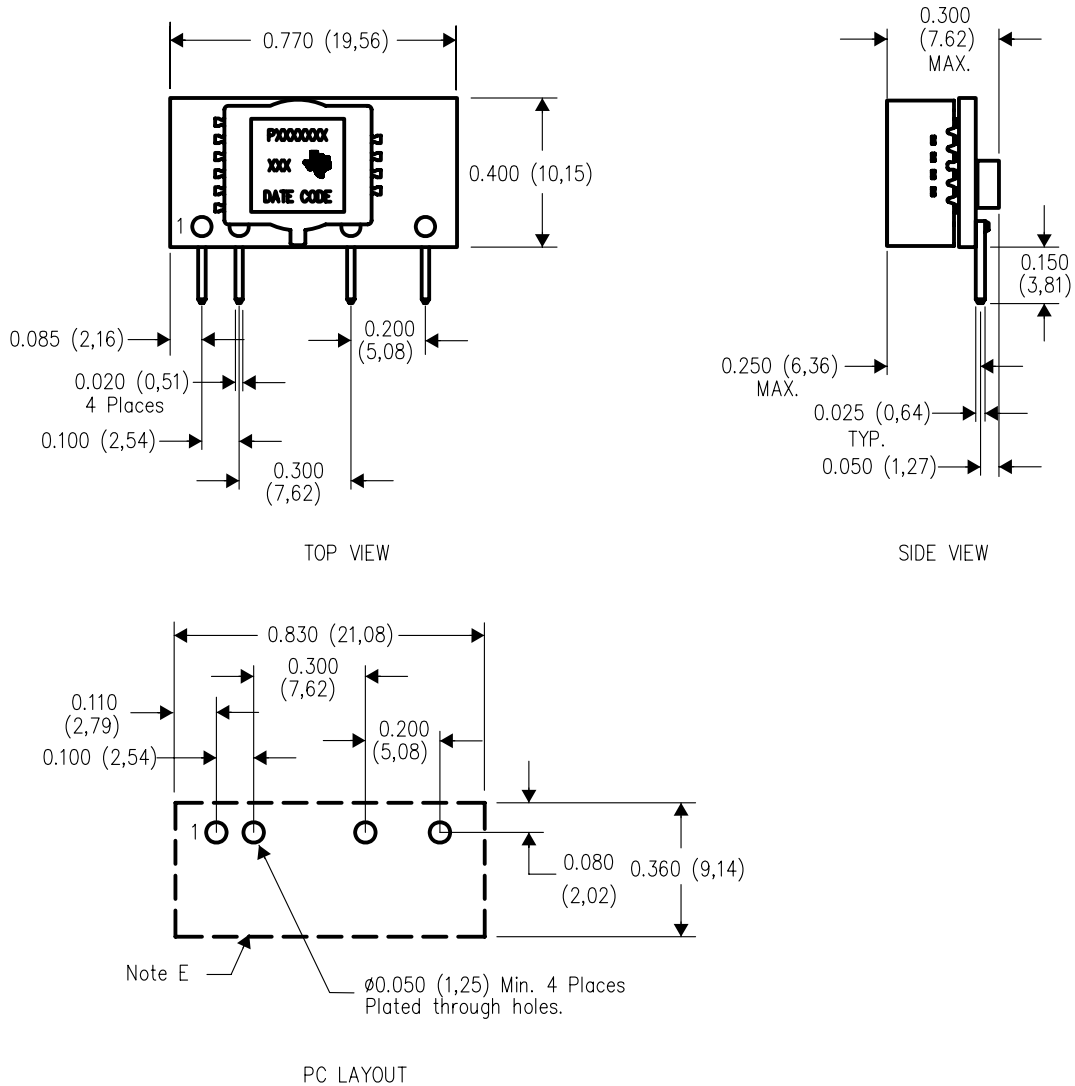

4207975-2/C 08/07

- NOTES:
- A. All linear dimensions are in inches (mm).
  - B. This drawing is subject to change without notice.
  - C. 2 place decimals are  $\pm 0.030$  ( $\pm 0,76$ mm).
  - D. 3 place decimals are  $\pm 0.010$  ( $\pm 0,25$ mm).
  - E. Recommended keep out area for user components.
  - F. Pins are 0.020" (0,51) x 0.025" (0,64).
  - G. All pins: Material - Copper Alloy  
Finish - Tin (100%) over Nickel plate

## IMPORTANT NOTICE AND DISCLAIMER

TI PROVIDES TECHNICAL AND RELIABILITY DATA (INCLUDING DATASHEETS), DESIGN RESOURCES (INCLUDING REFERENCE DESIGNS), APPLICATION OR OTHER DESIGN ADVICE, WEB TOOLS, SAFETY INFORMATION, AND OTHER RESOURCES "AS IS" AND WITH ALL FAULTS, AND DISCLAIMS ALL WARRANTIES, EXPRESS AND IMPLIED, INCLUDING WITHOUT LIMITATION ANY IMPLIED WARRANTIES OF MERCHANTABILITY, FITNESS FOR A PARTICULAR PURPOSE OR NON-INFRINGEMENT OF THIRD PARTY INTELLECTUAL PROPERTY RIGHTS.

These resources are intended for skilled developers designing with TI products. You are solely responsible for (1) selecting the appropriate TI products for your application, (2) designing, validating and testing your application, and (3) ensuring your application meets applicable standards, and any other safety, security, or other requirements. These resources are subject to change without notice. TI grants you permission to use these resources only for development of an application that uses the TI products described in the resource. Other reproduction and display of these resources is prohibited. No license is granted to any other TI intellectual property right or to any third party intellectual property right. TI disclaims responsibility for, and you will fully indemnify TI and its representatives against, any claims, damages, costs, losses, and liabilities arising out of your use of these resources.

TI's products are provided subject to TI's Terms of Sale ([www.ti.com/legal/termsofsale.html](http://www.ti.com/legal/termsofsale.html)) or other applicable terms available either on [ti.com](http://ti.com) or provided in conjunction with such TI products. TI's provision of these resources does not expand or otherwise alter TI's applicable warranties or warranty disclaimers for TI products.

Mailing Address: Texas Instruments, Post Office Box 655303, Dallas, Texas 75265  
Copyright © 2020, Texas Instruments Incorporated