

20Mbps and Slew Rate Limited 15kV RS485/RS422 Transceivers

FEATURES

- 20Mbps or Low EMI 250kbps Maximum Data Rate
- No Damage or Latchup to ESD: $\pm 15\text{kV}$ HBM
- High Input Impedance Supports 256 Nodes (C, I-Grade)
- Operation Up to 125°C (H-Grade)
- Guaranteed Failsafe Receiver Operation Over the Entire Common Mode Range
- Current Limited Drivers and Thermal Shutdown
- Delayed Micropower Shutdown: $5\mu\text{A}$ Maximum (C, I-Grade)
- Power Up/Down Glitch-Free Driver Outputs
- Low Operating Current: $900\mu\text{A}$ Maximum in Receive Mode
- Compatible with TIA/EIA-485-A Specifications
- Available in 8-Lead and 10-Lead $3\text{mm} \times 3\text{mm}$ DFN and 8-Lead and 10-Lead MSOP Packages

APPLICATIONS

- Low Power RS485/RS422 Transceiver
- Level Translator
- Backplane Transceiver

LT, LT, LTC, LTM, Linear Technology and the Linear logo are registered trademarks of Analog Devices, Inc. All other trademarks are the property of their respective owners.

DESCRIPTION

The LTC[®]2856-1, LTC2856-2, LTC2857-1, LTC2857-2, LTC2858-1 and LTC2858-2 are low power, RS485/RS422 transceivers operating on 5V supplies at maximum data rates of 20Mbps or 250kbps for low EMI. The receiver has a one-eighth unit load, supporting up to 256 nodes per bus (C, I-Grade), and a failsafe feature that guarantees a high output state under conditions of floating or shorted inputs.

The driver maintains a high output impedance over the entire common mode range when disabled or when the supply is removed. Excessive power dissipation caused by bus contention or a fault is prevented by current limiting all outputs and by thermal shutdown.

Enhanced ESD protection allows these parts to withstand $\pm 15\text{kV}$ (human body model) on the transceiver interface pins without latchup or damage.

| PART NUMBER | MAX DATA RATE (Mbps) | DUPLEX | PACKAGE |
|-------------|----------------------|--------|-----------------|
| LTC2856-1 | 20 | Half | MSOP-8, DFN-8 |
| LTC2856-2 | 0.25 | Half | MSOP-8, DFN-8 |
| LTC2857-1 | 20 | Full | MSOP-8, DFN-8 |
| LTC2857-2 | 0.25 | Full | MSOP-8, DFN-8 |
| LTC2858-1 | 20 | Full | MSOP-10, DFN-10 |
| LTC2858-2 | 0.25 | Full | MSOP-10, DFN-10 |

TYPICAL APPLICATION

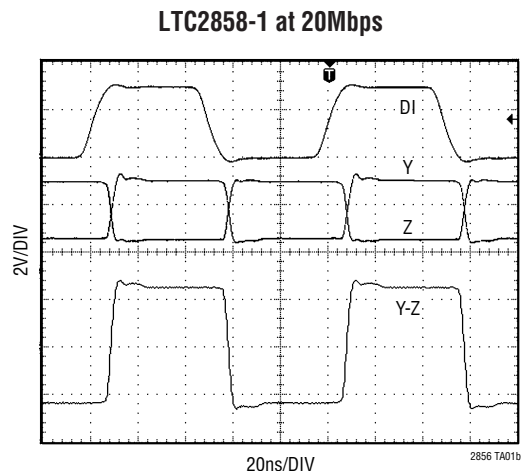
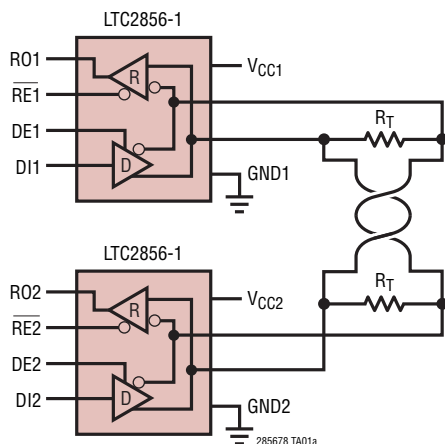

LTC2856-1/LTC2856-2

LTC2857-1/LTC2857-2

LTC2858-1/LTC2858-2

ABSOLUTE MAXIMUM RATINGS

(Note 1)

| | |
|--|------------------------------|
| Supply Voltage (V_{CC}) | -0.3V to 7V |
| Logic Input Voltages (\overline{RE} , DE, DI) | -0.3V to 7V |
| Interface I/O (A, B, Y, Z) | ($V_{CC} - 15V$) to 15V |
| Receiver Output Voltage (RO) | -0.3V to ($V_{CC} + 0.3V$) |
| Operating Temperature Range (Note 4) | |
| LTC285xC | 0°C to 70°C |
| LTC285xI | -40°C to 85°C |
| LTC285xH | -40°C to 125°C |

Storage Temperature Range

| | |
|--------------------------------------|----------------|
| MSOP | -65°C to 150°C |
| DFN | -65°C to 150°C |
| Lead Temperature (Soldering, 10 sec) | |
| MSOP | 300°C |

PACKAGE INFORMATION

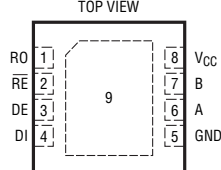
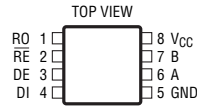
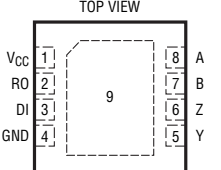
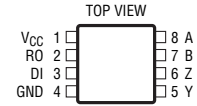
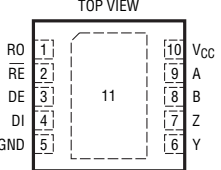
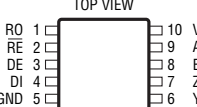
| | |
|--|---|
| <p>LTC2856</p>  <p>DD PACKAGE 8-LEAD (3mm × 3mm) PLASTIC DFN</p> <p>EXPOSED PAD (PIN 9) IS GND, MUST BE SOLDERED TO PCB $T_{JMAX} = 150^{\circ}C$, $\theta_{JA} = 43^{\circ}C/W$, $\theta_{JC} = 5.5^{\circ}C/W$</p> |  <p>MS8 PACKAGE 8-LEAD PLASTIC MSOP</p> <p>$T_{JMAX} = 150^{\circ}C$, $\theta_{JA} = 163^{\circ}C/W$, $\theta_{JC} = 40^{\circ}C/W$</p> |
| <p>LTC2857</p>  <p>DD PACKAGE 8-LEAD (3mm × 3mm) PLASTIC DFN</p> <p>EXPOSED PAD (PIN 9) IS GND, MUST BE SOLDERED TO PCB $T_{JMAX} = 150^{\circ}C$, $\theta_{JA} = 43^{\circ}C/W$, $\theta_{JC} = 5.5^{\circ}C/W$</p> |  <p>MS8 PACKAGE 8-LEAD PLASTIC MSOP</p> <p>$T_{JMAX} = 150^{\circ}C$, $\theta_{JA} = 163^{\circ}C/W$, $\theta_{JC} = 40^{\circ}C/W$</p> |
| <p>LTC2858</p>  <p>DD PACKAGE 10-LEAD (3mm × 3mm) PLASTIC DFN</p> <p>EXPOSED PAD (PIN 11) IS GND, MUST BE SOLDERED TO PCB $T_{JMAX} = 150^{\circ}C$, $\theta_{JA} = 43^{\circ}C/W$, $\theta_{JC} = 5.5^{\circ}C/W$</p> |  <p>MS PACKAGE 10-LEAD PLASTIC MSOP</p> <p>$T_{JMAX} = 150^{\circ}C$, $\theta_{JA} = 160^{\circ}C/W$, $\theta_{JC} = 45^{\circ}C/W$</p> |

ORDER INFORMATION

<http://www.linear.com/product/LTC2856-1#orderinfo>

LTC2856 C DD -1 #TR PBF

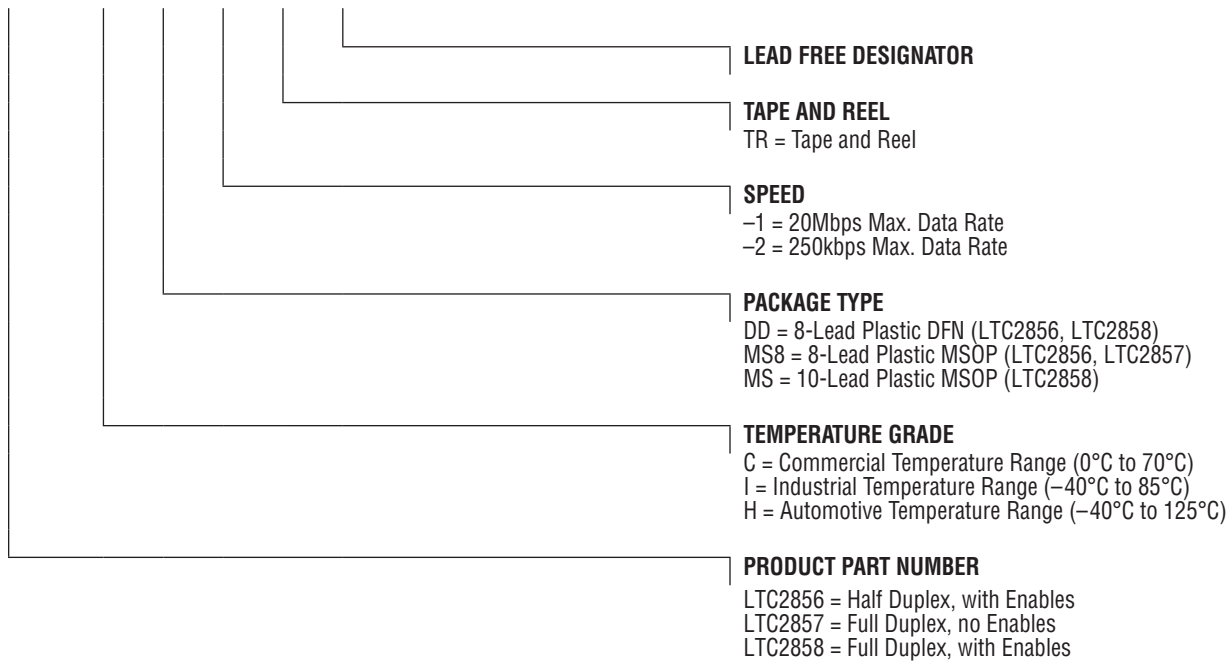

Consult LTC Marketing for parts specified with wider operating temperature ranges.

For more information on lead free part marking, go to: <http://www.linear.com/leadfree/>

For more information on tape and reel specifications, go to: <http://www.linear.com/tapeandree/>. Some packages are available in 500 unit reels through designated sales channels with #TRMPBF suffix.

PRODUCT SELECTION GUIDE

| PART NUMBER | PART MARKING | MAX DATA RATE (Mbps) | DUPLEX | LOW POWER SHUTDOWN MODE | PACKAGE |
|-------------|--------------|----------------------|--------|-------------------------|-----------------|
| LTC2856-1 | LTCMF, LCMG | 20 | Half | Yes | MSOP-8, DFN-8 |
| LTC2856-2 | LTCMH, LCMJ | 0.25 | Half | Yes | MSOP-8, DFN-8 |
| LTC2857-1 | LTCMC, LCMD | 20 | Full | No | MSOP-8, DFN-8 |
| LTC2857-2 | LTCMK, LCMM | 0.25 | Full | No | MSOP-8, DFN-8 |
| LTC2858-1 | LTCGQ, LCGR | 20 | Full | Yes | MSOP-10, DFN-10 |
| LTC2858-2 | LTCMQ, LCMR | 0.25 | Full | Yes | MSOP-10, DFN-10 |

LTC2856-1/LTC2856-2
LTC2857-1/LTC2857-2
LTC2858-1/LTC2858-2

ELECTRICAL CHARACTERISTICS The ● denotes the specifications which apply over the full operating temperature range, otherwise specifications are at $T_A = 25^\circ\text{C}$. $V_{CC} = 5\text{V}$ unless otherwise noted. (Note 2)

| SYMBOL | PARAMETER | CONDITIONS | MIN | TYP | MAX | UNITS |
|------------------|---|---|-----|-----------|---------------|------------------|
| Driver | | | | | | |
| $ V_{OD} $ | Differential Driver Output Voltage | $R = \infty$, $V_{CC} = 4.5\text{V}$ (Figure 1) | ● | | V_{CC} | V |
| | | $R = 27\Omega$ (RS485), $V_{CC} = 4.5\text{V}$ (Figure 1) | ● | 1.5 | V_{CC} | V |
| | | $R = 50\Omega$ (RS422), $V_{CC} = 4.5\text{V}$ (Figure 1) | ● | 2 | V_{CC} | V |
| $\Delta V_{OD} $ | Change in Magnitude of Driver Differential Output Voltage for Complementary Output States | $R = 27\Omega$ or $R = 50\Omega$ (Figure 1) | ● | | 0.2 | V |
| V_{OC} | Driver Common Mode Output Voltage | $R = 27\Omega$ or $R = 50\Omega$ (Figure 1) | ● | | 3 | V |
| $\Delta V_{OC} $ | Change in Magnitude of Driver Common Mode Output Voltage for Complementary Output States | $R = 27\Omega$ or $R = 50\Omega$ (Figure 1) | ● | | 0.2 | V |
| I_{OZD} | Driver Three-State (High Impedance) Output Current on Y and Z | $DE = 0\text{V}$, (Y or Z) = -7V , 12V , LTC2858-1, LTC2858-2 H-Grade | ● | | ± 10 | μA |
| I_{OSD} | Maximum Driver Short-Circuit Current | $-7\text{V} \leq (Y \text{ or } Z) \leq 12\text{V}$ (Figure 2) | ● | ± 120 | ± 250 | mA |
| Receiver | | | | | | |
| I_{IN} | Receiver Input Current (A, B) | $DE = TE = 0\text{V}$, $V_{CC} = 0\text{V}$ or 5V , $V_{IN} = 12\text{V}$ (Figure 3) (C, I-Grade) | ● | | 125 | μA |
| | | $DE = TE = 0\text{V}$, $V_{CC} = 0\text{V}$ or 5V , $V_{IN} = -7\text{V}$, (Figure 3) (C, I-Grade) | ● | -100 | μA | |
| | | $DE = TE = 0\text{V}$, $V_{CC} = 0\text{V}$ or 5V , $V_{IN} = 12\text{V}$ (Figure 3) (H-Grade) | ● | | 250 | μA |
| | | $DE = TE = 0\text{V}$, $V_{CC} = 0\text{V}$ or 5V , $V_{IN} = -7\text{V}$, (Figure 3) (H-Grade) | ● | -145 | μA | |
| R_{IN} | Receiver Input Resistance | $\overline{RE} = V_{CC}$ or 0V , $DE = TE = 0\text{V}$, $V_{IN} = -7\text{V}$, -3V , 3V , 7V , 12V (Figure 3) (C, I-Grade) | ● | 96 | 125 | $\text{k}\Omega$ |
| | | $\overline{RE} = V_{CC}$ or 0V , $DE = TE = 0\text{V}$, $V_{IN} = -7\text{V}$, -3V , 3V , 7V , 12V (Figure 3) (H-Grade) | ● | 48 | 125 | $\text{k}\Omega$ |
| V_{TH} | Receiver Differential Input Threshold Voltage | $-7\text{V} \leq B \leq 12\text{V}$ | ● | | ± 0.2 | V |
| ΔV_{TH} | Receiver Input Hysteresis | $B = 0\text{V}$ | | 25 | | mV |
| V_{OH} | Receiver Output High Voltage | $I(RO) = -4\text{mA}$, A-B = 200mV , $V_{CC} = 4.5\text{V}$ | ● | 2.4 | | V |
| V_{OL} | Receiver Output Low Voltage | $I(RO) = 4\text{mA}$, A-B = -200mV , $V_{CC} = 4.5\text{V}$ | ● | | 0.4 | V |
| I_{OZR} | Receiver Three-State (High Impedance) Output Current on RO | $\overline{RE} = 5\text{V}$, $0\text{V} \leq RO \leq V_{CC}$, LTC2856-1, LTC2856-2, LTC2858-1, LTC2858-2 | ● | | ± 1 | μA |
| Logic | | | | | | |
| V_{IH} | Logic Input High Voltage | DE, DI, \overline{RE} , $V_{CC} = 5.5\text{V}$ | ● | 2 | | V |
| V_{IL} | Logic Input Low Voltage | DE, DI, \overline{RE} , $V_{CC} = 4.5\text{V}$ | ● | | 0.8 | V |
| I_{INL} | Logic Input Current | DE, DI, \overline{RE} | ● | 0 | ± 10 | μA |
| Supplies | | | | | | |
| I_{CCS} | Supply Current in Shutdown Mode | $DE = 0\text{V}$, $\overline{RE} = V_{CC}$, LTC2856, LTC2858 (C and I-Grade) | ● | 0 | 5 | μA |
| | | LTC2856, LTC2858 (H-Grade) | ● | 0 | 15 | μA |
| I_{CCR} | Supply Current in Receive Mode | No Load, $DE = 0\text{V}$, $\overline{RE} = 0\text{V}$, LTC2856-1, LTC2856-2, LTC2858-1, LTC2858-2 | ● | 540 | 900 | μA |

SWITCHING CHARACTERISTICS The ● denotes the specifications which apply over the full operating temperature range, otherwise specifications are at $T_A = 25^\circ\text{C}$. $V_{CC} = 5\text{V}$ unless otherwise noted. (Note 2)

| SYMBOL | PARAMETER | CONDITIONS | MIN | TYP | MAX | UNITS | |
|-------------------|--|--|-------------------------------------|-----|------|---------------|---------------|
| I_{CCT} | Supply Current in Transmit Mode | No Load, $DE = V_{CC}$, $RE = V_{CC}$ | LTC2856-1 LTC2858-1 | ● | 630 | 1000 | μA |
| | | LTC2856-2 LTC2858-2 | ● | 670 | 1100 | μA | |
| I_{CCTR} | Supply Current with Both Driver and Receiver Enabled | No Load, $DE = V_{CC}$, $RE = 0\text{V}$ | LTC2856-1 LTC2857-1 LTC2858-1 | ● | 660 | 1100 | μA |
| | | LTC2856-2 LTC2857-2 LTC2858-2 | ● | 700 | 1200 | μA | |

Driver in LTC2856-1, LTC2857-1, LTC2858-1

| | | | | | | |
|---|---|---|---|----|---------|---------------|
| f_{MAX} | Maximum Data Rate | (Note 3) | ● | 20 | | Mbps |
| $t_{\text{PLHD}}, t_{\text{PHLD}}$ | Driver Input to Output | $R_{\text{DIFF}} = 54\Omega$, $C_L = 100\text{pF}$ (Figure 4) | ● | 10 | 50 | ns |
| Δt_{PD} | Driver Input to Output Difference $ t_{\text{PLHD}} - t_{\text{PHLD}} $ | $R_{\text{DIFF}} = 54\Omega$, $C_L = 100\text{pF}$ (Figure 4) | ● | 1 | 6 | ns |
| t_{SKEWD} | Driver Output Y to Output Z | $R_{\text{DIFF}} = 54\Omega$, $C_L = 100\text{pF}$ (Figure 4) | ● | 1 | ± 6 | ns |
| $t_{\text{RD}}, t_{\text{FD}}$ | Driver Rise or Fall Time | $R_{\text{DIFF}} = 54\Omega$, $C_L = 100\text{pF}$ (Figure 4) | ● | 4 | 12.5 | ns |
| $t_{\text{ZLD}}, t_{\text{ZHD}},$ $t_{\text{LZD}}, t_{\text{HZD}}$ | Driver Enable or Disable Time | $R_L = 500\Omega$, $C_L = 50\text{pF}$, $RE = 0\text{V}$, LTC2856-1, LTC2858-1 (Figure 5) | ● | | 70 | ns |
| $t_{\text{ZHSD}}, t_{\text{ZLSD}}$ | Driver Enable from Shutdown | $R_L = 500\Omega$, $C_L = 50\text{pF}$, $RE = V_{CC}$, LTC2856-1, LTC2858-1 (Figure 5) | ● | | 8 | μs |
| t_{SHDN} | Time to Shutdown | ($DE = \downarrow$, $RE = V_{CC}$) or ($DE = 0\text{V}$, $RE = \uparrow$), LTC2856-1, LTC2858-1 (Figure 5) | ● | | 100 | ns |

Driver in LTC2856-2, LTC2857-2, LTC2858-2

| | | | | | | |
|--------------------------------------|---|---|---|------|-----------|---------------|
| f_{MAXS} | Maximum Data Rate | (Note 3) | ● | 250 | | kbps |
| $t_{\text{PLHDS}}, t_{\text{PHLDS}}$ | Driver Input to Output | $R_{\text{DIFF}} = 54\Omega$, $C_L = 100\text{pF}$ (Figure 4) | ● | 0.95 | 1.5 | μs |
| Δt_{PDS} | Driver Input to Output Difference $ t_{\text{PLHD}} - t_{\text{PHLD}} $ | $R_{\text{DIFF}} = 54\Omega$, $C_L = 100\text{pF}$ (Figure 4) | ● | 50 | 500 | ns |
| t_{SKEWDS} | Driver Output A to Output B | $R_{\text{DIFF}} = 54\Omega$, $C_L = 100\text{pF}$ (Figure 4) | ● | 200 | ± 500 | ns |
| $t_{\text{RDS}}, t_{\text{FDS}}$ | Driver Rise or Fall Time | $R_{\text{DIFF}} = 54\Omega$, $C_L = 100\text{pF}$ (Figure 4) | ● | 0.90 | 1.5 | μs |
| $t_{\text{ZHDS}}, t_{\text{ZLDS}}$ | Driver Enable Time | $R_L = 500\Omega$, $C_L = 50\text{pF}$, $RE = 0\text{V}$, LTC2856-2, LTC2858-2 (Figure 5) | ● | | 300 | ns |
| $t_{\text{LZDS}}, t_{\text{HZDS}}$ | Driver Disable Time | $R_L = 500\Omega$, $C_L = 50\text{pF}$, $RE = 0\text{V}$, LTC2856-2, LTC2858-2 (Figure 5) | ● | | 70 | ns |
| $t_{\text{ZHSDS}}, t_{\text{ZLSDS}}$ | Driver Enable from Shutdown | $R_L = 500\Omega$, $C_L = 50\text{pF}$, $RE = V_{CC}$, LTC2856-2, LTC2858-2 (Figure 5) | ● | | 8 | μs |
| t_{SHDNS} | Time to Shutdown | ($DE = 0\text{V}$, $RE = \uparrow$) or ($DE = \downarrow$, $RE = V_{CC}$), LTC2856-2, LTC2858-2 (Figure 5) | ● | | 500 | ns |

Receiver

| | | | | | | |
|---|---|--|---|----|------|---------------|
| $t_{\text{PLHR}}, t_{\text{PHLR}}$ | Receiver Input to Output | $C_L = 15\text{pF}$, $V_{\text{CM}} = 1.5\text{V}$, $ V_{\text{AB}} = 1.5\text{V}$, t_{R} and $t_{\text{F}} < 4\text{ns}$ (Figure 6) | ● | 50 | 70 | ns |
| t_{SKEWR} | Differential Receiver Skew, $ t_{\text{PLHR}} - t_{\text{PHLR}} $ | $C_L = 15\text{pF}$ (Figure 6) | ● | 1 | 6 | ns |
| $t_{\text{RR}}, t_{\text{FR}}$ | Receiver Output Rise or Fall Time | $C_L = 15\text{pF}$ (Figure 6) | ● | 3 | 12.5 | ns |
| $t_{\text{ZLR}}, t_{\text{ZHR}},$ $t_{\text{LZR}}, t_{\text{HZR}}$ | Receiver Enable/Disable | $R_L = 1\text{k}$, $C_L = 15\text{pF}$, $DE = V_{CC}$, LTC2856-1, LTC2856-2, LTC2858-1, LTC2858-2 (Figure 7) | ● | | 50 | ns |
| $t_{\text{ZHSR}}, t_{\text{ZLSR}}$ | Receiver Enable from Shutdown | $R_L = 1\text{k}$, $C_L = 15\text{pF}$, $DE = 0\text{V}$, LTC2856-1, LTC2856-2, LTC2858-1, LTC2858-2 (Figure 7) | ● | | 8 | μs |

ELECTRICAL CHARACTERISTICS

Note 1: Stresses beyond those listed under Absolute Maximum Ratings may cause permanent damage to the device. Exposure to any Absolute Maximum Rating condition for extended periods may affect device reliability and lifetime. High temperatures degrade operating lifetimes. Operating lifetime is derated at temperatures greater than 105°C.

Note 2: All currents into device pins are positive; all currents out of device pins are negative. All voltages are referenced to device ground unless otherwise specified.

Note 3: Maximum data rate is guaranteed by other measured parameters and is not tested directly.

Note 4: This IC includes overtemperature protection that is intended to protect the device during momentary overload conditions. Overtemperature protection activates at a junction temperature exceeding 150°C. Continuous operation above the specified maximum operating junction temperature may result in device degradation or failure.

TEST CIRCUITS

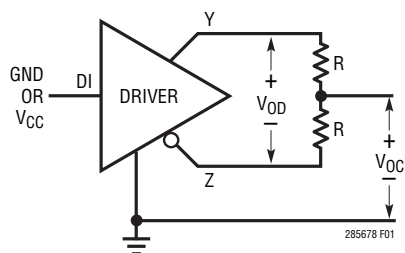

Figure 1. Driver DC Characteristics

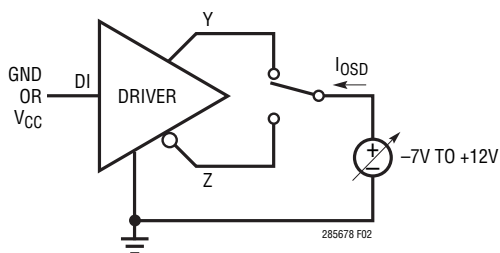

Figure 2. Driver Output Short-Circuit Current

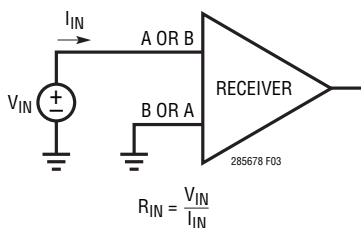

Figure 3. Receiver Input Current and Input Resistance

TEST CIRCUITS

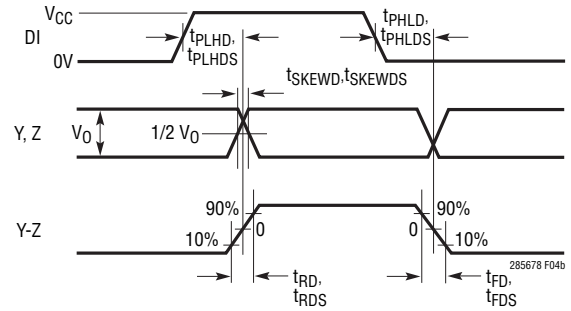
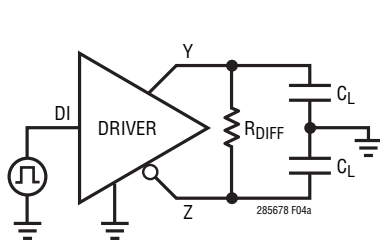

Figure 4. Driver Timing Measurement

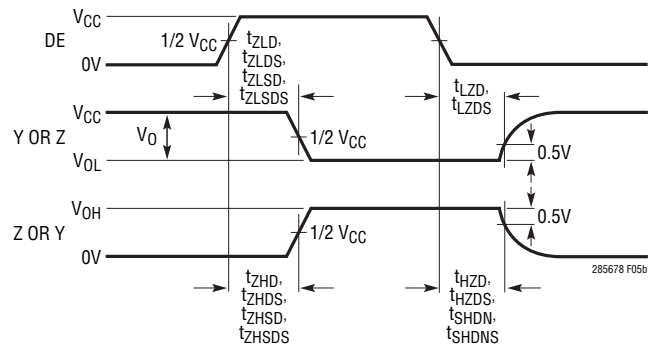
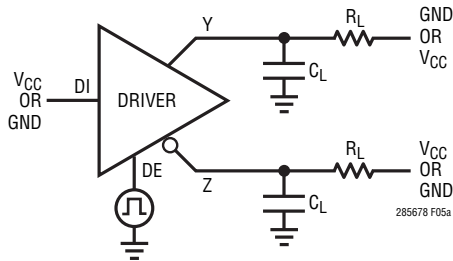

Figure 5. Driver Enable and Disable Timing Measurement

TEST CIRCUITS

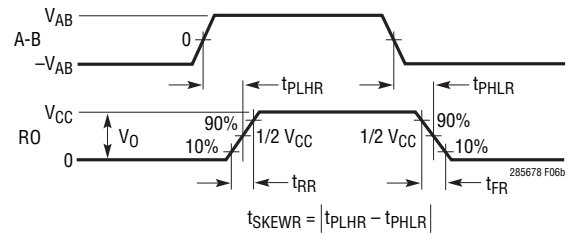
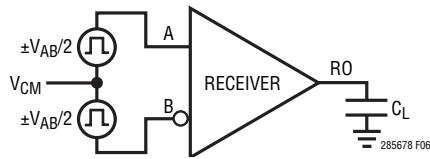

Figure 6. Receiver Propagation Delay Measurements

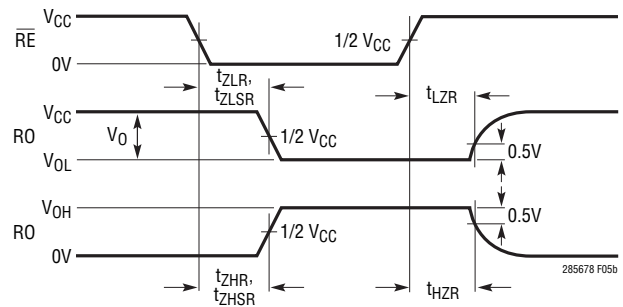
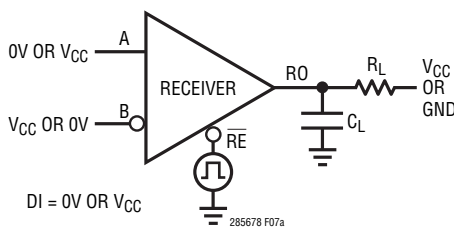

Figure 7. Receiver Enable/Disable Time Measurements

FUNCTION TABLES

LTC2856-1, LTC2856-2

| LOGIC INPUTS | | MODE | A, B | RO |
|--------------|----|------------|-----------------|--------|
| DE | RE | | | |
| 0 | 0 | Receive | R _{IN} | Driven |
| 0 | 1 | Shutdown | R _{IN} | High-Z |
| 1 | 0 | Transceive | Driven | Driven |
| 1 | 1 | Transmit | Driven | High-Z |

LTC2858-1, LTC2858-2

| LOGIC INPUTS | | MODE | A, B | Y, Z | RO |
|--------------|----|------------|-----------------|--------|--------|
| DE | RE | | | | |
| 0 | 0 | Receive | R _{IN} | High-Z | Driven |
| 0 | 1 | Shutdown | R _{IN} | High-Z | High-Z |
| 1 | 0 | Transceive | R _{IN} | Driven | Driven |
| 1 | 1 | Transmit | R _{IN} | Driven | High-Z |

TYPICAL PERFORMANCE CHARACTERISTICS $T_A = 25^\circ\text{C}$, $V_{CC} = 5\text{V}$ unless otherwise noted.

Receiver Skew vs Temperature

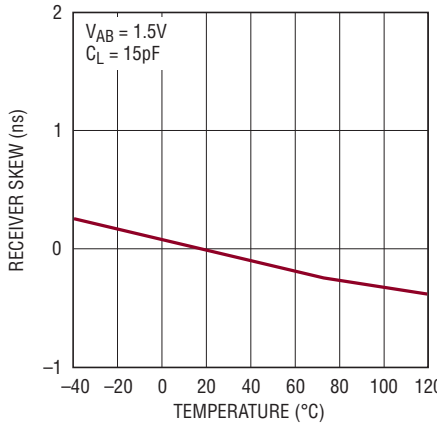

385678 G01

Driver Skew vs Temperature

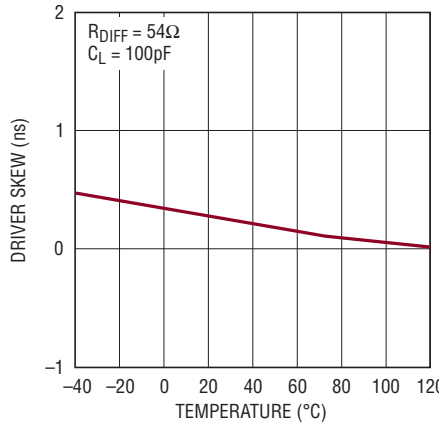

385678 G02

Driver Propagation Delay vs Temperature

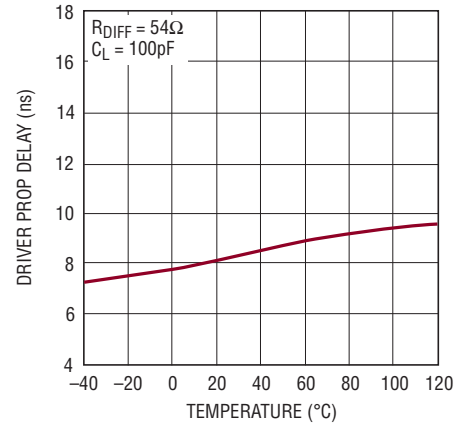

285678 G03

Driver Output Short-Circuit Current vs Temperature

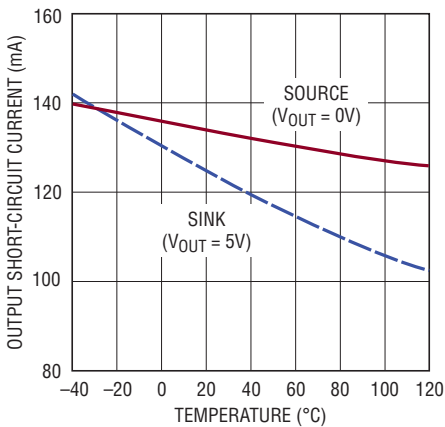

285678 G04

Driver Output Low/High Voltage vs Output Current

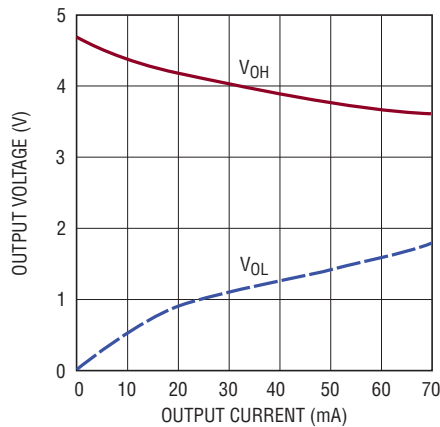

285678 G05

Driver Differential Output Voltage vs Temperature

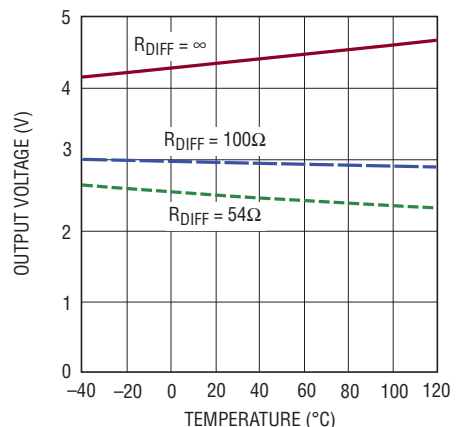

285678 G06

Receiver Output Voltage vs Output Current (Source and Sink)

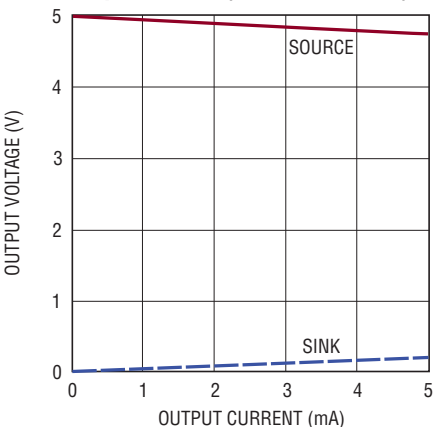

285678 G07

Receiver Propagation Delay vs Temperature

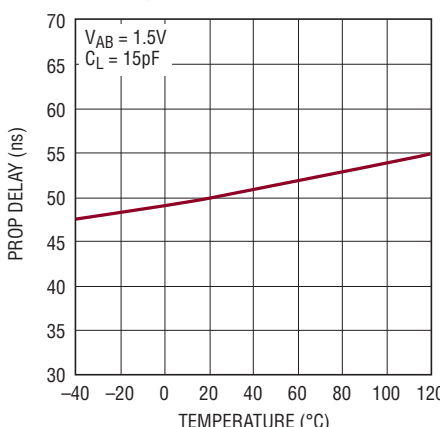

285678 G08

Supply Current vs Data Rate

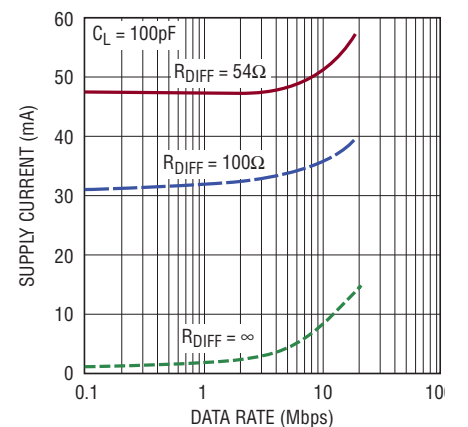

285678 G09

PIN FUNCTIONS

| PIN NAME | PIN NUMBER | | | DESCRIPTION |
|-----------------|------------------------|------------------------|------------------------|---|
| | LTC2856-1 LTC2856-2 | LTC2857-1 LTC2857-2 | LTC2858-1 LTC2858-2 | |
| RO | 1 | 2 | 1 | Receiver Output. If the receiver output is enabled (\overline{RE} low) and $A > B$ by 200mV, then RO will be high. If $A < B$ by 200mV, then RO will be low. If the receiver inputs are open, shorted or terminated without a valid signal, RO will be high. |
| \overline{RE} | 2 | | 2 | Receiver Enable. A low enables the receiver. A high input forces the receiver output into a high impedance state. |
| DE | 3 | | 3 | Driver Enable. A high on DE enables the driver. A low input will force the driver outputs into a high impedance. If \overline{RE} is high with DE low, the part will enter a low power shutdown state. |
| DI | 4 | 3 | 4 | Driver Input. If the driver outputs are enabled (DE high), then a low on DI forces the driver positive output low and negative output high. A high on DI, with the driver outputs enabled, forces the driver positive output high and negative output low. |
| GND | 5/9* | 4/9* | 5/11* | Ground. *The Exposed Pad on the DFN packages should be connected to ground. |
| Y | | 5 | 6 | Noninverting Driver Output for the LTC2857-1, LTC2857-2, LTC2858-1 and LTC2858-2. High impedance when the driver is disabled (LTC2858-1) or unpowered. |
| Z | | 6 | 7 | Inverting Driver Output for the LTC2857-1, LTC2857-2, LTC2858-1 and LTC2858-2. High impedance when the driver is disabled (LTC2858-1) or unpowered. |
| B | 7 | 7 | 8 | Inverting Receiver Input (and Inverting Driver Output for the LTC2856-1 and LTC2856-2). Impedance is $> 96k\Omega$ in receive mode or unpowered. |
| A | 6 | 8 | 9 | Noninverting Receiver Input (and Noninverting Driver Output for the LTC2856-1 and LTC2856-2). Impedance is $> 96k\Omega$ in receive mode or unpowered. |
| V _{CC} | 8 | 1 | 10 | Positive Supply. $4.5V < V_{CC} < 5.5V$. Bypass with a 0.1 μ F ceramic capacitor. |

BLOCK DIAGRAMS

LTC2856-1, LTC2856-2

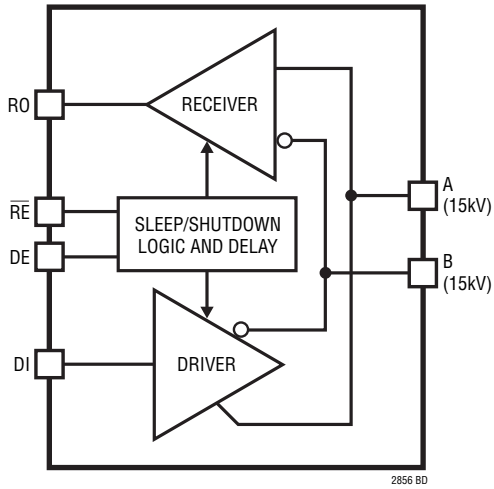

LTC2857-1, LTC2857-2

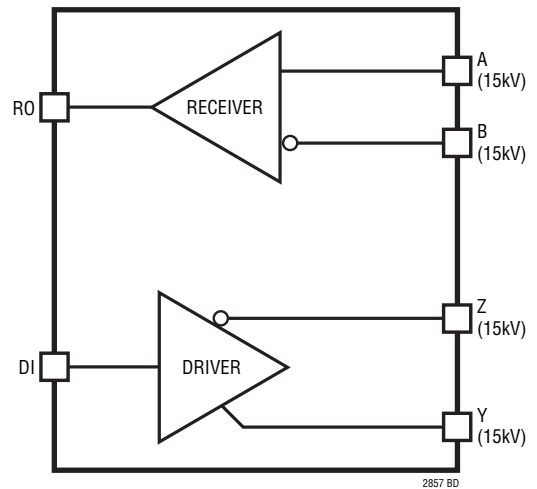

LTC2858-1, LTC2858-2

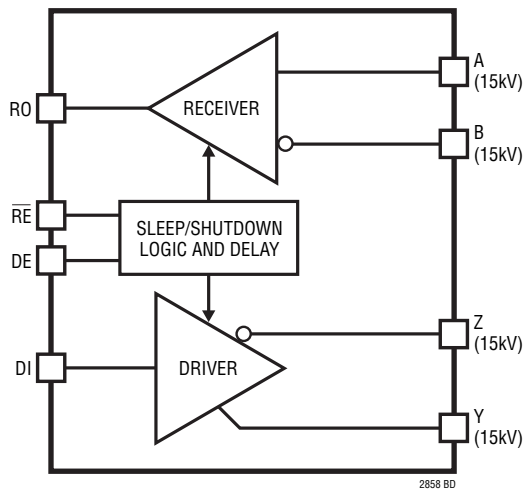

APPLICATIONS INFORMATION

Driver

The driver provides full RS485 and RS422 compatibility. When enabled, if DI is high, Y-Z is positive for the full-duplex devices and A-B is positive for the half-duplex device.

When the driver is disabled, both outputs are high impedance. For the full-duplex devices, the leakage on the driver output pins is guaranteed to be less than $10\mu\text{A}$ over the entire common mode range of -7V to 12V . On the half-duplex device, the impedance is dominated by the receiver input resistance, R_{IN} .

Driver Overvoltage and Overcurrent Protection

The driver outputs are protected from short circuits to any voltage within the Absolute Maximum range of $(V_{\text{CC}} - 15\text{V})$ to 15V . The maximum current in this condition is 250mA . If the pin voltage exceeds about $\pm 10\text{V}$, current limit folds back to about half of the peak value to reduce overall power dissipation and avoid damaging the part.

All devices also feature thermal shutdown protection that disables the driver and receiver output in case of excessive power dissipation (see Note 4).

Slew Limiting for EMI Emissions Control

The LTC2856-2, LTC2857-2 and the LTC2858-2 feature reduced slew rate driver outputs to control the high frequency EMI emissions from equipment and data cables. These devices are limited to data rates of 250kbaud or less. Slew limiting also mitigates the adverse affects of imperfect transmission line termination caused by stubs or mismatched cable.

Figures 10 and 11 show the output waveforms from the LTC2858-1 and its slew rate limited counterpart, the LTC2858-2, operating at 250kbaud . The corresponding frequency spectrums show significant reduction in the high frequency harmonics for the slew rate limited device.

Receiver and Failsafe

With the receiver enabled, when the absolute value of the differential voltage between the A and B pins is greater

than 200mV , the state of RO will reflect the polarity of (A-B).

These parts have a failsafe feature that guarantees the receiver output to be in a logic-high state when the inputs are either shorted, left open or terminated, but not driven for more than about $3\mu\text{s}$. The delay prevents signal zero crossings from being interpreted as shorted inputs and causing RO to go high inadvertently. This failsafe feature is guaranteed to work for inputs spanning the entire common mode range of -7V to 12V .

The receiver output is internally driven high (to V_{CC}) or low (to ground) with no external pull-up needed. When the receiver is disabled the RO pin becomes high-Z with leakage of less than $\pm 1\mu\text{A}$ for voltages within the supply range.

Receiver Input Resistance

The receiver input resistance from A or B to ground is guaranteed to be greater than 96k (C, I-Grade). This is $8\times$ higher than the requirements for the RS485 standard and thus this receiver represents a one-eighth unit load. This, in turn, means that $8\times$ the standard number of receivers, or 256 total, can be connected to a line without loading it beyond what is called out in the RS485 standard. The receiver input resistance from A or B to ground on high temperature H-Grade parts is greater than 48k providing a one-quarter unit load. The input resistance of the receivers is unaffected by enabling/disabling the receiver and by powering/unpowering the part.

Supply Current

The unloaded static supply currents in these devices are very low—typically under $700\mu\text{A}$ for all modes of operation. In applications with resistively terminated cables, the supply current is dominated by the driver load. For example, when using two 120Ω terminators with a differential driver output voltage of 2V , the DC load current is 33mA , which is sourced by the positive voltage supply. Power supply current increases with toggling data due to capacitive loading and this term can increase significantly at high data rates. Figure 8 shows supply current vs data rate for two different capacitive loads for the circuit configuration of Figure 4.

APPLICATIONS INFORMATION

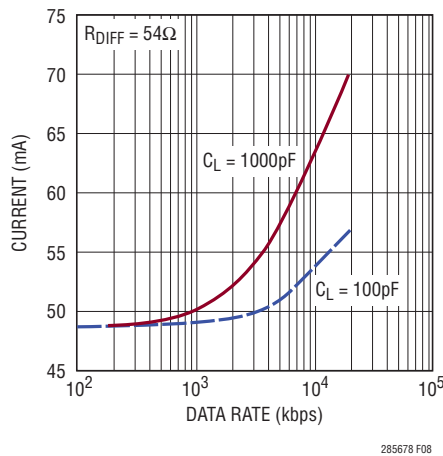

Figure 8. Supply Current vs Data Rate

High Speed Considerations

A ground plane layout is recommended. A 0.1 μ F bypass capacitor less than one-quarter inch away from the V_{CC} pin is also recommended. The PC board traces connected to signals A/B and Z/Y should be symmetrical and as short as possible to maintain good differential signal integrity. To minimize capacitive effects, the differential signals should be separated by more than the width of a trace and should not be routed on top of each other if they are on different signal planes.

Care should be taken to route outputs away from any sensitive inputs to reduce feedback effects that might cause noise, jitter or even oscillations. For example, in the full-duplex LTC2857-1, DI and A/B should not be routed near the driver or receiver outputs.

The logic inputs have 100mV of hysteresis to provide noise immunity. Fast edges on the outputs can cause glitches in the ground and power supplies which are exacerbated by capacitive loading. If a logic input is held near its threshold (typically 1.5V), a noise glitch from a driver transition may exceed the hysteresis levels on the logic and data input pins causing an unintended state change. This can be avoided by maintaining normal logic levels on the pins and by slewing inputs through their thresholds by faster than 1V/ μ s when transitioning. Good supply decoupling and proper line termination also reduce glitches caused by driver transitions.

Cable Length vs Data Rate

For a given data rate, the maximum transmission distance is bounded by the cable properties. A typical curve of cable length vs data rate compliant with the RS485 standard is shown in Figure 9. Three regions of this curve reflect different performance limiting factors in data transmission. In the flat region of the curve, maximum distance is determined by resistive losses in the cable. The downward sloping region represents limits in distance and data rate due to AC losses in the cable. The solid vertical line represents the specified maximum data rate in the RS485 standard. The dashed line at 250kbps shows the maximum data rate of the low-EMI LTC2856-2, LTC2857-2, and LTC2858-2. The dashed line at 20Mbps shows the maximum data rates of the LTC2856-1, LTC2857-1 and LTC2858-1.

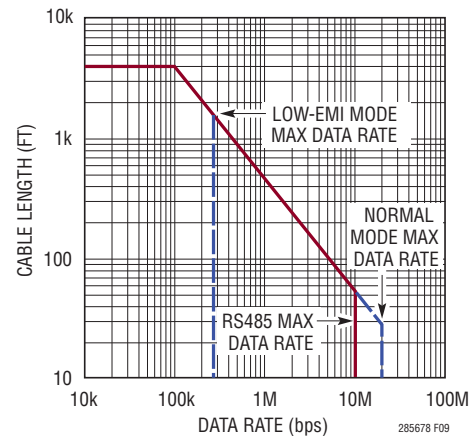

Figure 9. Cable Length vs Data Rate (RS485 Standard Shown in Solid Vertical Lines)

Cable Termination

Proper cable termination is very important for good signal fidelity. If the cable is not terminated with its characteristic impedance, reflections will result in distorted waveforms.

RS485 transceivers typically communicate over twisted-pair cables with characteristic impedance ranging from 100 Ω to 120 Ω . Each end of the network should be terminated with a discrete resistor matching the characteristic impedance or with an LTC2859/LTC2861 transceiver with integrated termination capability.

APPLICATIONS INFORMATION

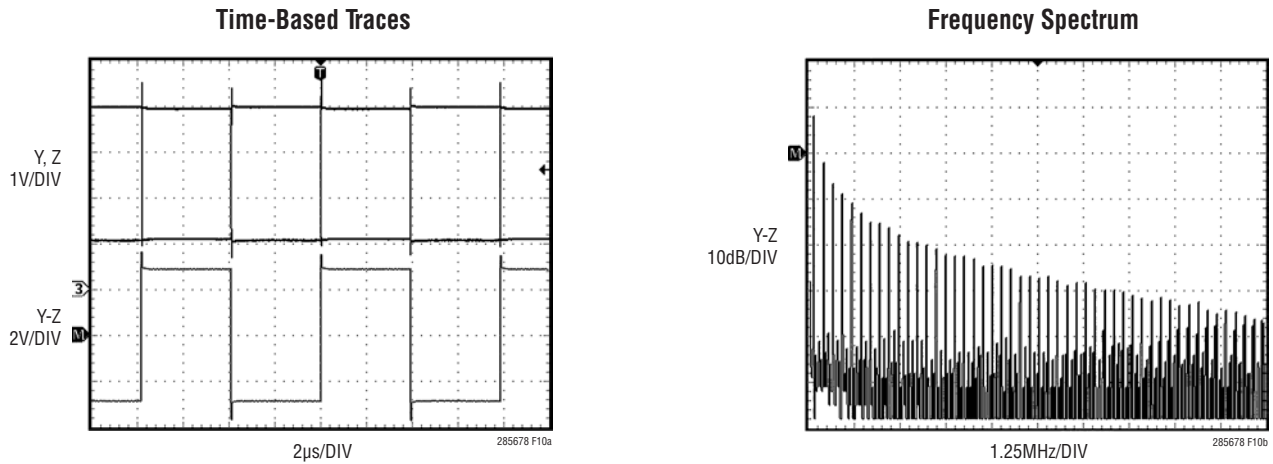

Figure 10. LTC2858-1 Driver Output at 100kHz Into 100Ω Resistor

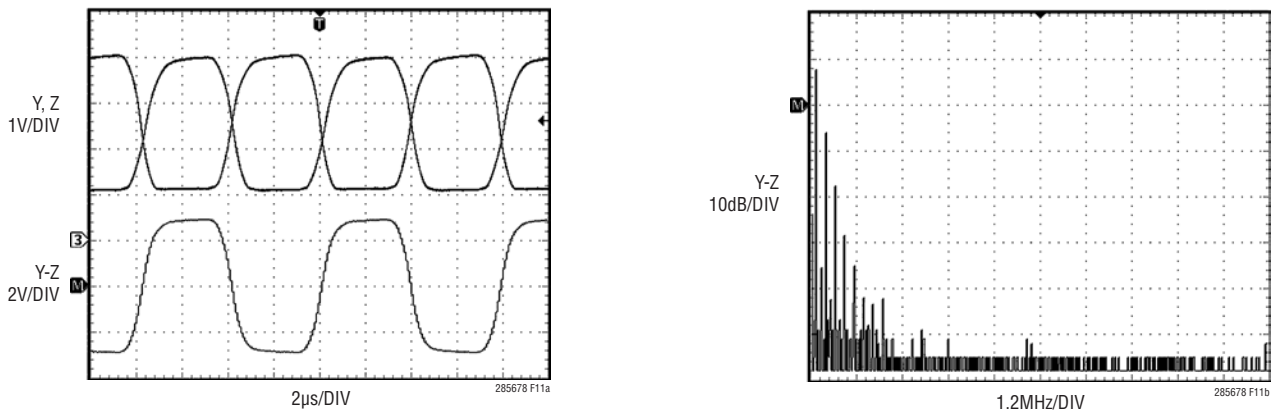
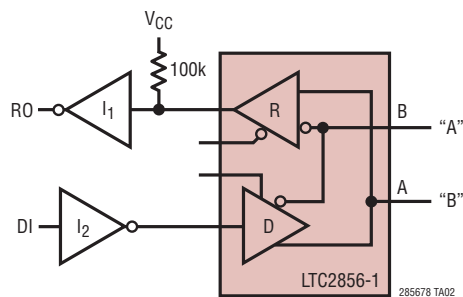

Figure 11. LTC2858-2 Driver Output at 100kHz Into 100Ω Resistor

TYPICAL APPLICATIONS

Failsafe “0” Application (Idle State = Logic “0”)



285678fg

PACKAGE DESCRIPTION

Please refer to <http://www.linear.com/product/LTC2856-1#packaging> for the most recent package drawings.

DD Package
8-Lead Plastic DFN (3mm × 3mm)
 (Reference LTC DWG # 05-08-1698 Rev C)

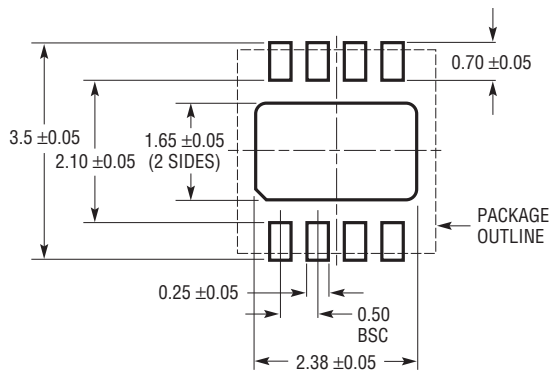

RECOMMENDED SOLDER PAD PITCH AND DIMENSIONS
 APPLY SOLDER MASK TO AREAS THAT ARE NOT SOLDERED

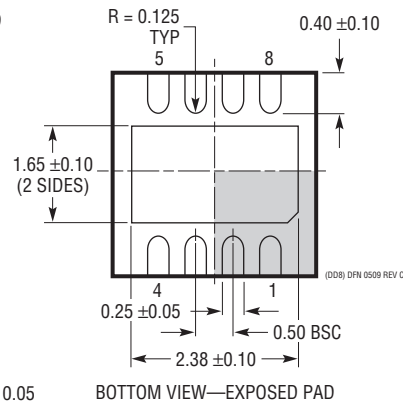
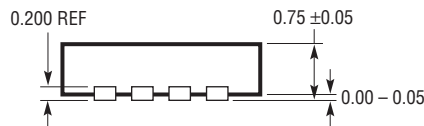
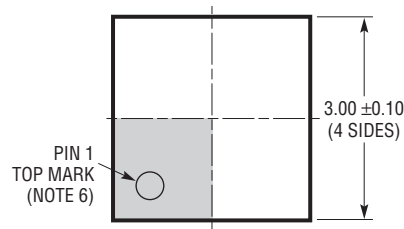

NOTE:

1. DRAWING TO BE MADE A JEDEC PACKAGE OUTLINE M0-229 VARIATION OF (WEED-1)
2. DRAWING NOT TO SCALE
3. ALL DIMENSIONS ARE IN MILLIMETERS
4. DIMENSIONS OF EXPOSED PAD ON BOTTOM OF PACKAGE DO NOT INCLUDE MOLD FLASH. MOLD FLASH, IF PRESENT, SHALL NOT EXCEED 0.15mm ON ANY SIDE
5. EXPOSED PAD SHALL BE SOLDER PLATED
6. SHADED AREA IS ONLY A REFERENCE FOR PIN 1 LOCATION ON TOP AND BOTTOM OF PACKAGE

PACKAGE DESCRIPTION

Please refer to <http://www.linear.com/product/LTC2856-1#packaging> for the most recent package drawings.

DD Package
10-Lead Plastic DFN (3mm × 3mm)
 (Reference LTC DWG # 05-08-1699 Rev C)

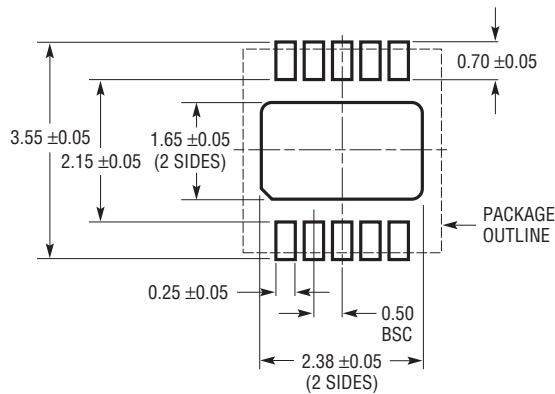

RECOMMENDED SOLDER PAD PITCH AND DIMENSIONS

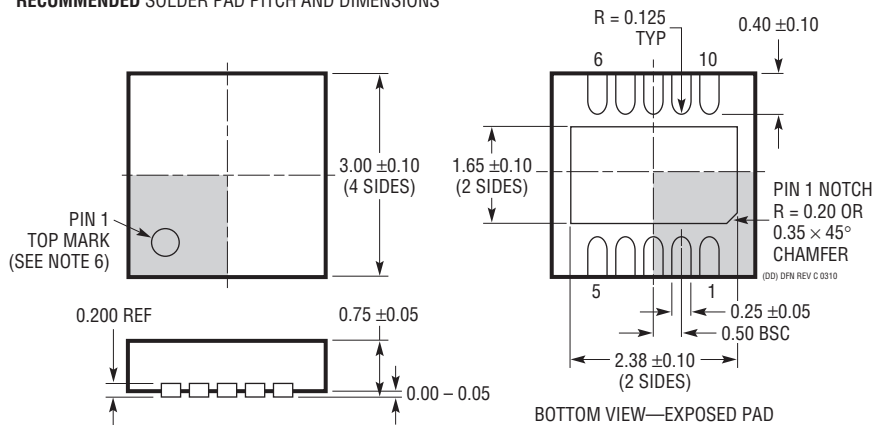

NOTE:

1. DRAWING TO BE MADE A JEDEC PACKAGE OUTLINE M0-229 VARIATION OF (WEED-2). CHECK THE LTC WEBSITE DATA SHEET FOR CURRENT STATUS OF VARIATION ASSIGNMENT
2. DRAWING NOT TO SCALE
3. ALL DIMENSIONS ARE IN MILLIMETERS
4. DIMENSIONS OF EXPOSED PAD ON BOTTOM OF PACKAGE DO NOT INCLUDE MOLD FLASH. MOLD FLASH, IF PRESENT, SHALL NOT EXCEED 0.15mm ON ANY SIDE
5. EXPOSED PAD SHALL BE SOLDER PLATED
6. SHADED AREA IS ONLY A REFERENCE FOR PIN 1 LOCATION ON THE TOP AND BOTTOM OF PACKAGE

PACKAGE DESCRIPTION

Please refer to <http://www.linear.com/product/LTC2856-1#packaging> for the most recent package drawings.

MS8 Package 8-Lead Plastic MSOP

(Reference LTC DWG # 05-08-1660 Rev G)

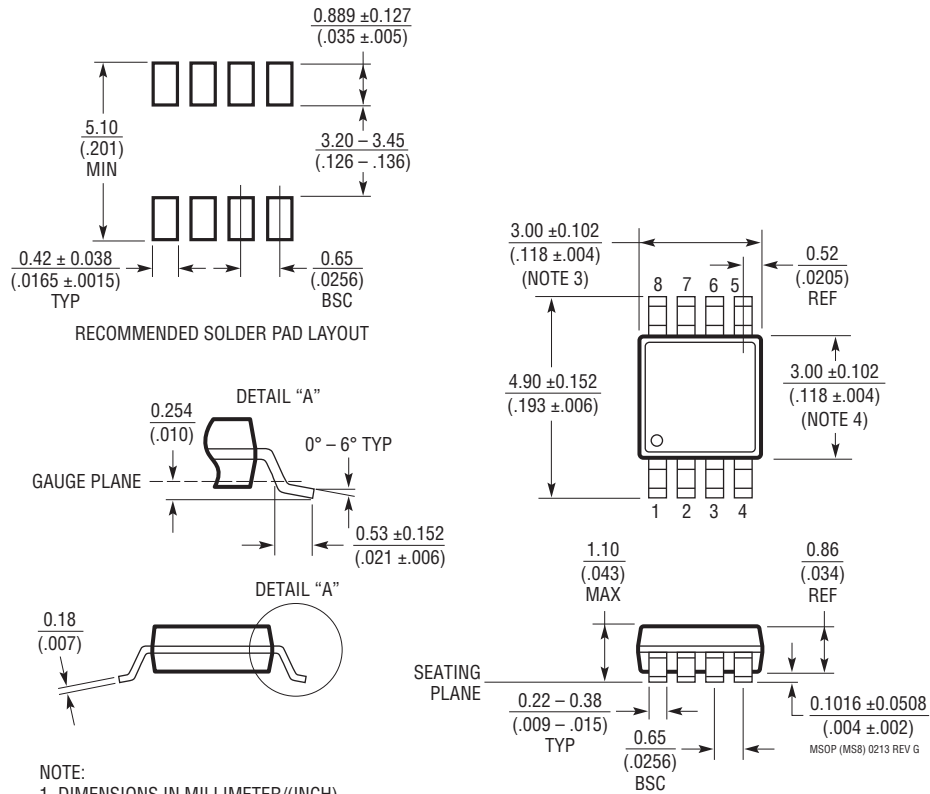

NOTE:

1. DIMENSIONS IN MILLIMETER/(INCH)
2. DRAWING NOT TO SCALE
3. DIMENSION DOES NOT INCLUDE MOLD FLASH, PROTRUSIONS OR GATE BURRS.
MOLD FLASH, PROTRUSIONS OR GATE BURRS SHALL NOT EXCEED 0.152mm (.006") PER SIDE
4. DIMENSION DOES NOT INCLUDE INTERLEAD FLASH OR PROTRUSIONS.
INTERLEAD FLASH OR PROTRUSIONS SHALL NOT EXCEED 0.152mm (.006") PER SIDE
5. LEAD COPLANARITY (BOTTOM OF LEADS AFTER FORMING) SHALL BE 0.102mm (.004") MAX

LTC2856-1/LTC2856-2
 LTC2857-1/LTC2857-2
 LTC2858-1/LTC2858-2

PACKAGE DESCRIPTION

Please refer to <http://www.linear.com/product/LTC2856-1#packaging> for the most recent package drawings.

MS Package 10-Lead Plastic MSOP

(Reference LTC DWG # 05-08-1661 Rev F)

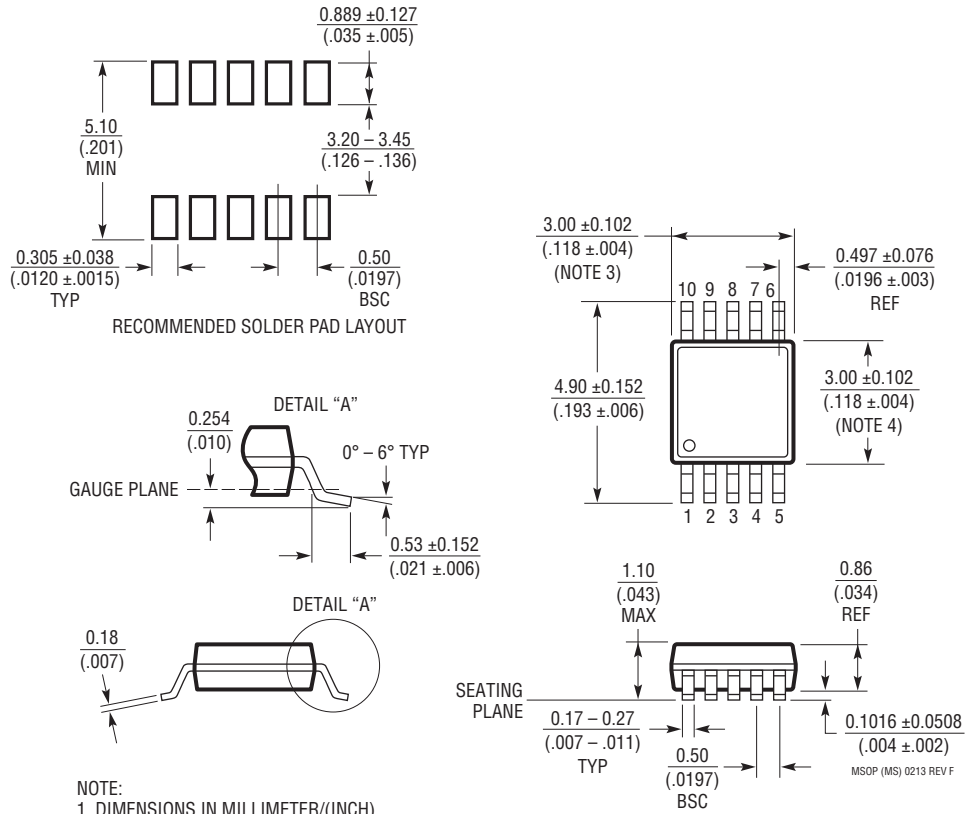

NOTE:

1. DIMENSIONS IN MILLIMETER/(INCH)
2. DRAWING NOT TO SCALE
3. DIMENSION DOES NOT INCLUDE MOLD FLASH, PROTRUSIONS OR GATE BURRS.
MOLD FLASH, PROTRUSIONS OR GATE BURRS SHALL NOT EXCEED 0.152mm (.006") PER SIDE
4. DIMENSION DOES NOT INCLUDE INTERLEAD FLASH OR PROTRUSIONS.
INTERLEAD FLASH OR PROTRUSIONS SHALL NOT EXCEED 0.152mm (.006") PER SIDE
5. LEAD COPLANARITY (BOTTOM OF LEADS AFTER FORMING) SHALL BE 0.102mm (.004") MAX

MSOP (MS) 0213 REV F

REVISION HISTORY (Revision history begins at Rev F)

| REV | DATE | DESCRIPTION | PAGE NUMBER |
|-----|-------|---|-------------|
| F | 11/13 | Corrected θ_{JA} and θ_{JC} values. | 2 |
| G | 09/17 | Added H-Grade test condition for I_{OZD} | 4 |

TYPICAL APPLICATION

Multi-Node Network and End Termination Using the LTC2856-1

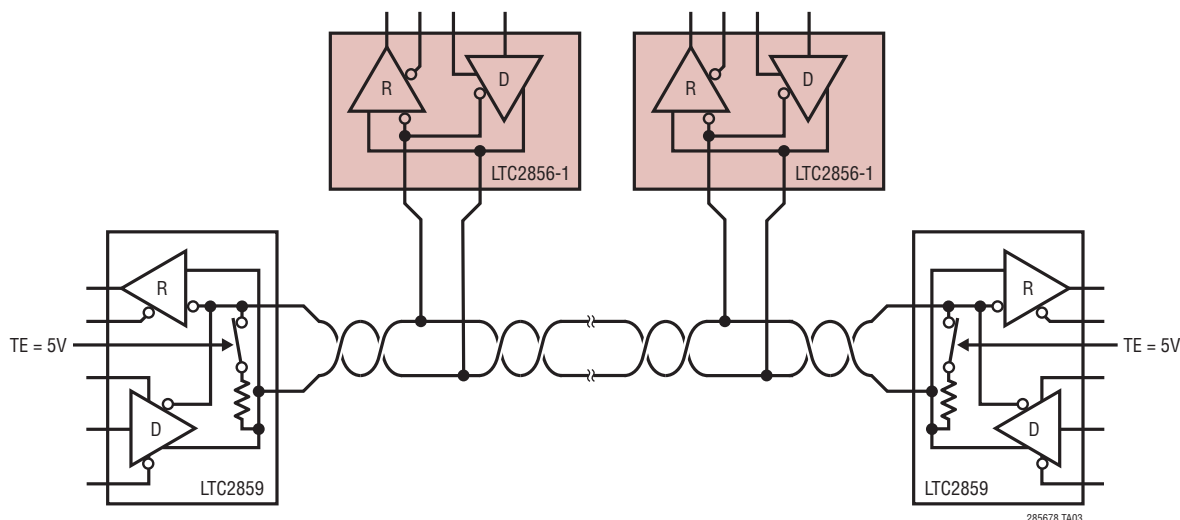

RELATED PARTS

| PART NUMBER | DESCRIPTION | COMMENTS |
|---------------------------------|--|---|
| LTC485 | Low Power RS485 Interface Transceiver | $I_{CC} = 300\mu\text{A}$ (Typ) |
| LTC491 | Differential RS485 Driver and Receiver Pair | $I_{CC} = 300\mu\text{A}$ |
| LTC1480 | 3.3V Ultralow Power RS485 Transceiver | 3.3V Operation |
| LTC1483 | Ultralow Power RS485 Low EMI Transceiver | Controlled Driver Slew Rate |
| LTC1485 | Differential Bus Transceiver | 10Mbaud Operation |
| LTC1487 | Ultralow Power RS485 with Low EMI, Shutdown and High Input Impedance | Up to 256 Transceiver on the Bus |
| LTC1520 | 50Mbps Precision Quad Line Receiver | Channel-to-Channel Skew 400ps (Typ) |
| LTC1535 | Isolated RS485 Full-Duplex Transceiver | 2500V _{RMS} Isolation in Surface Mount Package |
| LTC1685 | 52Mbps RS485 Transceiver with Precision Delay | Propagation Delay Skew 500ps (Typ) |
| LT1785 | 60V Fault Protected RS485 Transceiver | 60V Tolerant, $\pm 15\text{kV}$ ESD |
| LTC2859/LTC2861 | 20Mbps RS485 Transceivers with Integrated Switchable Termination | Integrated, Switchable, 120Ω Termination Resistor, $\pm 15\text{kV}$ ESD |

Mouser Electronics

Authorized Distributor

Click to View Pricing, Inventory, Delivery & Lifecycle Information:

[Analog Devices Inc.:](#)

[LTC2858HDD-1#TRPBF](#) [LTC2856CMS8-2#TRPBF](#) [LTC2858IMS-2#PBF](#) [LTC2857IMS8-2#TRPBF](#) [LTC2856IDD-1#TRPBF](#) [LTC2858CMS-1#TRPBF](#) [LTC2856CMS8-1#PBF](#) [LTC2858IDD-2#TRPBF](#) [LTC2857CMS8-2#PBF](#) [LTC2857CDD-2#TRPBF](#) [LTC2856CDD-1#PBF](#) [LTC2856IMS8-1#PBF](#) [LTC2857HMS8-1#TRPBF](#) [LTC2858HMS-2#TRPBF](#) [LTC2856HDD-2#PBF](#) [LTC2858HMS-1#PBF](#) [LTC2857IDD-1#PBF](#) [LTC2857CMS8-1#PBF](#) [LTC2856IDD-2#PBF](#) [LTC2856HDD-1#PBF](#) [LTC2858CDD-2#TRPBF](#) [LTC2858IMS-2#TRPBF](#) [LTC2857HMS8-2#PBF](#) [LTC2858HMS-1#TRPBF](#) [LTC2856HDD-2#TRPBF](#) [LTC2857IDD-1#TRPBF](#) [LTC2858CMS-2#PBF](#) [LTC2856CDD-1#TRPBF](#) [LTC2858IDD-1#PBF](#) [LTC2857HDD-1#PBF](#) [LTC2857CDD-1#PBF](#) [LTC2856HMS8-2#PBF](#) [LTC2856IMS8-2#PBF](#) [LTC2858IDD-1#TRPBF](#) [LTC2857IDD-2#PBF](#) [LTC2858HMS-2#PBF](#) [LTC2858IMS-1#PBF](#) [LTC2858CMS-2#TRPBF](#) [LTC2857CDD-1#TRPBF](#) [LTC2856HMS8-2#TRPBF](#) [LTC2857IMS8-1#TRPBF](#) [LTC2857IDD-2#TRPBF](#) [LTC2856HMS8-1#TRPBF](#) [LTC2856CDD-2#TRPBF](#) [LTC2858IDD-2#PBF](#) [LTC2857IMS8-2#PBF](#) [LTC2856HDD-1#TRPBF](#) [LTC2858HDD-1#PBF](#) [LTC2856IMS8-2#TRPBF](#) [LTC2857HMS8-1#PBF](#) [LTC2857HDD-2#TRPBF](#) [LTC2858CDD-1#PBF](#) [LTC2857HMS8-2#TRPBF](#) [LTC2856IDD-2#TRPBF](#) [LTC2858IMS-1#TRPBF](#) [LTC2856CMS8-2#PBF](#) [LTC2857HDD-1#TRPBF](#) [LTC2858HDD-2#TRPBF](#) [LTC2856IDD-1#PBF](#) [LTC2857CMS8-2#TRPBF](#) [LTC2857IMS8-1#PBF](#) [LTC2858CMS-1#PBF](#) [LTC2856HMS8-1#PBF](#) [LTC2858CDD-1#TRPBF](#) [LTC2858CDD-2#PBF](#) [LTC2857HDD-2#PBF](#) [LTC2856IMS8-1#TRPBF](#) [LTC2856CDD-2#PBF](#) [LTC2856CMS8-1#TRPBF](#) [LTC2858HDD-2#PBF](#) [LTC2857CDD-2#PBF](#) [LTC2857CMS8-1#TRPBF](#)