

Power Relay RM 5/6/B 3mm

- 2 and 3 pole 10/16A, 2 form A (2 NO) or 3 form A (3 NO) contacts
- 3mm contact gap
- DC or AC coil
- Push-to-test button
- Plug-in version, PCB terminals, chassis or DIN rail mount

Typical applications
Power supplies, pump control.



Approvals

VDE Cert. No. 40003144, UL E214025 (for RMB in preparation)
Technical data of approved types on request.

Contact Data	RM5	RM6	RMB
Contact arrangement	2 form A 2 NO	3 form A 3 NO	3 form A 3 NO
Contact gap	3mm	3mm	3mm
Rated voltage	400VAC	230VAC	230VAC
Max. switching voltage	440VAC	400VAC	400VAC
Rated current	16A	10A	16A
Limiting making current, max 20ms	30A	25A	30A
Switching power	6000VA	3800VA	6000VA
Contact material	AgCdO, AgNi90/10 for RM5 (VDE for RM6 and RMB in preparation)		
Min. recommended contact load	24VDC/100mA		
Frequency of operation, with/without load	960/6000h ⁻¹		
Operate/release time max., DC coil	20/5ms		
Bounce time max., form A, DC coil	4ms		

Contact ratings

Type	Contact	Load	Cycles
IEC 61810			
RM5	A (NO)	16A, 230/400VAC, cosφ=1, 35°C	100x10 ³
RM5	A (NO)	10A, 48VDC, 70°C	30x10 ³
RM5	A (NO)	10A, 400VAC, 70°C	30x10 ³
RM60	A (NO)	10A, 230/400VAC, cosφ=1, 35°C	100x10 ³
RMB0	A (NO)	16A, 400VAC same polarity, cosφ=1, 50°C	100x10 ³
UL 508			
RM5	A (NO)	16A, 415VAC, resistive, 50°C	100x10 ³
RM5	A (NO)	16A, 277VAC, general purpose, 50°C	30x10 ³
RM6	A (NO)	10A, 415VAC, resistive, DC-coil, 70°C	100x10 ³
RM6	A (NO)	10A, 415VAC, resistive, AC-coil, 50°C	100x10 ³
RM6	A (NO)	10A, 277VAC, gen. purp., DC-coil, 70°C	30x10 ³
RM6	A (NO)	10A, 277VAC, gen. purp., AC-coil, 50°C	30x10 ³
RMB	A (NO)	16A, 277VAC, general purpose, 25°C	30x10 ³

Mechanical endurance

DC coil 20x10⁶ operations
AC coil 20x10⁶ operations

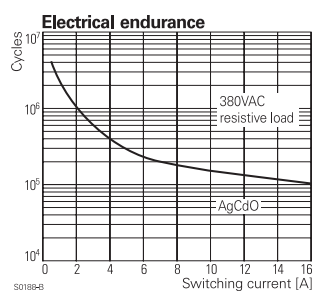
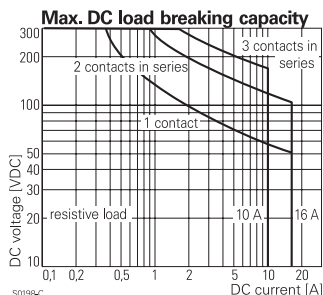

Coil Data

Coil voltage range	6 to 220 VDC 6 to 400 VAC
Operative range, IEC 61810	90 to 100% of rated coil voltage
Coil insulation system according UL	class 130 (B)

Coil versions, DC coil

STD	LED bipolar	Coil code	Rated voltage VDC	Coil resistance Ω±10% ¹⁾	Rated power W
		PD ²⁾			
		LED+			
		PD ²⁾			
Coil versions, DC coil, RM5, RM6					
006	L06	0A6	6	24	1.5
012	L12	0B2	12	86	1.7
024	L24	0C4	24	345	1.7
048	L48	0E8	48	1340	1.7
060	L60	0G0	60	2200	1.6
110	M10	1B0	110	7300	1.7
221	N21	2C1	220	30000 ¹⁾	1.6

Coil versions, DC coil, RMB

012	-	-	12	62.6	2.3
024	-	-	24	250	2.3

Operate voltage, DC coil 75% of rated coil voltage

Release voltage, DC coil 10% of rated coil voltage

1) Coil resistance ±15%,

2) Protection diode PD; standard polarity: +A1 / -A2.

All figures are given for coil without pre-energization, at ambient temperature +23°C.

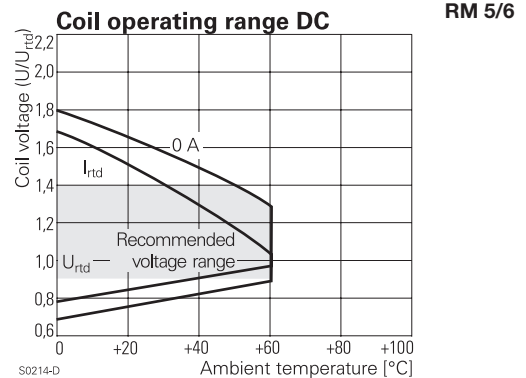

Power Relay RM 5/6/B 3mm (Continued)

Coil Data (continued)

Coil versions, AC coil

Coil code	Rated voltage	Operate voltage	Release voltage	Coil resistance	Rated coil power
STD	LED	VAC	VAC	VAC	50/60Hz
				$\Omega \pm 10\%^{1)}$	VA

Coil versions, AC-coil, RM5, RM6

506	R06	6	4.8/5.1	1.8	4.7	2.86/2.36
512	R12	12	9.6/10.2	3.6	19.5	2.71/2.27
524	R24	24	19.2/20.4	7.2	80	2.62/2.00
548	R48	48	38.4/40.8	14.4	320	2.60/2.17
560	R60	60	48.0/51.0	18.0	500	2.62/2.20
615	S15	115	92.0/97.8	34.5	1850	2.65/2.22
730	T30	230	184.0/195.5	69.0	7500	2.69/ 2.26
900	V00	400	320.0/340.0	120.0	23500 ¹⁾	2.61/2.20

1) Coil resistance $\pm 15\%$.

All figures are given for coil without pre-energization, at ambient temperature $+23^\circ\text{C}$.

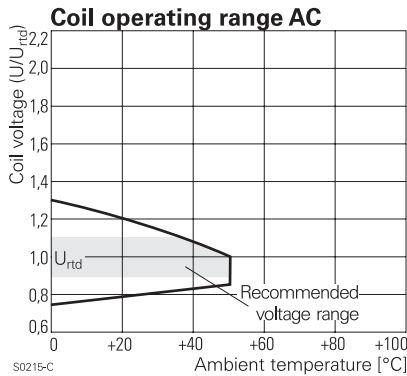

Accessories

For details see datasheet

[Accessories Power Relay RM](#)

Note: indicated contact ratings and electrical endurance data for direct wiring of relays (according IEC 61810-1); for relays mounted on sockets deratings may apply.

PCB layout / terminal assignment

Bottom view on pins

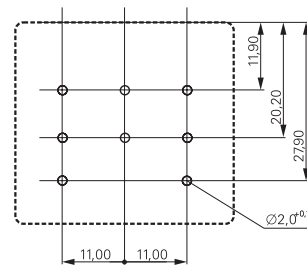

3 form A (3 NO) contacts

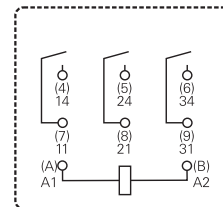

2 form A (2 NO) contacts

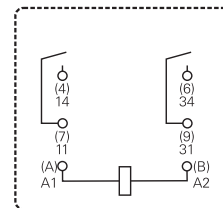

Insulation Data

	RM5	RM6	RMB
Initial dielectric strength			
between open contacts	2500Vrms	2500Vrms	2500Vrms
between contact and coil	2500Vrms	2500Vrms	2500Vrms
between adjacent contacts	2500Vrms	2500Vrms	2500Vrms
Initial surge withstand voltage	4000V	4000V	4000V
between contact and coil	5000V	4000V	4000V
between adjacent contacts, RM5	6000V	-	-
Clearance/creepage			
between contact and coil		$\geq 4.0/14.9\text{mm}$	
between adjacent contacts		$\geq 6.1/7.3\text{mm}$	
Material group of insulation parts		IIIa	

Other Data

	RM5	RM6	RMB
Material compliance: EU RoHS/ELV, China RoHS, REACH, Halogen content refer to the Product Compliance Support Center at www.te.com/customer-support/rohssupportcenter			
Ambient temperature for mounting/handling in operation		-20 to 40°C	
DC coil	-40 to 50°C	-40 to 60°C	-40 to 50°C
AC coil	-40 to 50°C	-40 to 50°C	-
Category of environmental protection IEC 61810		RTI - dust protected	
Vibration resistance (functional)		12 g, 30 to 150 Hz	
Terminal type		PCB-THT, plug-in, quick-connect (QC)	
Cover retention, pull/push force		100/100N	
Mounting position		versions with test button not to be mounted with button on top	
Weight		81g	
Resistance to soldering heat THT IEC 60068-2-20		$270^\circ\text{C}/10\text{s}$	
Packaging unit		10/25 pcs.	

Power Relay RM 5/6/B 3mm (Continued)

Dimensions

Plain cover, plug-in version

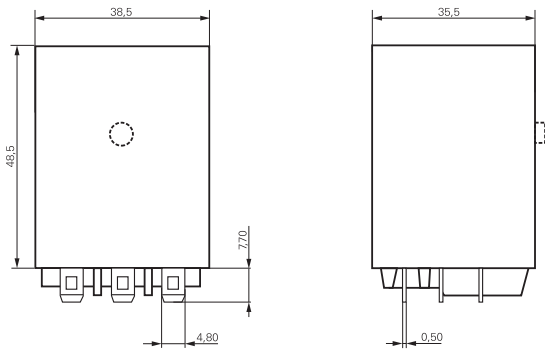

PCB version

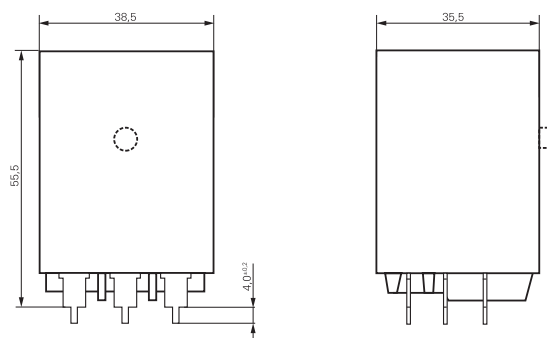

Cover with mounting brackets, 6.3mm quick connect (4.8mm available)

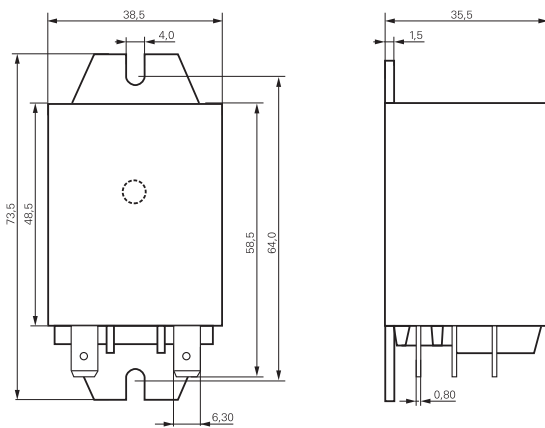

Cover with DIN-snap-on attachment (6.3mm quick connect only)
horizontal vertical

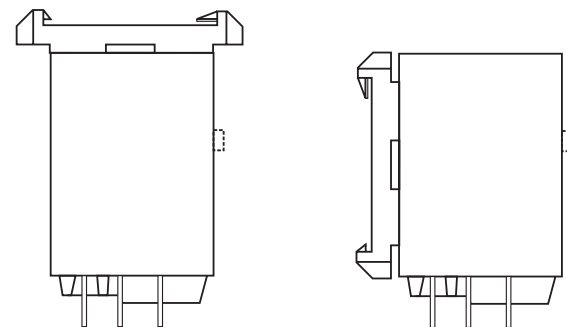

Product code structure

Typical product code **RM 5 0 2 524**

Type	RM Power relay RM5/6/B 3mm			
Contact arrangement	5 2 form A contacts (2 NO), 16A	6 3 form A contacts (3 NO), 10A	B 3 form A contacts (3 NO), 16A	
Version	0 AgCdO, without test button, without mechanical indicator 2 AgNi90/10, without test button, without mechanical indicator 3 AgCdO, with test button, without mechanical indicator 7 AgNi90/10, with test button, without mechanical indicator			
Enclosure	2 Plain cover, 4.8mm quick connect terminals 3 Cover with mounting brackets, 4.8mm quick connect terminals 5 Cover with mounting brackets, 6.3mm quick connect terminals 7 PCB version 8 Cover with DIN-snap-on attachment, horizontal, 6.3mm quick connect terminals 9 Cover with DIN-snap-on attachment, vertical, 6.3mm quick connect terminals			
Coil	Coil code: please refer to coil versions table			

Power Relay RM 5/6/B 3mm (Continued)

Product key	Contacts	Cont. material	Version	Enclosure	Coil	Coil	Part number
RM502024	2 form A,	AgCdO	Without	Plain cover	DC coil	24VDC	6-1393146-1
RM522012	2 NO contacts	AgNi	test button	QC 4.8mm		12VDC	2-1415546-4
RM502524	16A	AgCdO	without		AC coil	24VAC	6-1393146-2
RM502615		AgCdO	mech. indicator			115VAC	6-1393146-3
RM502730		AgCdO				230VAC	6-1393146-4
RM503024		AgCdO		Mounting brackets	DC coil	24VDC	8-1393148-0
RM503615		AgCdO		quick c. 4.8mm	AC coil	115VAC	6-1393146-5
RM505024		AgCdO		Mounting brackets	DC coil	24VDC	8-1393148-3
RM525012		AgNi		QC 6.3mm	DC coil	12VDC	5-1415544-6
RM505615		AgCdO			AC coil	115VAC	6-1393146-6
RM505730		AgCdO				230VAC	9-1393149-9
RM525730		AgNi				230VAC	2-1415546-5
RM507024		AgCdO		PCB version	DC coil	24VDC	1393844-1
RM527024		AgNi				24VDC	2-1415546-6
RM507524		AgCdO			AC coil	24VAC	5-1415008-1
RM507615		AgCdO				115VAC	6-1415015-1
RM507730		AgCdO				230VAC	1415008-1
RM528730		AgNi		DIN-snap-on horizontal		230VAC	2-1415546-7
RM535024		AgCdO	With test button	Mounting brackets	DC coil	24VDC	7-1393146-2
RM535524		AgCdO	w/o mech.indicator	QC 6.3mm	AC coil	24VAC	9-1393148-0
RM602024	3 form A,	AgCdO	Without	Plain cover	DC coil	24VDC	1393844-4
RM622024	3 NO contacts	AgNi	test button	QC 4.8mm		24VDC	2-1415546-8
RM602615	10A	AgCdO	without		AC coil	115VAC	9-1393148-7
RM605730		AgCdO	mech. indicator	Mount.br. q.c.6.3		230VAC	7-1393146-6
RM607024		AgCdO		PCB version	DC coil	24VDC	1393844-6
RM627012		AgNi				12VDC	2-1415546-9
RM627730		AgNi				230VAC	3-1415546-0
RM607524		AgCdO			AC coil	24VAC	7-1393146-8
RM607615		AgCdO				115VAC	8-1415015-1
RM607730		AgCdO				230VAC	7-1393146-9
RM632024		AgCdO	With	Plain cover	DC coil	24VDC	8-1393146-0
RM632730		AgCdO	test button	QC 4.8mm	AC coil	230VAC	1393149-7
RM635024		AgCdO	without	Mount.br.QC 6.3	DC coil	24VDC	7-1393107-7
RM637024		AgCdO	mech. indicator	PCB version		24VDC	1393149-9
RMB07012	3 A (NO) cont. 16A	AgCdO	W/o test, indicator			12VDC	1-1415545-6
RMB07024		AgCdO				24VDC	2-1415543-7

Mouser Electronics

Authorized Distributor

Click to View Pricing, Inventory, Delivery & Lifecycle Information:

[TE Connectivity:](#)

[RM507024](#)