

THIS DOCUMENT IS THE PROPERTY OF
KEYSTONE ELECTRONICS CORP. AND
SHALL NOT BE REPRODUCED, DISTRIBUTED
OR USED AS A BASIS FOR MANUFACTURE
WITHOUT PRIOR WRITTEN PERMISSION
FROM KEYSTONE ELECTRONICS CORP.

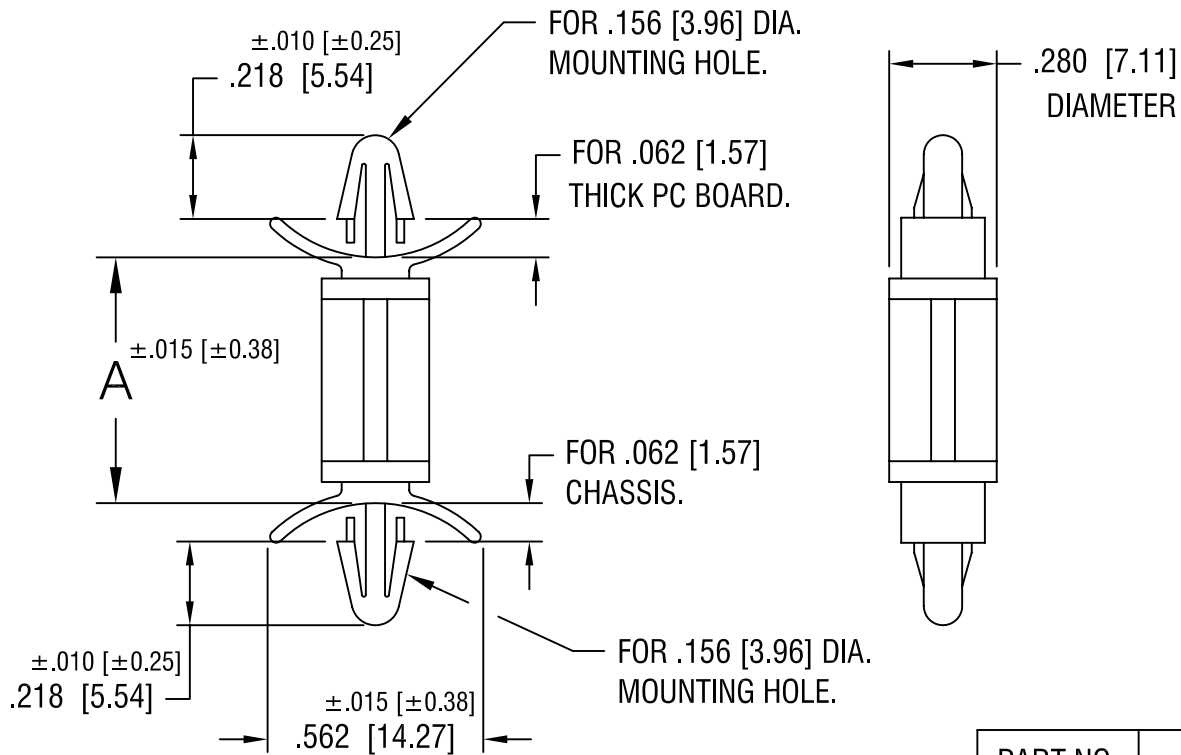

PART NO.	'A' DIM.
8815	.187 [4.74]
8816	.250 [6.35]
8817	.375 [9.52]
8818	.500 [12.70]
8819	.625 [15.87]
8820	.750 [19.05]
8821	.875 [22.22]

KEYSTONE ELECTRONICS CORP.

ASTORIA, N.Y. 11105-2017

PART NAME

PC LOCK-IN SUPPORT

MATERIAL

NYLON UL 94V-0

FINISH

-

DRN BY

BOONE

DATE

11.16.95

APPD

LN

SCALE

2X

TOLERANCES

INCH [MM]

DECIMAL $\pm .005$ [± 0.15]

ANGULAR $\pm 1^\circ$

UNLESS OTHERWISE SPECIFIED

CODE

C

DWG NO.

8815-8821

DATE

DESCRIPTION

REV.

Mouser Electronics

Authorized Distributor

Click to View Pricing, Inventory, Delivery & Lifecycle Information:

[Keystone Electronics:](#)

[8815](#)