

80×80×25 mm

San Ace 80 9R type    Model 109R0812E401 is not certified.



General Specifications

- Material Frame: Plastic (Flammability: UL 94V-0), Impeller: Plastic (Flammability: UL 94V-1)
- Expected life See the table below. (L10 life: 90% survival rate for continuous operation in free air at 60°C, rated voltage)
- Motor protection function Locked rotor burnout protection, Reverse polarity protection
For details, please refer to p. 547.
- Dielectric strength 50/60 Hz, 500 VAC, for 1 minute (between lead wire conductors and frame)
- Insulation resistance 10 MΩ or more with a 500 VDC megger (between lead wire conductors and frame)
- Sound pressure level (SPL) At 1 m away from the air inlet
- Storage temperature -30 to +70°C (Non-condensing)
- Lead wire ⊕Red ⊖Black or Blue (Sensor) Yellow
- Mass 110 g

Specifications

The models listed below **have ribs and pulse sensors.** For models without ribs, append "1" to the end of model numbers.

Model no.	Rated voltage [V]	Operating voltage range [V]	Rated current [A]	Rated input [W]	Rated speed [min ⁻¹]	Max. airflow [m ³ /min] [CFM]	Max. static pressure [Pa] [inchH ₂ O]	SPL [dB (A)]	Operating temperature [°C]	Expected life [h]	
109R0805F401	5	4.5 to 5.5	0.25	1.25	2600	0.92 32.5	28.4 0.114	26	-20 to +70	60000/60°C	
109R0805M401			0.17	0.85	2350	0.83 29.3	22.5 0.09	23			
109R0812G401	12	10.8 to 13.2	0.37	4.44	4500	1.5 53.0	80.4 0.323	40	-20 to +60	40000/60°C	
109R0812E401			0.24	2.88	3700	1.31 46.3	57.8 0.232	35			
109R0812S401			0.18	2.16	3400	1.2 42.4	48.0 0.193	34			
109R0812H401			0.13	1.56	2900	1.03 36.4	35.3 0.142	29			
109R0812F401		6 to 13.8	0.11	1.32	2600	0.92 32.5	28.4 0.114	26	-20 to +70	60000/60°C	
109R0812M401			0.09	1.08	2350	0.83 29.3	22.5 0.09	23			
109R0812L401			7 to 13.8	0.06	0.72	1850	0.65 23.0	14.7 0.059			20
109R0824G401				0.2	4.8	4500	1.5 53.0	80.4 0.323			40
109R0824S401	24	20.4 to 26.4	0.1	2.4	3400	1.2 42.4	48.0 0.193	34	-20 to +60	40000/60°C	
109R0824H401			0.07	1.68	2900	1.03 36.4	35.3 0.142	29			
109R0824F401			0.06	1.44	2600	0.92 32.5	28.4 0.114	26			
109R0824M401		12 to 27.6	0.05	1.2	2350	0.83 29.3	22.5 0.09	23	-20 to +70	60000/60°C	
109R0824L401			14 to 27.6	0.04	0.96	1850	0.65 23.0	14.7 0.059			20
109R0848K401				0.1	4.8	4600	1.56 55.1	88.4 0.355			41
109R0848S401	48	40.8 to 55.2	0.06	2.88	3400	1.2 42.4	48.0 0.193	34	-20 to +70	60000/60°C	

The following sensor and control options are available for selection.

Differs according to the model. Refer to the table on pp. 564 to 565. Without sensor Lock sensor

Airflow - Static Pressure Characteristics

109R0805F401 With pulse sensor

Operating voltage range

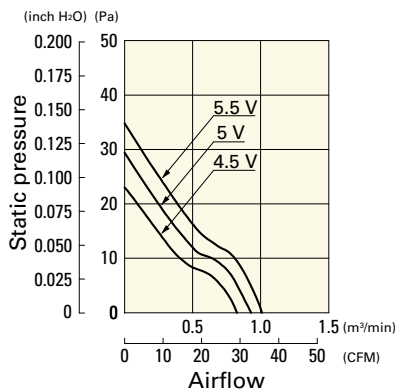

109R0805M401 With pulse sensor

Operating voltage range

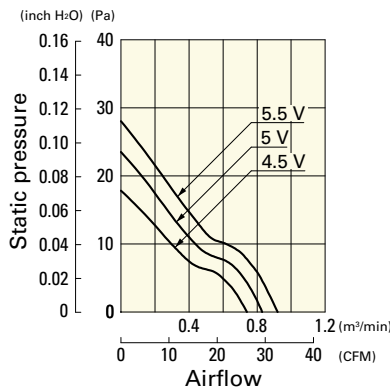

109R0812G401 With pulse sensor

Operating voltage range

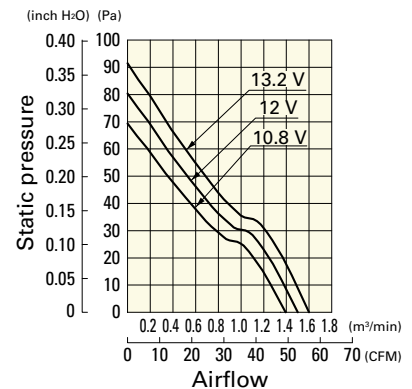

Airflow - Static Pressure Characteristics

109R0812E401 With pulse sensor

Operating voltage range

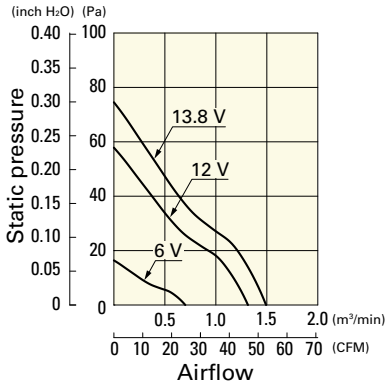

109R0812S401 With pulse sensor

Operating voltage range

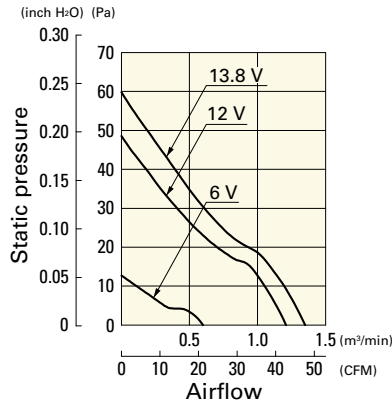

109R0812H401 With pulse sensor

Operating voltage range

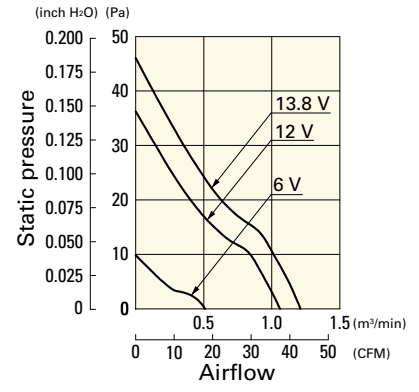

109R0812F401 With pulse sensor

Operating voltage range

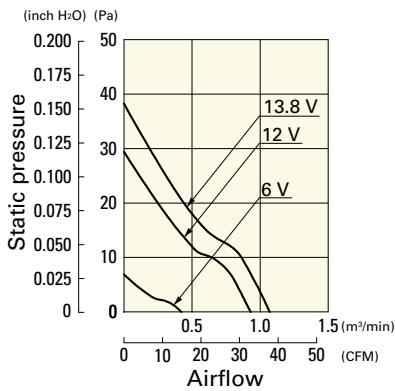

109R0812M401 With pulse sensor

Operating voltage range

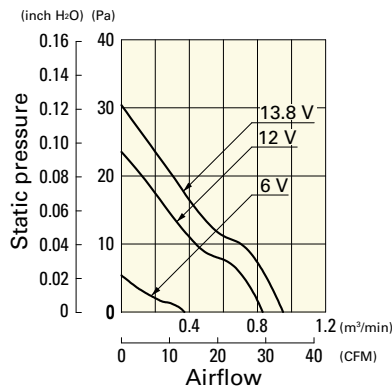

109R0812L401 With pulse sensor

Operating voltage range

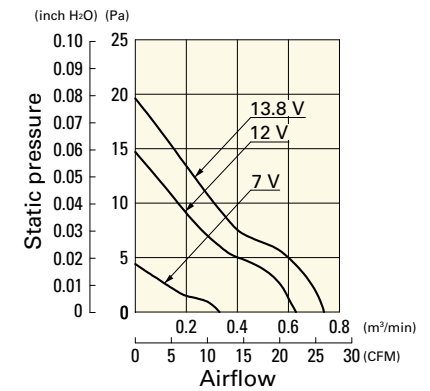

109R0824G401 With pulse sensor

Operating voltage range

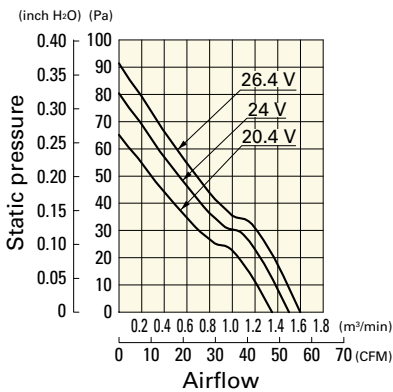

109R0824S401 With pulse sensor

Operating voltage range

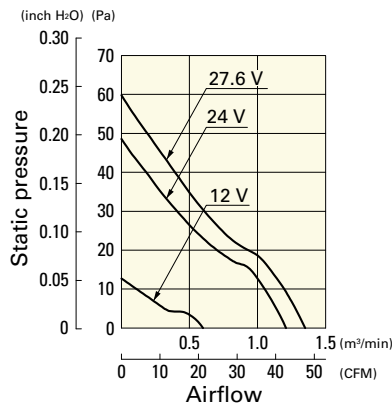

109R0824H401 With pulse sensor

Operating voltage range

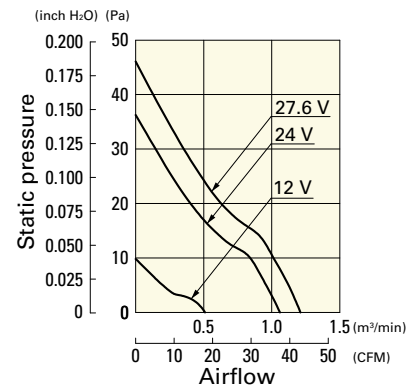

109R0824F401 With pulse sensor

Operating voltage range

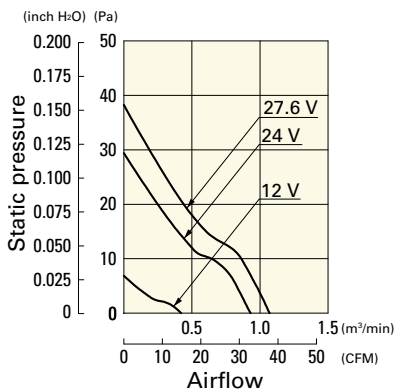

109R0824M401 With pulse sensor

Operating voltage range

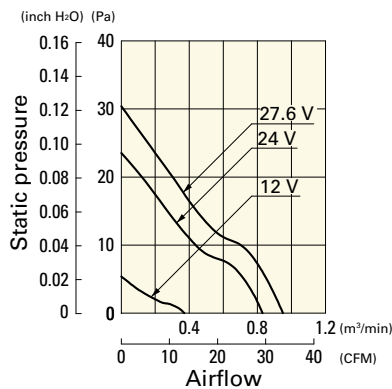

109R0824L401 With pulse sensor

Operating voltage range

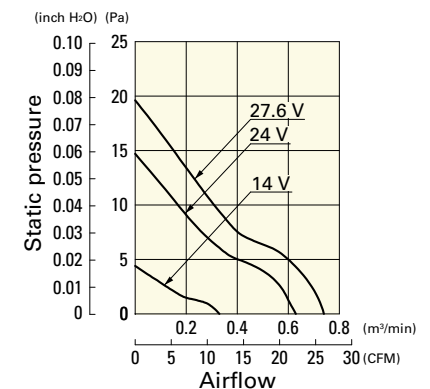

Airflow - Static Pressure Characteristics

109R0848K401 With pulse sensor

Operating voltage range

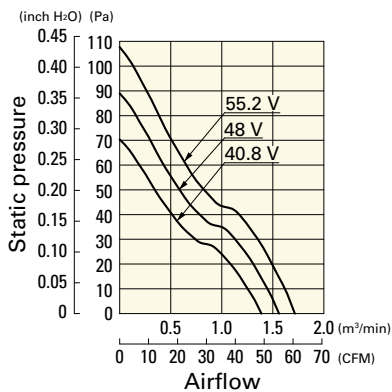

109R0848S401 With pulse sensor

Operating voltage range

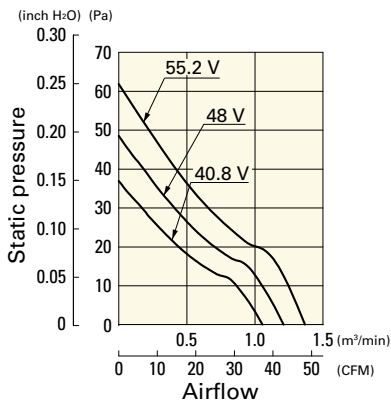

Dimensions (unit: mm) (With ribs)

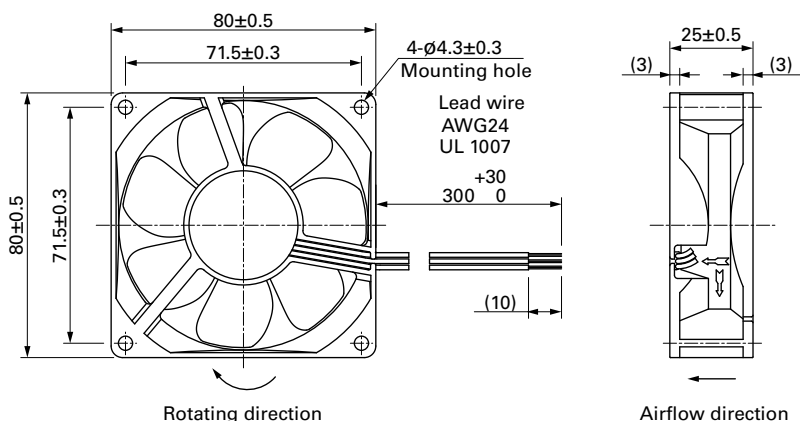

Reference Dimensions of Mounting Holes and Vent Opening (unit: mm)

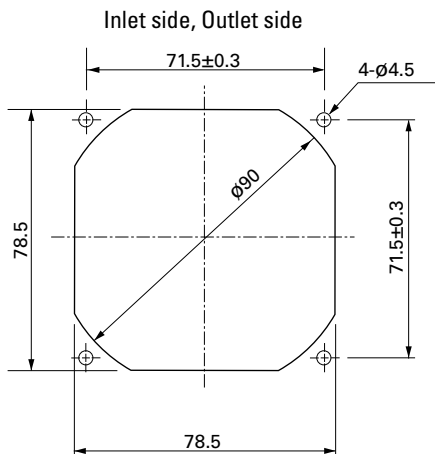

Options

Finger guards

page: p. 532

Model no.: 109-049E, 109-049H, 109-049C

Resin finger guards

page: p. 539

Model no.: 109-1002G

Resin filter kits

page: p. 540

Model no.: 109-1002F13 (13PPI), 109-1002F20 (20PPI), 109-1002F30 (30PPI), 109-1002F40 (40PPI)

Mouser Electronics

Authorized Distributor

Click to View Pricing, Inventory, Delivery & Lifecycle Information:

Sanyo Denki:

[109R0812F402](#) [109R0812G4011](#) [109R0812M4011](#) [109R0812M402](#) [109R0824H401](#) [109R0824M4021](#)
[109R0824S401](#) [109R0824H402](#) [109R0812F4011](#) [109R0824G4011](#) [109R0824S4021](#) [109R0848K4021](#)
[109R0812F401](#) [109R0812S401](#) [109R0824G401](#) [109R0848K401](#) [109R0812G402](#) [109R0824F4011](#) [109R0812H402](#)
[109R0812H4011](#) [109R0848S402](#) [109R0812F4021](#) [109R0812G4021](#) [109R0812M4021](#) [109R0824H4021](#)
[109R0812G401](#) [109R0824M402](#) [109R0824H4011](#) [109R0812H4021](#) [109R0812H401](#) [109R0805F4011](#)
[109R0812S4011](#) [109R0824S4011](#) [109R0805M401](#) [109R0812M401](#) [109R0812L401](#) [109R0824L401](#)
[109R0824L4011](#) [109R0824F401](#) [109R0824M4011](#) [109R0812L4011](#) [109R0848K4011](#) [109R0824M401](#)
[109R0848S401](#) [109R0805F401](#) [109R0848K402](#) [109R0812E402](#) [109R0805F402](#) [109R0824F4D011](#)
[109R0824H4D01](#) [109R0812F4D011](#) [109R0812G4D01](#) [109R0824H4D011](#) [109R0848K4D01](#) [109R0824L402](#)
[109R0812L402](#) [109R0824F402](#) [109R0805F4021](#) [109R0805M4021](#) [109R0848S4021](#) [109R0824L4D011](#)
[109R0824S402](#) [109R0805M402](#) [109R0812L4D01](#) [109R0812H4D01](#) [109R0848K4D011](#) [109R0824M4D01](#)
[109R0824G4D011](#) [109R0824M4D011](#) [109R0824G4021](#) [109R0812M4D011](#) [109R0824L4021](#) [109R0848S4D01](#)
[109R0812S4021](#) [109R0812H4D011](#) [109R0812S4D011](#) [109R0824F4D01](#) [109R0824G4D01](#) [109R0812L4021](#)
[109R0812S402](#) [109R0824G402](#) [109R0805F4D01](#) [109R0824S4D011](#) [109R0824L4D01](#) [109R0812F4D01](#)
[109R0824F4021](#) [109R0824S4D01](#) [109R0812G4D011](#) [109R0812S4D01](#) [109R0805M4D01](#) [109R0812L4D011](#)
[109R0812M4D01](#) [109R0812E401](#) [109R0805M4011](#) [109R0848S4011](#)