

THIS DRAWING IS UNPUBLISHED. RELEASED FOR PUBLICATION
 © COPYRIGHT - By - ALL RIGHTS RESERVED.

LOC	DIST	REVISIONS					
AF	50	P	LTR	DESCRIPTION	DATE	DWN	APVD
			J	REVISED PER ECR-12-013459	28NOV2012	KH	PD

1 CONTINUOUS STRIP ON REELS.

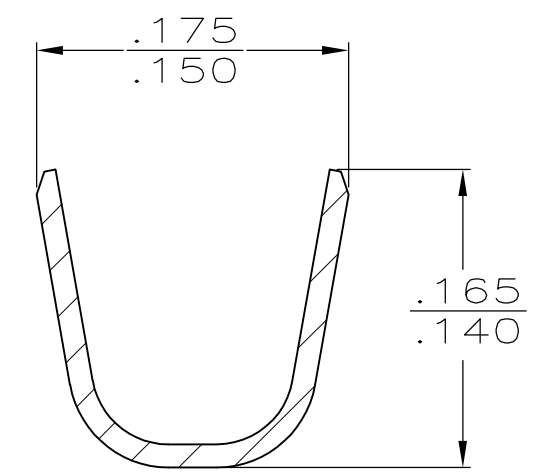
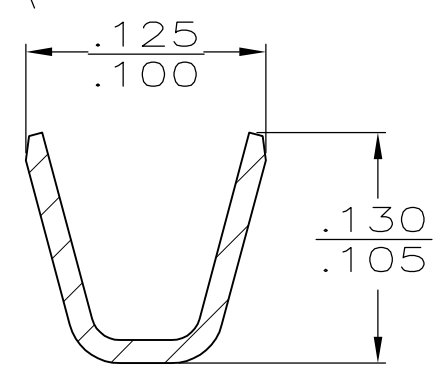
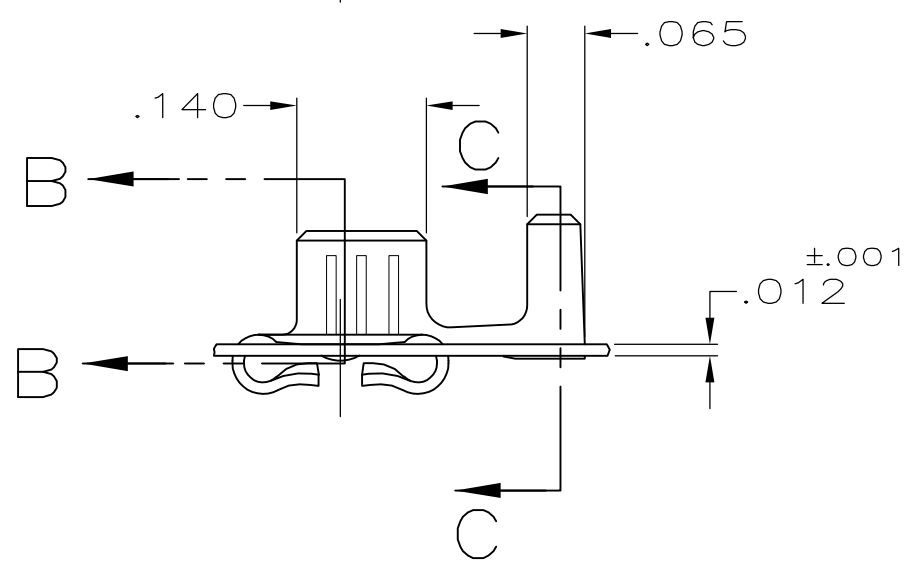
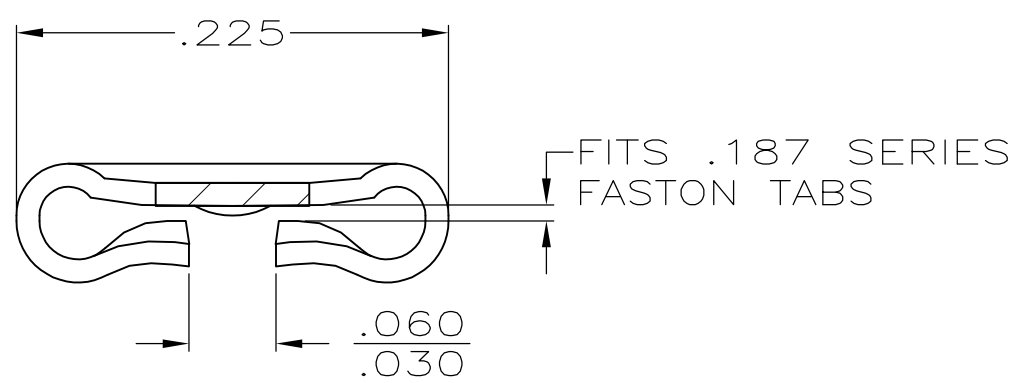
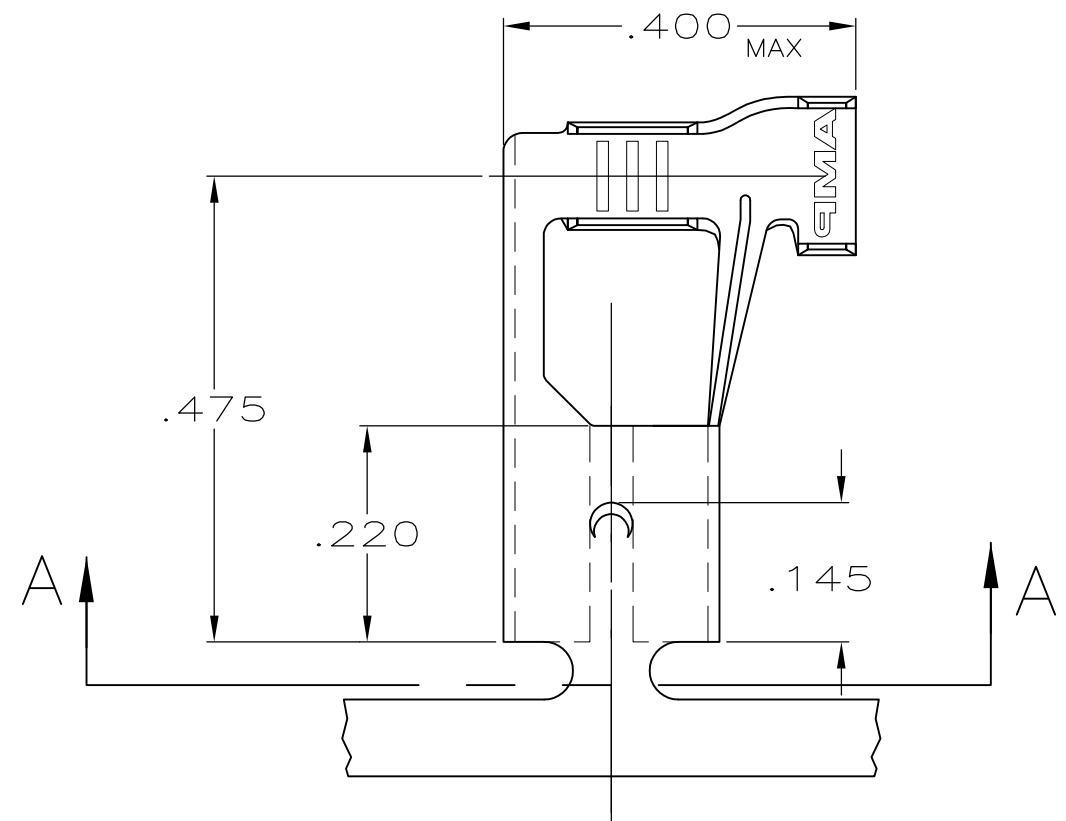

.090-.130 DIA	20-16 AWG	TIN	.020	60755-2
INSULATION RANGE	WIRE SIZE	FINISH	MATING TAB THK #.001	60755-1
				PART NUMBER

THIS DRAWING IS A CONTROLLED DOCUMENT.		DWN	JR RUTH	11/5/91	TE Connectivity RECEPTACLE, FASTON, FLAG, .187 SERIES								
DIMENSIONS: INCHES		CHK	MS FEHER	11/5/91									
TOLERANCES UNLESS OTHERWISE SPECIFIED:		APVD	C MEYERS	11/5/91									
0 PLC ± - 1 PLC ± - 2 PLC ± - 3 PLC ± .015 4 PLC ± - ANGLES ± -		PRODUCT SPEC		NAME									
MATERIAL	BRASS	FINISH	SEE TABLE	WEIGHT	-	SIZE	A3	CAGE CODE	00779	DRAWING NO	C-60755	RESTRICTED TO	-
CUSTOMER DRAWING						SCALE	5:1	SHEET	1 OF 1	REV	J		

Mouser Electronics

Authorized Distributor

Click to View Pricing, Inventory, Delivery & Lifecycle Information:

[TE Connectivity:](#)

[60755-2](#)