

PI31xx-xx-EVAL1 ZVS Isolated DC-DC Converter Evaluation Board

Chris Swartz
Principal Applications Engineer



Contents	Page
Introduction	1
PI31xx Series	
Product Description	2
Board Connections	2
Thermal Considerations	4
Ordering Information	14

Introduction

The PI31xx-xx-EVAL1 evaluation board allows the user to test the basic operating principles of the PI31xx series of high-density DC-DC power converters and experience the performance and value of this solution compared to alternate conventional solutions. Each evaluation board is populated with the components that could be used in a final design. It is not designed or intended to be used in end-product applications. Please read this document prior to the connection of test equipment and refer to the product data sheet for device specifications, descriptions and characteristics. Remember to follow good lab safety practices and use safety glasses at all times.

The PI31xx-xx-EVAL1 is configured to support one single input and one single output. Each board offers pin-strap options for trimming the output voltage up and down, turning the converter on and off and adding EMI system “Y” capacitors. Additional parts are included to compensate for line impedance associated with long leads from the bench power supply to the converter. Additional component footprints are made available to allow the user to test different design configurations that may be required to meet their end needs. Kelvin-type test points are included to allow for easy and convenient connections of testing instruments for evaluation of efficiency, line/load regulation and transient response. A low-impedance oscilloscope connection using a Johnson jack is included for ripple measurement and evaluation of the output voltage during transient events. Each demo board is equipped with a heat sink to allow high-power operation with a small amount of air flow and to allow operation of the board over various temperature extremes.

Figure 1
PI31xx-xx-EVAL1
Evaluation Board



PI31xx Series Product Description

The PI31xx operates over a wide-range input, delivering 50 or 60W output power depending on the individual model number. The PI31xx series is available in a space-saving surface-mountable 0.87 x 0.65 x 0.265in Power-System-in-a-Package (PSiP), achieving ~50% space reduction versus alternative solutions.

The switching frequency of 900kHz allows for small input and output filter components which further reduces the total size and cost of the overall system solution. The output voltage is sensed and fed back to the internal controller using a proprietary isolated magnetic feedback scheme which allows for high bandwidth and good common-mode noise immunity.

The PI31xx series requires no external feedback compensation and offers a total solution with a minimum number of external components. A rich feature set is offered, including +10%, -20% output voltage trim capability (depending on the model number), remote enable, overvoltage protection, adjustable soft start, overcurrent protection with auto restart to protect against both short-circuit and overload, and over and under input voltage lockout. A unique temperature monitor and protection circuit is included that provides an analog voltage proportional to the internal die temperature, as well as overtemperature shut down, restart and overtemperature-fault alarm signal.

Board Connections

1. Connect Test Equipment

- a. Connect the input DC power supply to the target board as shown in Figure 6. The negative terminal should be wired to -IN and the positive terminal should connect to the positive terminal of the DMM wired as a DC Ammeter. Be sure that the proper sized wires are used to allow minimum voltage drop for a maximum input current of up to 4A. Use ring lugs mated to the included fasteners on the evaluation board. If your input power supply has remote sense capability, it can be wired to the INN and INP test points if desired. Connect the positive terminal of the DMM to the +IN lug on the evaluation board.
- b. Connect the primary side DMM (for measuring the input voltage) to INN and INP respectively.
- c. Connect the oscilloscope as shown in Figure 6 if you are planning to measure both primary and secondary signals at the same time. If you do not have an isolated differential amplifier, it is important to note that simultaneous measurement of both primary and secondary referenced signals using an oscilloscope with a grounded chassis is not recommended, as it will short circuit the primary to secondary isolation barrier. Floating the oscilloscope is also not recommended due to the large capacitance introduced by this long standing practice. The best practice is to use an isolated differential amplifier or use an oscilloscope with isolated channels. That is, the input returns are isolated from each other and earth ground.
- d. Connect the output DC DMM to the test points OUTN and OUTP. These test points are done in a Kelvin type manner so that they have no high current flowing in them.
- e. Connect the DC Load to the output lugs OUT+ and OUT-. It is critical for this connection to be low inductance.

2. Default Pin Strap Configuration

a. Ensure the pin straps are in the following default locations before proceeding:

- ENABLE = Not Used (enabled)
- TRIM_UP = Not Used
- TRIM_DN = Not Used
- OPT1 = Not Used
- OPT2 = Not Used

3. Pin Strap Functions

- a. ENABLE – Adding a strap on this pin will cause the converter to shut down.
- b. TRIM_UP – Adding a strap in this location will adjust the output voltage up by 10%.
- c. TRIM_DN – Adding a strap in this location will adjust the output voltage down by 10%. Only one strap can be connected at a time. If both trim straps are out, the output voltage should be set to the model's nominal output.

4. Trimming and Soft Start

a. For those customers who wish to trim to another voltage by changing the preset trim resistors to another value, the trim equation shown in Figure 2 can be used:

$$R_{LOW} = (-V_{DESIRED}) \cdot \frac{R_{REF1}}{(-V_{OUT_NOM}) + V_{DESIRED}}$$

$$R_{HIGH} = (-R_{REF1}) \cdot \frac{(-V_{OUT_NOM}) \cdot V_{ERO} + V_{DESIRED} \cdot V_{REF}}{V_{REF} \cdot ((-V_{OUT_NOM}) + V_{DESIRED})}$$

Where:

R1 = R_{LOW}

R3 = R_{HIGH}

V_{ERO} = 4.9 and

V_{REF} can be found in the appropriate model datasheet.

Figure 3 shows an equation for soft-start configuration where C7 = C_{REF}

$$C_{REF} = \frac{T_{SS_DESIRED} - 230 \cdot 10^{-6}}{23000}$$

Figure 2
PI31xx trim equation

Figure 3
PI31xx soft-start equation

Figure 4
PI31xx trimming
equivalent circuit

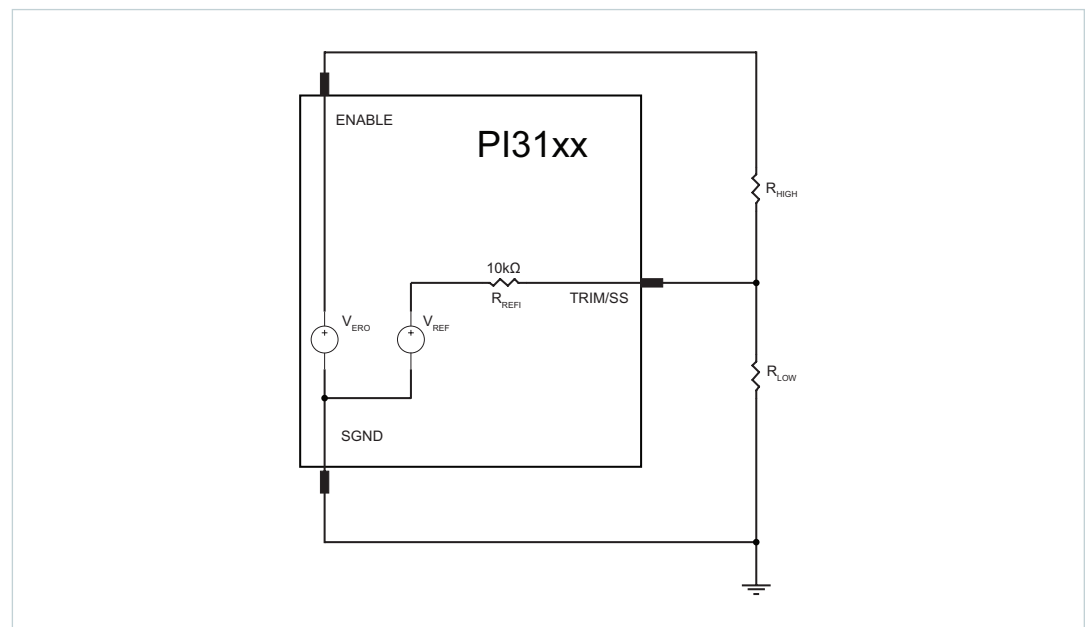

Thermal Considerations

The PI31xx-xx-EVAL1 is supplied with optional heat sinks. At present, Vicor offers four different heat sink options to accommodate the customers space and cooling needs. Heat sinks are available in two sizes, one with 6.3mm fins and the other with 11mm fins. Each of those heat sinks can be ordered with a specific air flow direction in mind, both cross flow and longitudinal are supported. Please refer to the product website www.vicorpower.com for more information.

Table 1
PI31xx-xx-EVAL1
input-output pin description

Pin Name	Type	Description
IN+	Input/Lug	Primary side positive input voltage terminal.
IN-	Input/Lug	Primary side negative input voltage terminal.
OUT+	Output/Lug	Isolated secondary DC output voltage positive terminal.
OUT-	Output/Lug	Isolated secondary DC output voltage negative terminal
TM	Test/Pin	Temperature measurement output pin with respect to SGND. $3V = 300^{\circ}K$ $10mV/^{\circ}K$.
SGND	Test/Pin	Signal ground, primary side referenced.
TRIM/SS	Test/Pin	Monitor pin for the soft-start voltage and trim voltage reference with respect to SGND.
ENABLE	Test/Pin	Allows for monitoring of the ENABLE signal with respect to SGND
INN	Test/Pin	Kelvin sense connection for input supply (-) and input voltage measurement test point.
INP	Test/Pin	Kelvin sense connection for input supply (+) and input voltage measurement test point.
YN	Output/Pad	Optional test pad for connection of optional "YN" capacitor to external system ground.
YP	Output/Pad	Optional test pad for connection of optional "YP" capacitor to external system ground.
OUTP	Test/Pin	Kelvin sense connection for output voltage (+) and output voltage measurement test point.
OUTN	Test/Pin	Kelvin sense connection for output voltage (-) and output voltage measurement test point.
OUT	Test/Pin	PCB test jack for low noise measurement of the output voltage.

Table 2
PI31xx-xx-EVAL1
evaluation board
pin strap and
jumper description

Name	Description
ENABLE	If strap is installed, unit is turned off. If strap is removed, unit will be enabled.
TRIM_UP	If strap is installed, trims output voltage up 10%.
TRIM_DN	If strap is installed, trims output voltage down 10%.
OPT1	Allows optional connection of heat-sink assembly to second return (-IN).
OPT2	Allows optional connection of heat-sink assembly to secondary return (-OUT).

Table 3
PI31xx-xx-EVAL1
evaluation board
maximum I/O ratings

Name	Max Voltage	Max Current
IN+	100V	20A
IN-	100V	20A
OUT+	20V	20A
OUT-	20V	20A
TRIM_DN	10V	100mA
OPT1	10V	100mA
OPT2	10V	100mA
OUT	10V	100mA
INP	10V	100mA
INN	10V	100mA
ENABLE	10V	100mA
TRIM/SS	10V	100mA
SGND	10V	100mA
TM	10V	100mA
OUTP	20V	100mA
OUTN	20V	100mA

Figure 5
Schematic diagram

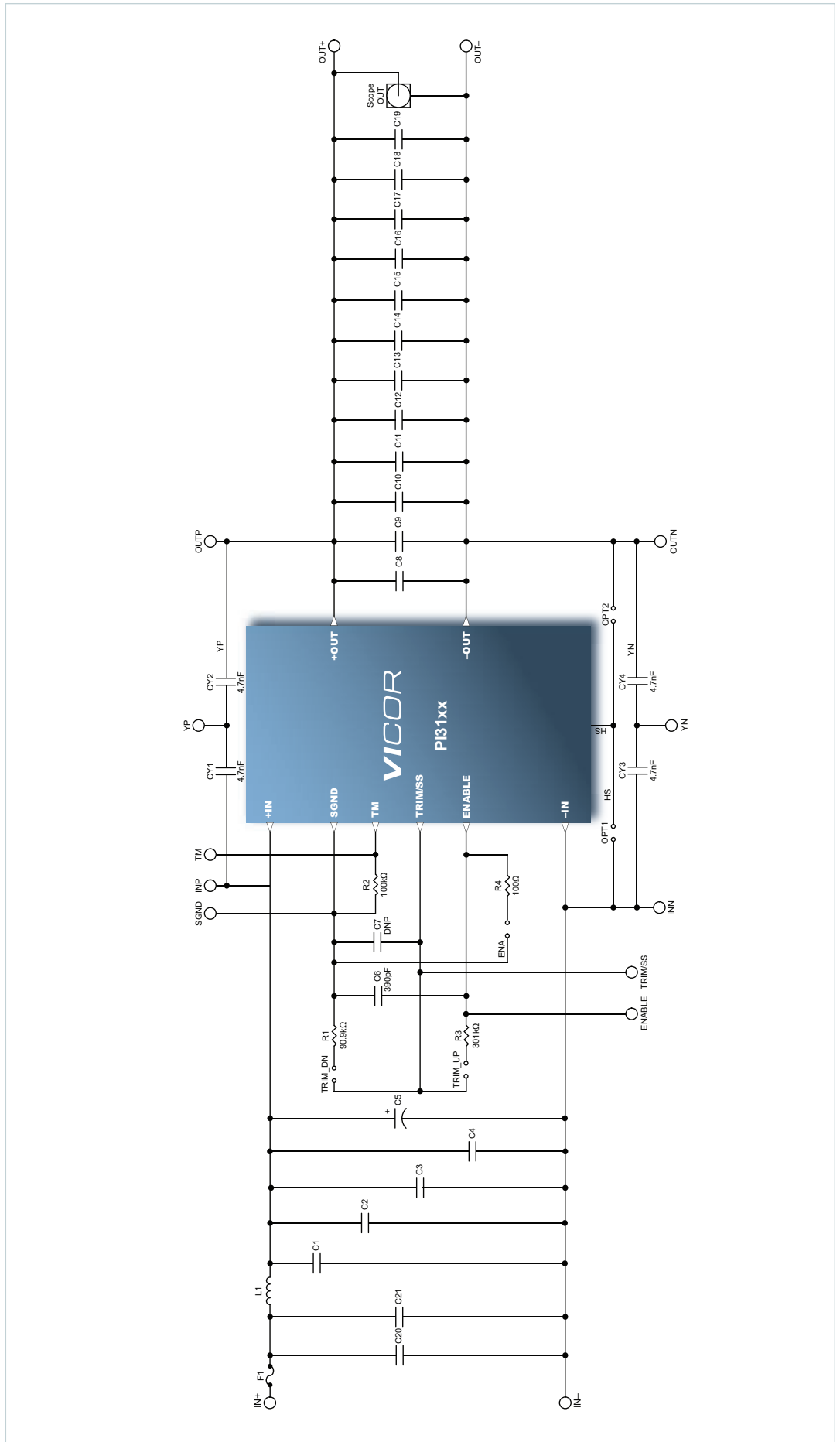

Table 4
PI3101-00-EVAL1
evaluation board BOM

Item	Qty	Ref Design	Part Number	Value	U/M	Description
1	1	U1	PI3101-00-HVIZ	NA	EA	Vicor PI3101-00 High-Density PSiP
2	6	C8-C19	GRM21BR71A106KE5	10 μ	F	Murata X7R Ceramic Capacitor 10V or equiv.
3	6	C1-C4, C20-C21	GRM31CR72A105KE1	1 μ	F	Murata X7R Ceramic Capacitor 100V or equiv.
4	4	CY1-CY4	GRM31BR73A472K	4700p	F	Murata X7R Ceramic Capacitor 1kV or equiv.
5	1	L1	FP3-2R0-R	2 μ	H	Coilcraft Inductor
6	1	C6	08055C391KAT2A	390p	F	Kemet X7R Ceramic Capacitor 50V 0805
7	1	C5	EEU-FC2A470	47 μ	F	Panasonic Electrolytic Capacitor 100V
8	1	R1	MCR10EZPF9092	90.9k	Ω	Rohm Resistor 0805 1% or equiv.
9	1	R3	MCR10EZPF3013	301k	Ω	Rohm Resistor 0805 1% or equiv.
10	1	R2	MCR10EZPF1003	100k	Ω	Rohm Resistor 0805 1% or equiv.
11	1	R4	MCR10EZPF1000	100	Ω	Rohm Resistor 0805 1% or equiv.
12	1	F1	0154003DR	3	A	Littlefuse Fuseblock 3A SMT
13	8		5015KCT-ND	N/A	N/A	Digi-Key SMT PC Test Point
14	1	OUT	131503100	N/A	N/A	Tektronix Test Jack Assembly
15	6	ENABLE, TRIM_UP, TRIM_DN	TSW-148-07-F-S	N/A	N/A	J,Header 0.1in

Table 5
PI3105-00-EVAL1
evaluation board BOM

Item	Qty	Ref Design	Part Number	Value	U/M	Description
1	1	U1	PI3105-00-HVIZ	NA	EA	Vicor PI3105-00 High-Density PSiP
2	6	C8-C19	GRM21BR71A475KE5	4.7 μ	F	Murata X7R Ceramic Capacitor 25V or equiv.
3	6	C1-C4, C20-C21	GRM31CR72A105KE1	1 μ	F	Murata X7R Ceramic Capacitor 100V or equiv.
4	4	CY1-CY4	GRM31BR73A472K	4700p	F	Murata X7R Ceramic Capacitor 1kV or equiv.
5	1	L1	FP3-R47-R	470n	H	Coilcraft Inductor
6	1	C6	08055C391KAT2A	390p	F	Kemet X7R Ceramic Capacitor 50V 0805
7	1	C5	EEU-FC2A470	47 μ	F	Panasonic Electrolytic Capacitor 100V
8	1	R1	MCR10EZPF9092	90.9k	Ω	Rohm Resistor 0805 1% or equiv.
9	1	R3	MCR10EZPF3013	301k	Ω	Rohm Resistor 0805 1% or equiv.
10	1	R2	MCR10EZPF1003	100k	Ω	Rohm Resistor 0805 1% or equiv.
11	1	R4	MCR10EZPF1000	100	Ω	Rohm Resistor 0805 1% or equiv.
12	1	F1	0154003DR	3	A	Littlefuse Fuseblock 3A SMT
13	8		5015KCT-ND	N/A	N/A	Digi-Key SMT PC Test Point
14	1	OUT	131503100	N/A	N/A	Tektronix Test Jack Assembly
15	6	ENABLE, TRIM_UP, TRIM_DN	TSW-148-07-F-S	N/A	N/A	J,Header 0.1in

Table 6
PI3106-00-EVAL1
evaluation board BOM

Item	Qty	Ref Design	Part Number	Value	U/M	Description
1	1	U1	PI3106-00-HVMZ	NA	EA	Vicor PI3106-00 High-Density PSiP
2	6	C8-C19	GRM21BR71E-225KA73L	2.2 μ	F	Murata X7R Ceramic Capacitor 25V or equiv.
3	6	C1-C4, C20-C21	GRM31CR71H-475KA12K	4.7 μ	F	Murata X7R Ceramic Capacitor 50V or equiv.
4	4	CY1-CY4	GRM31BR73A472K	4700p	F	Murata X7R Ceramic Capacitor 1kV or equiv.
5	1	L1	FP3-R47-R	470n	H	Coilcraft Inductor
6	1	C6	08055C391KAT2A	390p	F	Kemet X7R Ceramic Capacitor 50V 0805
7	1	C5	EEU-FC1J101L	100 μ	F	Panasonic Electrolytic Capacitor 63V
8	1	R1	MCR10EZPF9092	90.9k	Ω	Rohm Resistor 0805 1% or equiv.
9	1	R3	MCR10EZPF3013	301k	Ω	Rohm Resistor 0805 1% or equiv.
10	1	R2	MCR10EZPF1003	100k	Ω	Rohm Resistor 0805 1% or equiv.
11	1	R4	MCR10EZPF1000	100	Ω	Rohm Resistor 0805 1% or equiv.
12	1	F1	0154008DR	8	A	Littlefuse Fuseblock 8A SMT
13	8		5015KCT-ND	N/A	N/A	Digi-Key SMT PC Test Point
14	1	OUT	131503100	N/A	N/A	Tektronix Test Jack Assembly
15	6	ENABLE, TRIM_UP, TRIM_DN	TSW-148-07-F-S	N/A	N/A	J,Header 0.1in

Table 7
PI3106-01-EVAL1
evaluation board BOM

Item	Qty	Ref Design	Part Number	Value	U/M	Description
1	1	U1	PI3106-01-HVIZ	NA	EA	Vicor PI3106-01 High-Density PSiP
2	6	C8-C19	GRM21BR71E-225KA73L	2.2 μ	F	Murata X7R Ceramic Capacitor 25V or equiv.
3	6	C1-C4, C20-C21	GRM31CR71H-475KA12K	4.7 μ	F	Murata X7R Ceramic Capacitor 50V or equiv.
4	4	CY1-CY4	GRM31BR73A472K	4700p	F	Murata X7R Ceramic Capacitor 1kV or equiv.
5	1	L1	FP3-R47-R	470n	H	Coilcraft Inductor
6	1	C6	08055C391KAT2A	390p	F	Kemet X7R Ceramic Capacitor 50V 0805
7	1	C5	EEU-FC1J101L	100 μ	F	Panasonic Electrolytic Capacitor 63V
8	1	R1	MCR10EZPF9092	90.9k	Ω	Rohm Resistor 0805 1% or equiv.
9	1	R3	MCR10EZPF3013	301k	Ω	Rohm Resistor 0805 1% or equiv.
10	1	R2	MCR10EZPF1003	100k	Ω	Rohm Resistor 0805 1% or equiv.
11	1	R4	MCR10EZPF1000	100	Ω	Rohm Resistor 0805 1% or equiv.
12	1	F1	0154008DR	8	A	Littlefuse Fuseblock 8A SMT
13	8		5015KCT-ND	N/A	N/A	Digi-Key SMT PC Test Point
14	1	OUT	131503100	N/A	N/A	Tektronix Test Jack Assembly
15	6	ENABLE, TRIM_UP, TRIM_DN	TSW-148-07-F-S	N/A	N/A	J,Header 0.1in

Table 8
PI3108-00-EVAL1
evaluation board BOM

Item	Qty	Ref Design	Part Number	Value	U/M	Description
1	1	U1	PI3108-00-HVMZ	NA	EA	Vicor PI3108-00 High-Density PSiP
2	6	C8-C19	GRM21BR71A-106KE5	10 μ	F	Murata X7R Ceramic Capacitor 10V or equiv.
3	6	C1-C4, C20-C21	GRM31CR71H-475KA12K	4.7 μ	F	Murata X7R Ceramic Capacitor 50V or equiv.
4	4	CY1-CY4	GRM-31BR73A472K	4700p	F	Murata X7R Ceramic Capacitor 1kV or equiv.
5	1	L1	FP3-R47-R	470n	H	Coilcraft Inductor
6	1	C6	08055C391KAT2A	390p	F	Kemet X7R Ceramic Capacitor 50V 0805
7	1	C5	EEU-FC1J101L	100 μ	F	Panasonic Electrolytic Capacitor 63V
8	1	R1	MCR10EZPF9092	90.9k	Ω	Rohm Resistor 0805 1% or equiv.
9	1	R3	MCR10EZPF3013	301k	Ω	Rohm Resistor 0805 1% or equiv.
10	1	R2	MCR10EZPF1003	100k	Ω	Rohm Resistor 0805 1% or equiv.
11	1	R4	MCR10EZPF1000	100	Ω	Rohm Resistor 0805 1% or equiv.
12	1	F1	0154008DR	8	A	Littlefuse Fuseblock 8A SMT
13	8		5015KCT-ND	N/A	N/A	Digi-Key SMT PC Test Point
14	1	OUT	131503100	N/A	N/A	Tektronix Test Jack Assembly
15	6	ENABLE, TRIM_UP, TRIM_DN	TSW-148-07-F-S	N/A	N/A	J,Header 0.1in

Table 9
PI3109-00-EVAL1
evaluation board BOM

Item	Qty	Ref Design	Part Number	Value	U/M	Description
1	1	U1	PI3109-00-HVMZ	NA	EA	Vicor PI3109-00 High-Density PSiP
2	6	C8-C19	GRM21BR71A-106KE5	10 μ	F	Murata X7R Ceramic Capacitor 10V or equiv.
3	6	C1-C4, C20-C21	GRM31CR71H-475KA12K	4.7 μ	F	Murata X7R Ceramic Capacitor 50V or equiv.
4	4	CY1-CY4	GRM31BR73A472K	4700p	F	Murata X7R Ceramic Capacitor 1kV or equiv.
5	1	L1	FP3-R47-R	470n	H	Coilcraft Inductor
6	1	C6	08055C391KAT2A	390p	F	Kemet X7R Ceramic Capacitor 50V 0805
7	1	C5	EEU-FC1J101L	100 μ	F	Panasonic Electrolytic Capacitor 63V
8	1	R1	MCR10EZPF9092	90.9k	Ω	Rohm Resistor 0805 1% or equiv.
9	1	R3	MCR10EZPF3013	301k	Ω	Rohm Resistor 0805 1% or equiv.
10	1	R2	MCR10EZPF1003	100k	Ω	Rohm Resistor 0805 1% or equiv.
11	1	R4	MCR10EZPF1000	100	Ω	Rohm Resistor 0805 1% or equiv.
12	1	F1	0154008DR	8	A	Littlefuse Fuseblock 8A SMT
13	8		5015KCT-ND	N/A	N/A	Digi-Key SMT PC Test Point
14	1	OUT	131503100	N/A	N/A	Tektronix Test Jack Assembly
15	6	ENABLE, TRIM_UP, TRIM_DN	TSW-148-07-F-S	N/A	N/A	J,Header 0.1 "

Table 10
PI3109-01-EVAL1
evaluation board BOM

Item	Qty	Ref Design	Part Number	Value	U/M	Description
1	1	U1	PI3109-01-HVIZ	NA	EA	Vicor PI3109-01 High-Density PSiP
2	6	C8-C19	GRM21BR71A-106KE5	10 μ	F	Murata X7R Ceramic Capacitor 10V or equiv.
3	6	C1-C4, C20-C21	GRM31CR71H-475KA12K	4.7 μ	F	Murata X7R Ceramic Capacitor 50V or equiv.
4	4	CY1-CY4	GRM31BR73A472K	4700p	F	Murata X7R Ceramic Capacitor 1kV or equiv.
5	1	L1	FP3-R47-R	470n	H	Coilcraft Inductor
6	1	C6	08055C391KAT2A	390p	F	Kemet X7R Ceramic Capacitor 50V 0805
7	1	C5	EEU-FC1J101L	100 μ	F	Panasonic Electrolytic Capacitor 63V
8	1	R1	MCR10EZPF9092	90.9k	Ω	Rohm Resistor 0805 1% or equiv.
9	1	R3	MCR10EZPF3013	301k	Ω	Rohm Resistor 0805 1% or equiv.
10	1	R2	MCR10EZPF1003	100k	Ω	Rohm Resistor 0805 1% or equiv.
11	1	R4	MCR10EZPF1000	100	Ω	Rohm Resistor 0805 1% or equiv.
12	1	F1	0154008DR	8	A	Littlefuse Fuseblock 8A SMT
13	8		5015KCT-ND	N/A	N/A	Digi-Key SMT PC Test Point
14	1	OUT	131503100	N/A	N/A	Tektronix Test Jack Assembly
15	6	ENABLE, TRIM_UP, TRIM_DN	TSW-148-07-F-S	N/A	N/A	J,Header 0.1 "

Table 11
PI3110-01-EVAL1
evaluation board BOM

Item	Qty	Ref Design	Part Number	Value	U/M	Description
1	1	U1	PI3110-01-HVIZ	NA	EA	Vicor PI3110-01 High-Density PSiP
2	6	C8-C19	GRM21BR71E-225KA73L	2.2 μ	F	Murata X7R Ceramic Capacitor 25V or equiv.
3	6	C1-C4, C20-C21	12061C105KAT2A	1 μ	F	AVX X7R Ceramic Capacitor 100V or equiv.
4	4	CY1-CY4	GRM31BR73A472K	4700p	F	Murata X7R Ceramic Capacitor 1kV or equiv.
5	1	L1	FP3-4R7-R	4.7 μ	H	Coilcraft Inductor
6	1	C6	08055C391KAT2A	390p	F	Kemet X7R Ceramic Capacitor 50V 0805
7	1	C5	EEU-FC2A470	47 μ	F	Panasonic Electrolytic Capacitor 100V
8	1	R1	MCR10EZPF9092	90.9k	Ω	Rohm Resistor 0805 1% or equiv.
9	1	R3	MCR10EZPF3013	301k	Ω	Rohm Resistor 0805 1% or equiv.
10	1	R2	MCR10EZPF1003	100k	Ω	Rohm Resistor 0805 1% or equiv.
11	1	R4	MCR10EZPF1000	100	Ω	Rohm Resistor 0805 1% or equiv.
12	1	F1	0154003DR	3	A	Littlefuse Fuseblock 3A SMT
13	8		5015KCT-ND	N/A	N/A	Digi-Key SMT PC Test Point
14	1	OUT	131503100	N/A	N/A	Tektronix Test Jack Assembly
15	6	ENABLE, TRIM_UP, TRIM_DN	TSW-148-07-F-S	N/A	N/A	J,Header 0.1"

Table 12
PI3111-00-EVAL1
evaluation board BOM

Item	Qty	Ref Design	Part Number	Value	U/M	Description
1	1	U1	PI3111-00-HVMZ	NA	EA	Vicor PI3111-00 High-Density PSiP
2	6	C8-C19	GRM21BR71E-225KA73L	2.2 μ	F	Murata X7R Ceramic Capacitor 25V or equiv.
3	6	C1-C4, C20-C21	12061C105KAT2A	1 μ	F	AVX X7R Ceramic Capacitor 100V or equiv.
4	4	CY1-CY4	GRM31BR73A472K	4700p	F	Murata X7R Ceramic Capacitor 1kV or equiv.
5	1	L1	FP3-R47-R	470n	H	Coilcraft Inductor
6	1	C6	08055C391KAT2A	390p	F	Kemet X7R Ceramic Capacitor 50V 0805
7	1	C5	EEU-FC1J101L	100 μ	F	Panasonic Electrolytic Capacitor 63V
8	1	R1	MCR10EZPF9092	90.9k	Ω	Rohm Resistor 0805 1% or equiv.
9	1	R3	MCR10EZPF3013	301k	Ω	Rohm Resistor 0805 1% or equiv.
10	1	R2	MCR10EZPF1003	100k	Ω	Rohm Resistor 0805 1% or equiv.
11	1	R4	MCR10EZPF1000	100	Ω	Rohm Resistor 0805 1% or equiv.
12	1	F1	0154008.DR	8	A	Littlefuse Fuseblock 8A SMT
13	8		5015KCT-ND	N/A	N/A	Digi-Key SMT PC Test Point
14	1	OUT	131503100	N/A	N/A	Tektronix Test Jack Assembly
15	6	ENABLE, TRIM_UP, TRIM_DN	TSW-148-07-F-S	N/A	N/A	J,Header 0.1"

Table 13
PI31xx-xx-EVAL1
packing list

Item	Qty	Part Number	U/M	Description
1	1	PI31xx-xx-EVAL1	EA	Evaluation PCB Assembly
2	1	32786	EA	6.3mm Heat sink Assembly
3	1	32784	EA	11mm Heat sink Assembly
4	1	33855	EA	Heat sink Grounding Clip
5	4	32434	EA	Heat sink Pushpins
6	4	N/A	EA	Screw, 6-32
7	4	N/A	EA	Nut, 6-32

Figure 6
PI31xx-xx-EVAL1 test set up

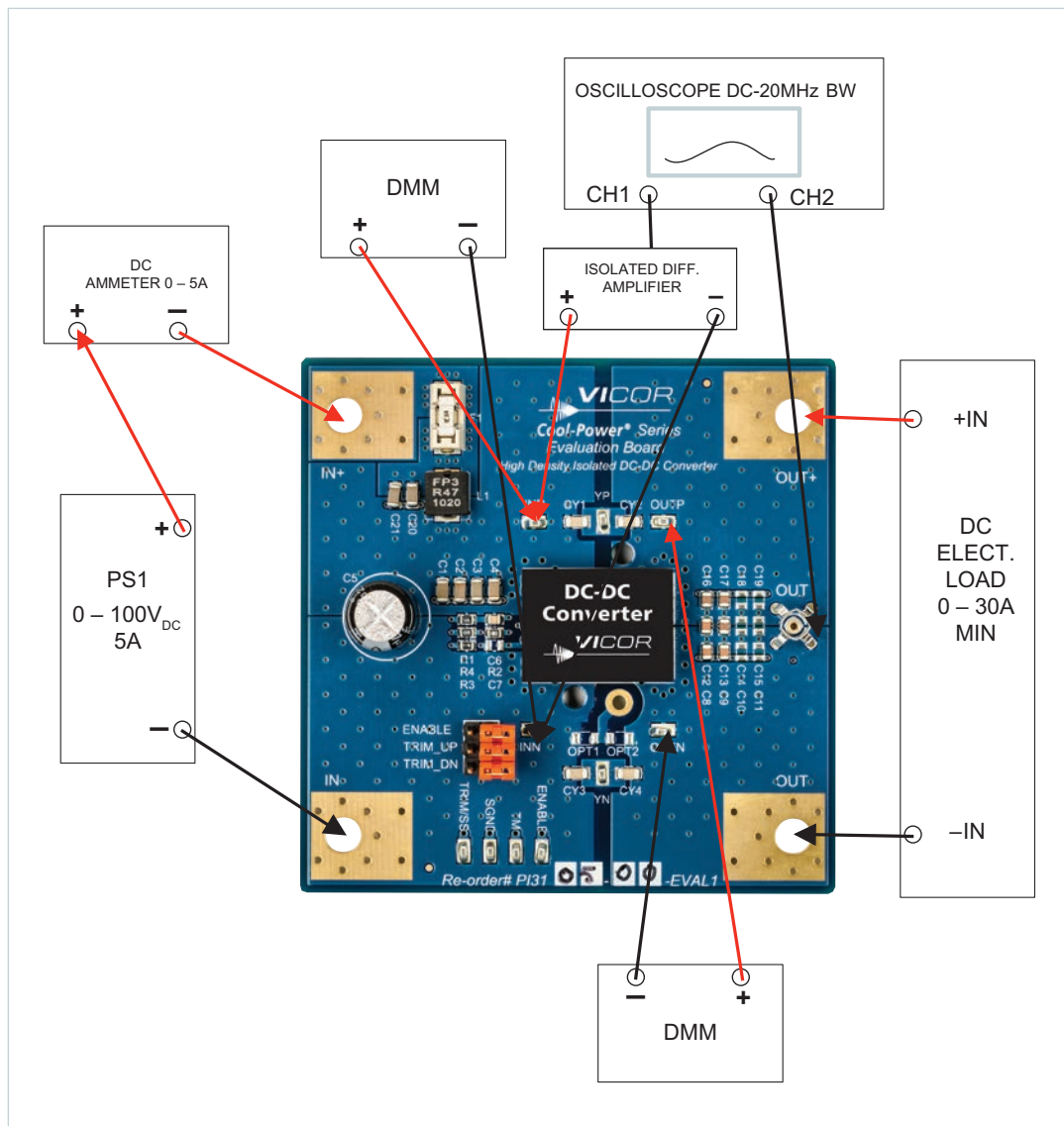

Figure 7
Top-layer artwork
3oz copper

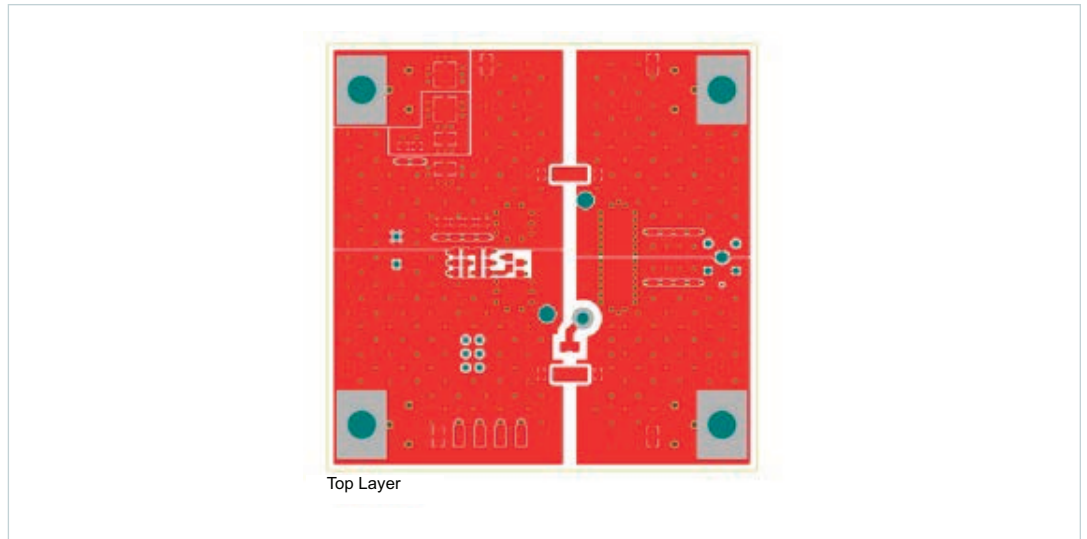

Figure 8
Mid-layer 1 artwork
2oz copper

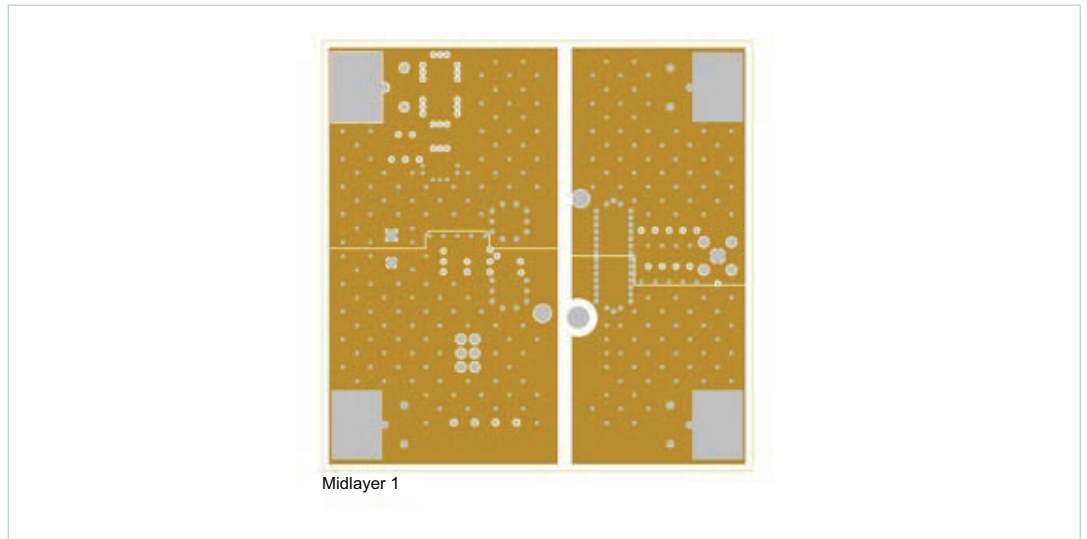

Figure 9
Mid-layer 2 artwork
2oz copper

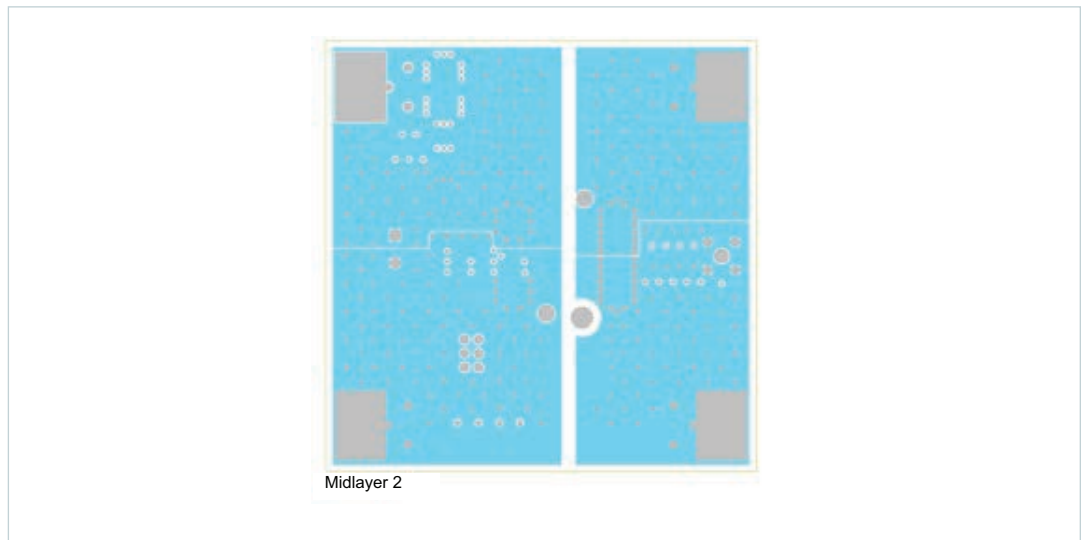

Figure 10
Mid-layer 3 artwork
2oz copper

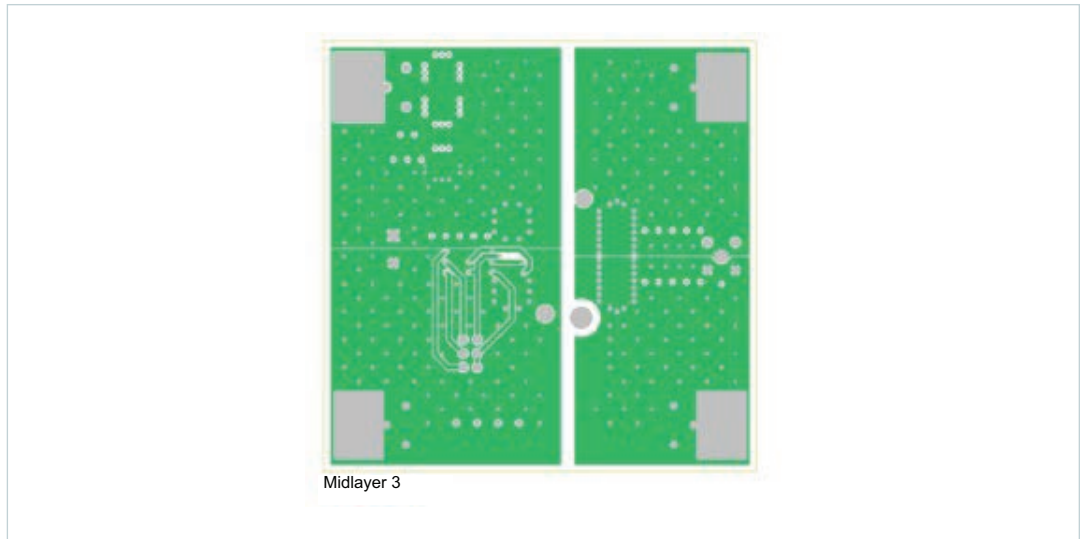

Figure 11
Mid-layer 4 artwork
2oz copper

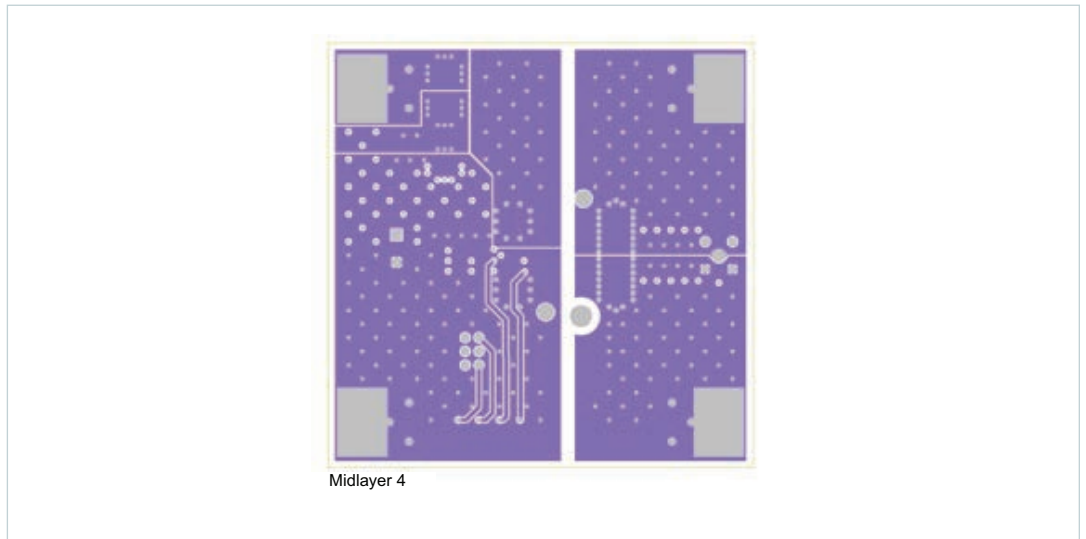

Figure 12
Bottom-layer artwork
3oz copper

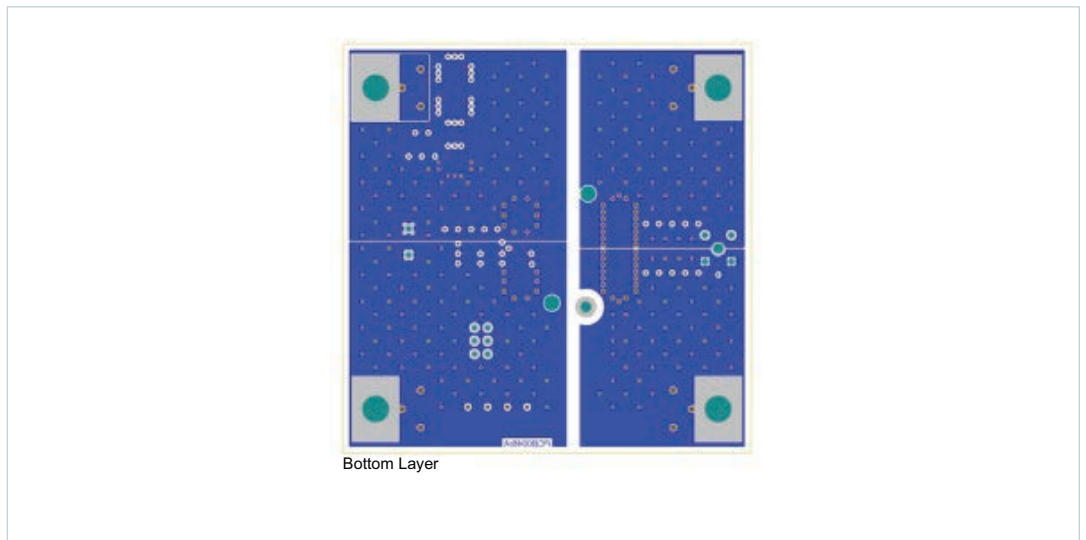
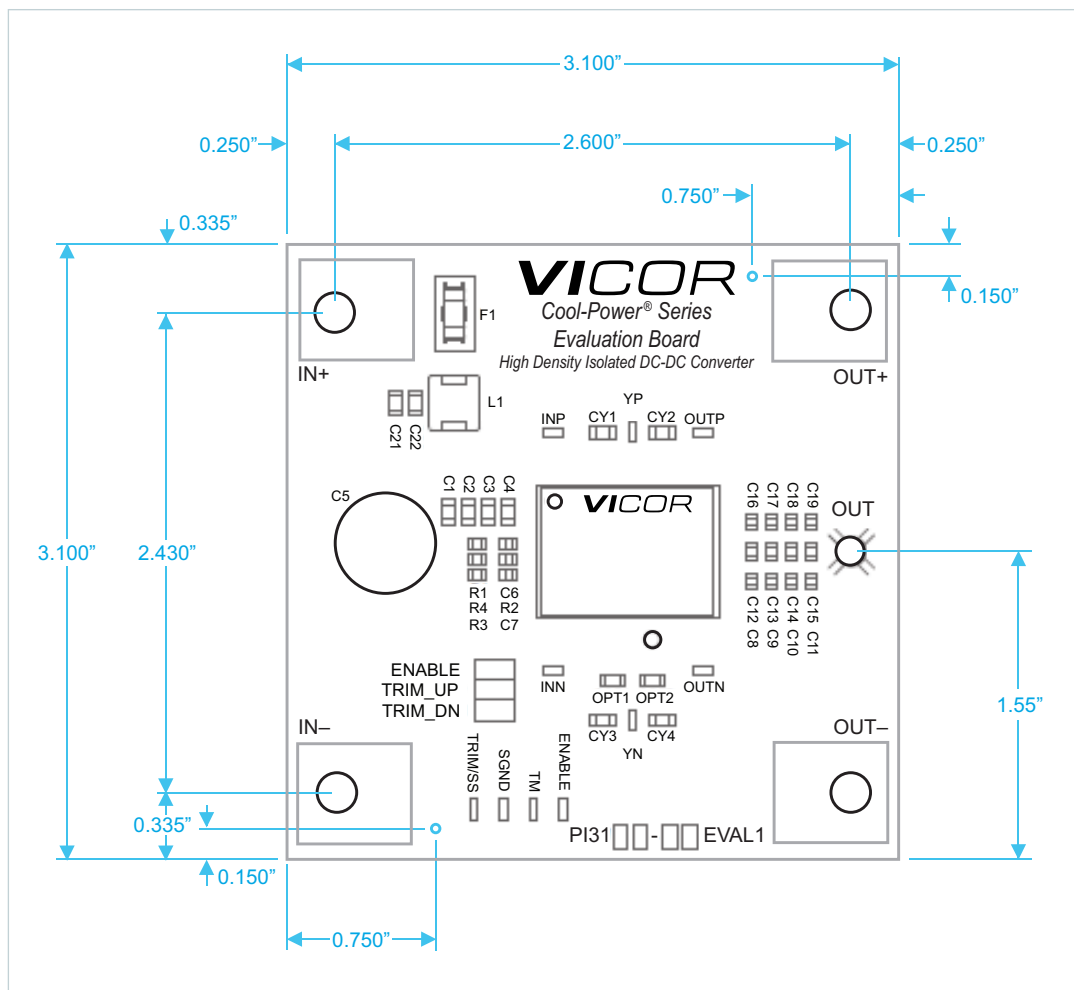

Figure 13
Mechanical drawing



Ordering Information

The PI31xx Customer Evaluation Boards are specified by adding the suffix "-EVAL1" to the base PI31xx-xx model number.

Go to <http://www.vicorpower.com/contact-us> for ordering information.

Limitation of Warranties

Information in this document is believed to be accurate and reliable. HOWEVER, THIS INFORMATION IS PROVIDED "AS IS" AND WITHOUT ANY WARRANTIES, EXPRESSED OR IMPLIED, AS TO THE ACCURACY OR COMPLETENESS OF SUCH INFORMATION. VICOR SHALL HAVE NO LIABILITY FOR THE CONSEQUENCES OF USE OF SUCH INFORMATION. IN NO EVENT SHALL VICOR BE LIABLE FOR ANY INDIRECT, INCIDENTAL, PUNITIVE, SPECIAL OR CONSEQUENTIAL DAMAGES (INCLUDING, WITHOUT LIMITATION, LOST PROFITS OR SAVINGS, BUSINESS INTERRUPTION, COSTS RELATED TO THE REMOVAL OR REPLACEMENT OF ANY PRODUCTS OR REWORK CHARGES).

Vicor reserves the right to make changes to information published in this document, at any time and without notice. You should verify that this document and information is current. This document supersedes and replaces all prior versions of this publication.

All guidance and content herein are for illustrative purposes only. Vicor makes no representation or warranty that the products and/or services described herein will be suitable for the specified use without further testing or modification. You are responsible for the design and operation of your applications and products using Vicor products, and Vicor accepts no liability for any assistance with applications or customer product design. It is your sole responsibility to determine whether the Vicor product is suitable and fit for your applications and products, and to implement adequate design, testing and operating safeguards for your planned application(s) and use(s).

VICOR PRODUCTS ARE NOT DESIGNED, AUTHORIZED OR WARRANTED FOR USE IN LIFE SUPPORT, LIFE-CRITICAL OR SAFETY-CRITICAL SYSTEMS OR EQUIPMENT. VICOR PRODUCTS ARE NOT CERTIFIED TO MEET ISO 13485 FOR USE IN MEDICAL EQUIPMENT NOR ISO/TS16949 FOR USE IN AUTOMOTIVE APPLICATIONS OR OTHER SIMILAR MEDICAL AND AUTOMOTIVE STANDARDS. VICOR DISCLAIMS ANY AND ALL LIABILITY FOR INCLUSION AND/OR USE OF VICOR PRODUCTS IN SUCH EQUIPMENT OR APPLICATIONS AND THEREFORE SUCH INCLUSION AND/OR USE IS AT YOUR OWN RISK.

Terms of Sale

The purchase and sale of Vicor products is subject to the Vicor Corporation Terms and Conditions of Sale which are available at: (<http://www.vicorpower.com/termsconditionswarranty>)

Export Control

This document as well as the item(s) described herein may be subject to export control regulations. Export may require a prior authorization from U.S. export authorities.

Contact Us: <http://www.vicorpower.com/contact-us>

Vicor Corporation
25 Frontage Road
Andover, MA, USA 01810
Tel: 800-735-6200
Fax: 978-475-6715
www.vicorpower.com

email

Customer Service: custserv@vicorpower.com
Technical Support: apps@vicorpower.com

Mouser Electronics

Authorized Distributor

Click to View Pricing, Inventory, Delivery & Lifecycle Information:

[Vicor:](#)

[PI3106-01-EVAL1](#) [PI3106-00-EVAL1](#) [PI3111-00-EVAL1](#) [PI3105-00-EVAL1](#) [PI3101-00-EVAL1](#) [PI3110-01-EVAL1](#)
[PI3109-01-EVAL1](#) [PI3109-00-EVAL1](#) [PI3108-00-EVAL1](#)