

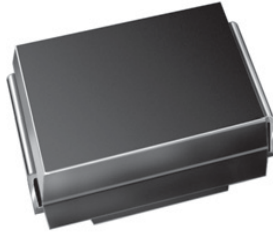

Surface Mount Power Voltage-Regulating Diodes



DO-214AA (SMBJ)

FEATURES

- Low profile package
- Ideal for automated placement
- Low Zener impedance
- Low regulation factor
- Meets MSL level 1, per J-STD-020, if maximum peak of 260 °C
- Material categorization: For definitions of compliance please see www.vishay.com/doc?99912



RoHS
COMPLIANT
HALOGEN
FREE

TYPICAL APPLICATIONS

For general purpose regulation and protection applications.

MECHANICAL DATA

Case: DO-214AA (SMBJ)

Molding compound meets UL 94 V-0 flammability rating
Base P/N-M3 - halogen-free, RoHS-compliant, and commercial grade

Terminals: Matte tin plated leads, solderable per J-STD-002 and JESD22-B102

M3 suffix meets JESD 201 class 1A whisker test

Polarity: Color band denotes cathode end

PRIMARY CHARACTERISTICS	
V _Z	5.6 V to 68 V
P _{tot} at T _L = 75 °C	3000 mW
P _{tot} at T _A = 25 °C	550 mW
T _J max.	150 °C
V _Z specification	Pulse current
Int. construction	Single

MAXIMUM RATINGS (T _A = 25 °C, unless otherwise noted)			
PARAMETER	SYMBOL	VALUE	UNIT
Maximum steady state power dissipation at T _L = 75 °C (fig. 1)	P _{tot}	3000	mW
Maximum steady state power dissipation at T _A = 25 °C (fig. 1)	P _{tot} ⁽¹⁾	550	
Maximum instantaneous forward voltage at 200 mA for all types	V _F ⁽²⁾	1.5	V
Operating junction and storage temperature range	T _J , T _{STG}	- 55 to + 150	°C

Notes

- ⁽¹⁾ Mounted on minimum recommended pad layout
- ⁽²⁾ Pulse test: 300 μs pulse width, 1 % duty cycle

ELECTRICAL CHARACTERISTICS	
SYMBOL	PARAMETER
V_Z	Reverse Zener voltage at I_{ZT}
I_{ZT}	Reverse current
Z_{ZT}	Maximum Zener impedance at I_{ZT}
I_{ZK}	Reverse current
Z_{ZK}	Maximum Zener impedance at I_{ZK}
I_R	Reverse leakage current at V_R
V_R	Reverse voltage
I_F	Forward current
V_F	Forward voltage at I_F
I_{ZM}	Maximum DC Zener current

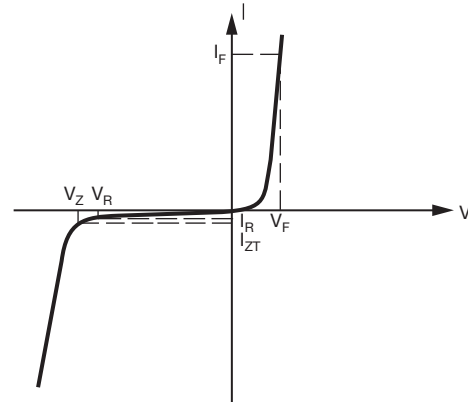

Zener Voltage Regulator

ELECTRICAL CHARACTERISTICS ($T_A = 25^\circ\text{C}$ unless otherwise noted)											
PART NUMBER	DEVICE MARKING CODE	ZENER VOLTAGE RANGE			TEST CURRENT		MAXIMUM ZENER IMPEDANCE		REVERSE LEAKAGE CURRENT		MAXIMUM ZENER CURRENT
		V_Z AT I_{ZT}			I_{ZT}	I_{ZK}	Z_{ZT} AT I_{ZT}	Z_{ZK} AT I_{ZK}	I_R AT V_R		I_{ZM}
		V			mA		Ω		μA	V	mA
		MIN.	NOM.	MAX.			MAX.	MAX.	MAX.		MAX.
SMBZ5919B	19B	5.32	5.6	5.88	66.9	1	5	700	200	3	267
SMBZ5920B	20B	5.89	6.2	6.51	60.5	1	2	700	200	4	241
SMBZ5921B	21B	6.46	6.8	7.14	55.1	1	2.5	400	200	5.2	220
SMBZ5924B	24B	8.64	9.1	9.56	41.2	0.5	4.0	1000	25	7.0	164
SMBZ5925B	25B	9.5	10	10.5	37.5	0.25	4.5	1000	25	8.0	150
SMBZ5926B	26B	10.5	11	11.6	34.1	0.25	5.5	550	5	8.4	136
SMBZ5927B	27B	11.4	12	12.6	31.2	0.25	6.5	550	1	9.1	125
SMBZ5928B	28B	12.4	13	13.7	28.8	0.25	7.0	550	1	9.9	115
SMBZ5929B	29B	14.3	15	15.8	25.0	0.25	9.0	600	1	11.4	100
SMBZ5930B	30B	15.2	16	16.8	23.4	0.25	10.0	600	1	12.2	93
SMBZ5931B	31B	17.1	18	18.9	20.8	0.25	12.0	650	1	13.7	83
SMBZ5932B	32B	19.0	20	21.0	18.7	0.25	14.0	650	1	15.2	75
SMBZ5933B	33B	20.9	22	23.1	17.0	0.25	17.5	650	1	16.7	68
SMBZ5934B	34B	22.8	24	25.2	15.6	0.25	19.0	700	1	18.2	62
SMBZ5935B	35B	25.7	27	28.4	13.9	0.25	23.0	700	1	20.6	55
SMBZ5936B	36B	28.5	30	31.5	12.5	0.25	28.0	750	1	22.8	50
SMBZ5937B	37B	31.4	33	34.7	11.4	0.25	33.0	800	1	25.1	45
SMBZ5938B	38B	34.2	36	37.8	10.4	0.25	38.0	850	1	27.4	41
SMBZ5939B	39B	37.1	39	41.0	9.6	0.25	45.0	900	1	29.7	38
SMBZ5940B	40B	40.9	43	45.2	8.7	0.25	53.0	950	1	32.7	34
SMBZ5941B	41B	44.6	47	49.4	8.0	0.25	67	1000	1	35.8	31
SMBZ5942B	42B	48.4	51	53.6	7.3	0.25	70	1100	1	38.8	29
SMBZ5943B	43B	53.2	56	58.8	6.7	0.25	86	1300	1	42.6	26
SMBZ5944B	44B	58.9	62	65.1	6.0	0.25	100	1500	1	47.1	24
SMBZ5945B	45B	64.6	68	71.4	5.5	0.25	120	1700	1	51.7	22



THERMAL CHARACTERISTICS ($T_A = 25\text{ }^\circ\text{C}$ unless otherwise noted)			
PARAMETER	SYMBOL	VALUE	UNIT
Typical thermal resistance, junction to lead	$R_{\theta JL}$	25	$^\circ\text{C/W}$
Typical thermal resistance, junction to ambient	$R_{\theta JA}^{(1)}$	226	$^\circ\text{C/W}$

Note

(1) Mounted on minimum recommended pad layout

ORDERING INFORMATION (Example)				
PREFERRED P/N	UNIT WEIGHT (g)	PREFERRED PACKAGE CODE	BASE QUANTITY	DELIVERY MODE
SMBZ5935B-M3/52	0.096	52	750	7" diameter plastic tape and reel
SMAZ5935B-M3/5B	0.096	5B	3200	13" diameter plastic tape and reel

RATINGS AND CHARACTERISTICS CURVES ($T_A = 25\text{ }^\circ\text{C}$ unless otherwise noted)

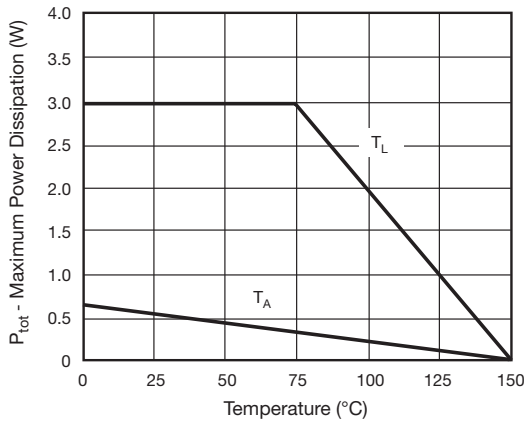

Fig. 1 - Steady State Power During

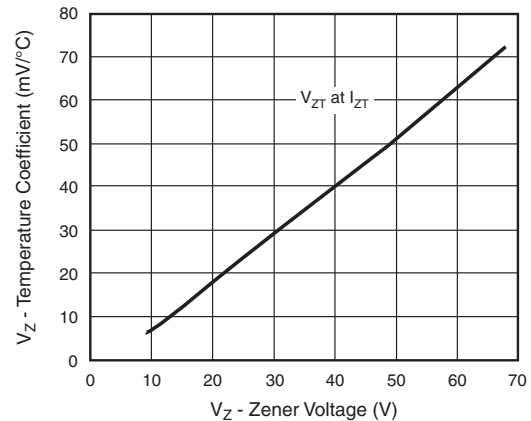

Fig. 3 - Typical Temperature Coefficients

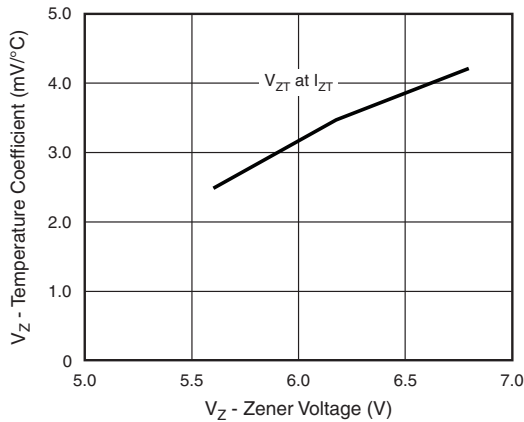

Fig. 2 - Typical Temperature Coefficients

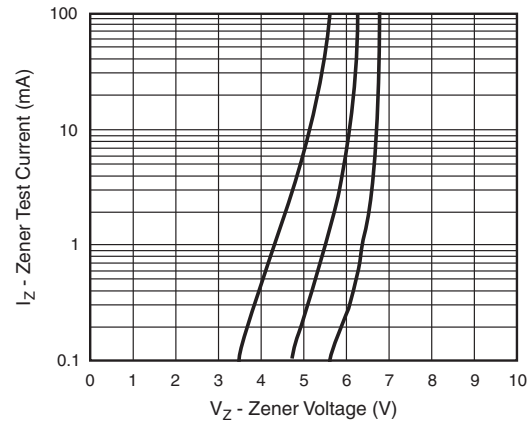

Fig. 4 - Typical Zener Voltage

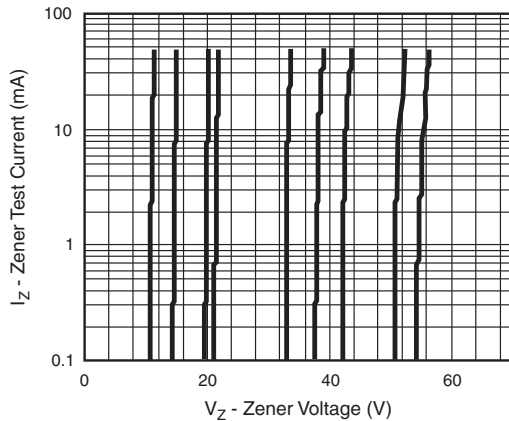

Fig. 5 - Typical Zener Voltage

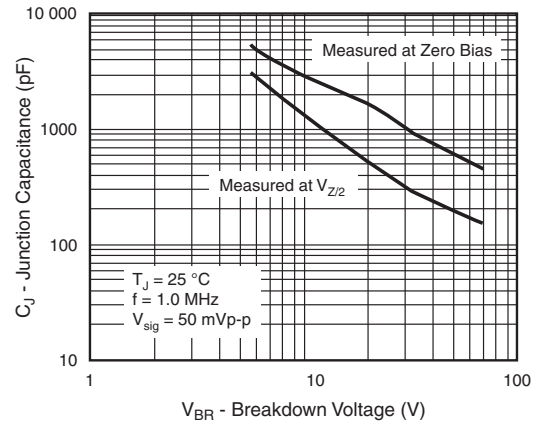

Fig. 7 - Typical Junction Capacitance

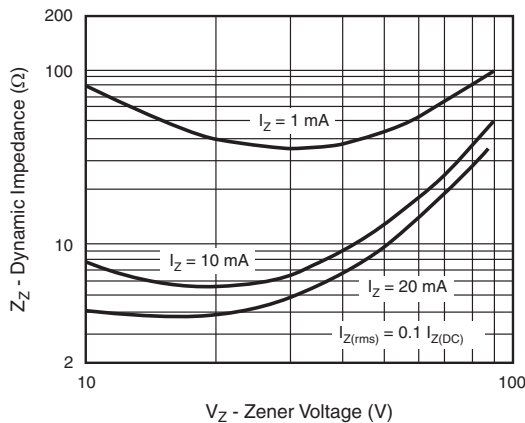
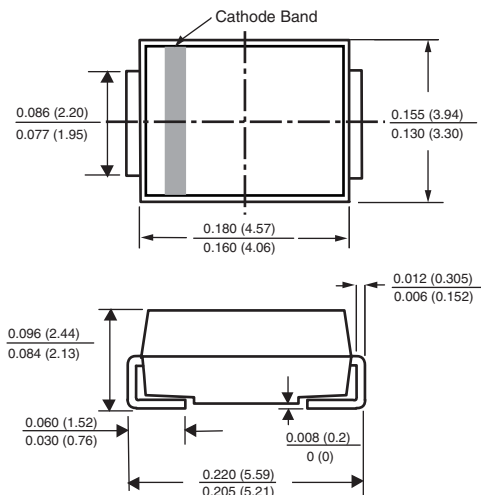

Fig. 6 - Typical Zener Impedance

PACKAGE OUTLINE DIMENSIONS in inches (millimeters)

DO-214AA (SMB-J-Bend)



Mounting Pad Layout

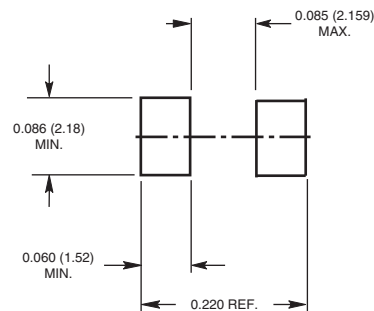



Disclaimer

ALL PRODUCT, PRODUCT SPECIFICATIONS AND DATA ARE SUBJECT TO CHANGE WITHOUT NOTICE TO IMPROVE RELIABILITY, FUNCTION OR DESIGN OR OTHERWISE.

Vishay Intertechnology, Inc., its affiliates, agents, and employees, and all persons acting on its or their behalf (collectively, "Vishay"), disclaim any and all liability for any errors, inaccuracies or incompleteness contained in any datasheet or in any other disclosure relating to any product.

Vishay makes no warranty, representation or guarantee regarding the suitability of the products for any particular purpose or the continuing production of any product. To the maximum extent permitted by applicable law, Vishay disclaims (i) any and all liability arising out of the application or use of any product, (ii) any and all liability, including without limitation special, consequential or incidental damages, and (iii) any and all implied warranties, including warranties of fitness for particular purpose, non-infringement and merchantability.

Statements regarding the suitability of products for certain types of applications are based on Vishay's knowledge of typical requirements that are often placed on Vishay products in generic applications. Such statements are not binding statements about the suitability of products for a particular application. It is the customer's responsibility to validate that a particular product with the properties described in the product specification is suitable for use in a particular application. Parameters provided in datasheets and / or specifications may vary in different applications and performance may vary over time. All operating parameters, including typical parameters, must be validated for each customer application by the customer's technical experts. Product specifications do not expand or otherwise modify Vishay's terms and conditions of purchase, including but not limited to the warranty expressed therein.

Except as expressly indicated in writing, Vishay products are not designed for use in medical, life-saving, or life-sustaining applications or for any other application in which the failure of the Vishay product could result in personal injury or death. Customers using or selling Vishay products not expressly indicated for use in such applications do so at their own risk. Please contact authorized Vishay personnel to obtain written terms and conditions regarding products designed for such applications.

No license, express or implied, by estoppel or otherwise, to any intellectual property rights is granted by this document or by any conduct of Vishay. Product names and markings noted herein may be trademarks of their respective owners.