

Ceramic Capacitors (Safety Regulations) For Surface Mounting Types

Discontinued

- Type HC (Sub-Class Y1)
- Type FC (Sub-Class Y2)
- Type BC (Sub-Class Y2)



■ Features

- Resin molded SMD type for flow/reflow soldering (HC) and reflow soldering (FC,BC)
- High reliability
- Safety requirement approved by UL, SEMKO, NEMKO, FIMKO, DEMKO and KTL* * KTL: only Type FC

■ Recommended Application

- Interference suppressors circuit and Isolation circuit of IT equipment such as MODEM.
- Interference suppressors circuit of small power supply machinery such as DC-DC converters and power modules.
- Interference suppressors circuit of AC primary side for general electronic equipment.

■ Explanation of Part Numbers

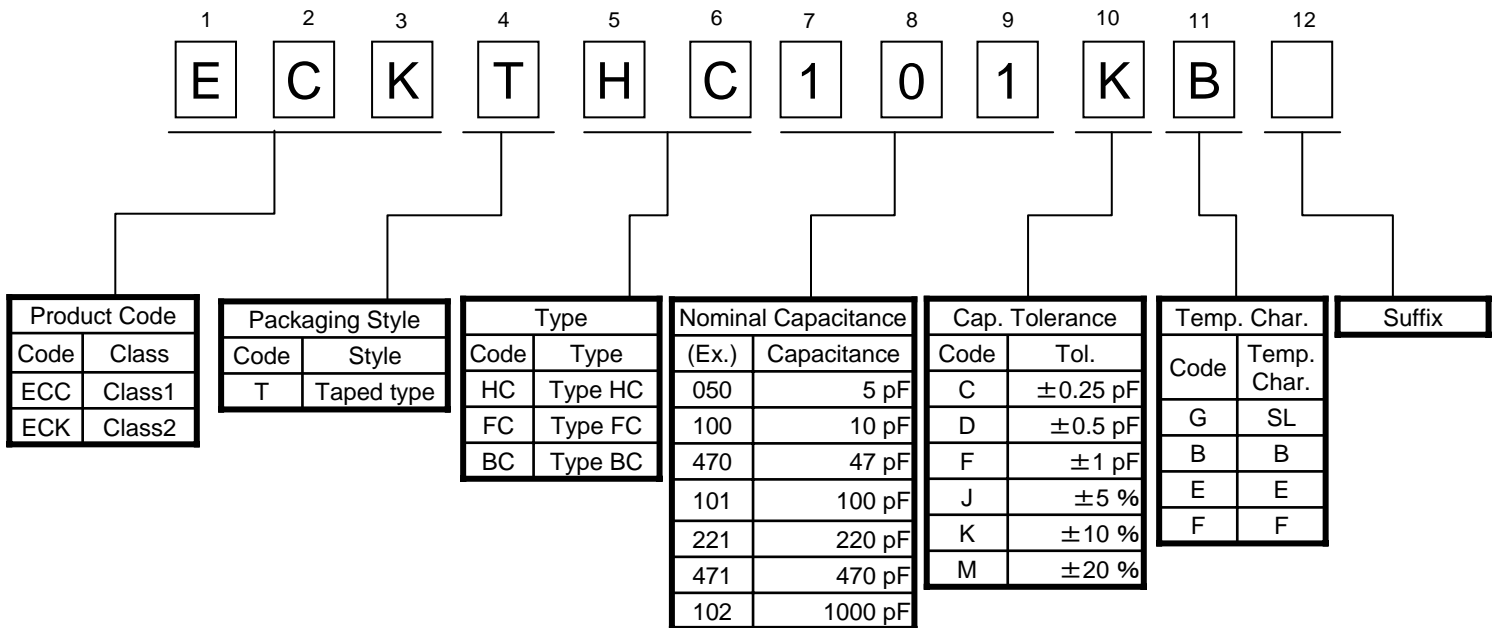

■ Construction

- Type HC

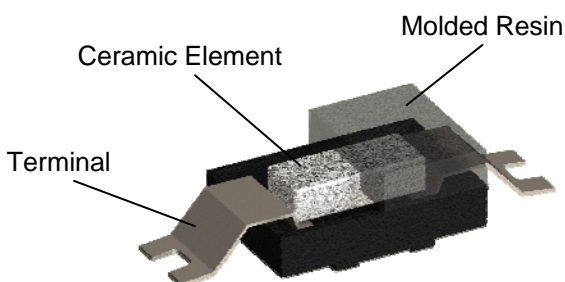

- Type FC,BC

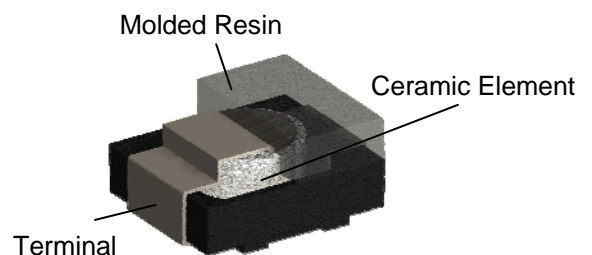

■ Dimensions in mm (not to scale) 【Type HC:Y1】

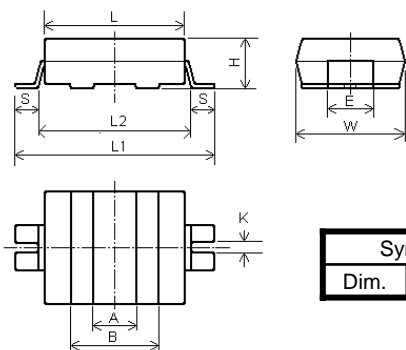

Symbol	L	W	H	S	E	A	B	L1	L2
Dim. Type HC	6.8±0.3	4.5±0.2	2.5 max	1.0±0.50	2.5±0.2	(1.7)	(3.1)	12.0±0.5	8.0 min

■ Specifications 【Type HC:Y1】

Characteristics	Temp. Char. B/Y5P		
Operating Temperature Range	-25 to 125 °C		
Rated Voltage	250 VAC		
Dielectric Withstanding Voltage	4000 VAC for 1 minute		
Capacitance	Within the specified tolerance, when measured at 1kHz±20%, 1 to 5 Vrms. and 20 °C		
Q or Dissipation Factor (tan δ)	tan δ < 0.025 at 1 kHz±20 %, 1 to 5 Vrms. and 20 °C		
Insulation Resistance	10000 MΩ min. at 500 VDC and 1 minute electrification		
Temperature Characteristics	Char.	Max. Cap. Change	Temp. Range
	B/Y5P	±10%	-25 ~ 85 °C

■ Dimensions in mm (not to scale) 【Type BC,FC:Y2】

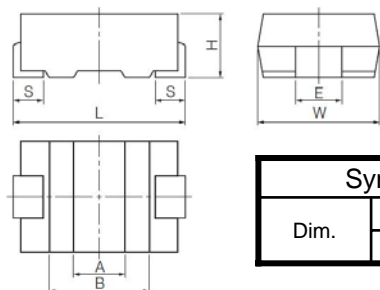

Symbol	L	W	H	S	E	A	B
Dim.	Type FC	5.7±0.5	4.5±0.3	2.3 max	0.85±0.30	2.5±0.2	(1.7) (3.1)
	Type BC	7.1±0.5	6.3±0.3	2.5±0.3	1.45±0.30	2.5±0.2	(2.0) (3.7)

■ Specifications 【Type BC,FC:Y2】

Characteristics	Temp. Char. SL/GP	Temp. Char. B/Y5P, E/Y5U, F/Y5V		
Operating Temperature Range	-25 to 100 °C			
Rated Voltage	250 VAC			
Dielectric Withstanding Voltage	1500 VAC for 1 minute			
Capacitance	Within the specified tolerance, when measured at 1 MHz±20 %, 1 to 5 Vrms. and 20 °C	Within the specified tolerance, when measured at 1 kHz±20 %, 1 to 5 Vrms. and 20 °C		
Q or Dissipation Factor (tan δ)	30 pF or under Q > 200+10 C (C:Cap.pF) over 30 pF Q > 500 at 1 MHz±20 %, 1 to 5 Vrms. and 20 °C	tan δ < 0.025 at 1 kHz±20 %, 1 to 5 Vrms. and 20 °C		
Insulation Resistance	10000 MΩ min. at 500 VDC and 1 minute electrification			
Temperature Characteristics	Temperature Coefficient:+350 to -1000 ppm/ °C over the temperature range 20 to 85 °C	Char.	Max. Cap. Change	Temp. Range
		B/Y5P	±10%	-25 ~ 85 °C
		E/Y5U	+20,-55%	
		F/Y5V	+30,-80%	

■ Related Standards and Certificate Number

Certification Body	Related Standard	Certificate Number			Sub-Class	Rated Voltage	Dielectric Withstanding Voltage	Operating Temperature Range
		Type HC	Type FC	Type BC				
UL(USA)	UL60384-14	E62674	E62674	E62674	HC:Y1 BC/FC:Y2	250 VAC	HC: 4000 VAC BC/FC: 1500 VAC	HC: -25 ~ 125°C BC/FC: -25 ~ 100°C
	CAN/CSA –E60384-14	-----	-----	E62674	Y2		1500 VAC	
SEMKO(Sweden)	EN60384-14 2005	1025027	806189	1025267	HC:Y1 BC/FC:Y2	250 VAC	HC: 4000 VAC BC/FC: 1500 VAC	
FIMKO(Finland)		FI 26683	FI 16588A1 FI 17348A2	FI 26770				
DEMKO(Denmark)		D-00043	310914-01 310698-01	Issuing certification now				
NEMKO(Norway)		P11213874	P01100665 P01101830	P11214054				
KTL(Korea)		K60384-14	-----	SU03013- 3001				

■ Ratings and Characteristics

Type Name	Part Number	Capacitance (pF)	Cap. Tolerance	Temp. Char	Dimensions in mm
Type HC	ECKTHC101KB	100	±10 %	B/Y5P	6.8L × 4.5W × 2.5H
	ECKTHC221KB	220			
	ECKTHC471KB	470			
	ECKTHC101MB	100	±20 %		
	ECKTHC221MB	220			
	ECKTHC471MB	470			
Type FC	ECCTFC100DG	10	±0.5 pF	SL/GP	5.7L × 4.5W × 2.3H
	ECCTFC150JG	15	±5 %		
	ECCTFC220JG	22			
	ECCTFC330JG	33	±10 %	B/Y5P	
	ECKTFC470KB	47			
	ECKTFC101KB	100			
	ECKTFC151KB	150			
	ECKTFC221KB	220			
	ECKTFC331KB	330			
	ECKTFC471KB	470	±20 %	E/Y5U	
	ECKTFC102ME	1000		F/Y5V	
	ECKTFC152MF	1500			
	ECKTFC222MF	2200			
Type BC	ECCTBC100DG	10	±0.5 pF	SL/GP	7.1L × 6.3W × 2.5H
	ECCTBC150JG	15	±5 %		
	ECCTBC220JG	22			
	ECCTBC330JG	33			
	ECCTBC470JG	47			
	ECCTBC680JG	68			
	ECKTBC101KB	100		±10 %	
	ECKTBC151KB	150			
	ECKTBC221KB	220			
	ECKTBC331KB	330			
	ECKTBC471KB	470			
	ECKTBC681KB	680			
	ECKTBC102ME	1000	±20 %	E/Y5U	
	ECKTBC152ME	1500			
	ECKTBC222ME	2200			

Notes * Other capacitance values are available by special order.

■ Packaging Methods (Taping)

● Minimum Quantity/Packing Unit

Type	Packaging style	Part Number		Minimum Packing Quantity	Packing Quantity in Carton	Carton Dimensions in mm (LWH)
Type HC	Embossed Carrier Taping	EC□□THC□□□□□□	100~470pF	3000 pcs./reel	6000 pcs	350 × 350 × 62
Type FC	Embossed Carrier Taping	EC□□TFC□□□□□□	10 to 2200pF	3000 pcs./reel	9000 pcs.	350 × 350 × 62
Type BC	Embossed Carrier Taping	EC□□TBC□□□□□□	10 to 2200pF	2000 pcs./reel	6000 pcs.	350 × 350 × 62

● Reel

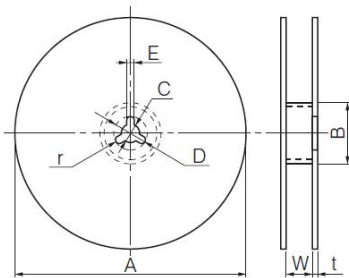

Symbol		A	B	C	D	E	W	t	r
Dim. (mm)	Type HC	330 ±5	60 min	13.0 ±0.5	21.0 ±1.0	2.0 ±0.5	25.5 ±1.5	2.0 ±0.5	R1.0
	Type FC						13.5 ±1.5		
	Type BC								

● Embossed carrier taping

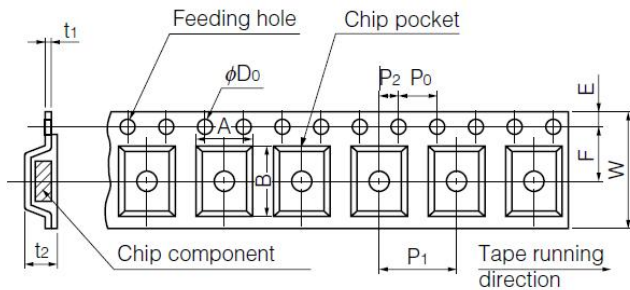

Symbol		A	B	W	F	E	P ₁	P ₂	P ₀	φD ₀	t ₁	t ₂
Dim. (mm)	Type HC	4.8 ±0.2	12.3 ±0.2	24.0 ±0.3	11.5 ±0.1	1.75 ±0.10	8.0 ±0.1	2.00 ±0.05	4.1 ±0.1	1.5 +0.1 -0	0.3 ±0.1	2.8 ±0.3
	Type FC		6.0 ±0.2	12.0 ±0.3	5.5 ±0.1							3.2 ±0.3
	Type BC	6.5 ±0.2	7.5 ±0.2									

● Leader Part and Taped End

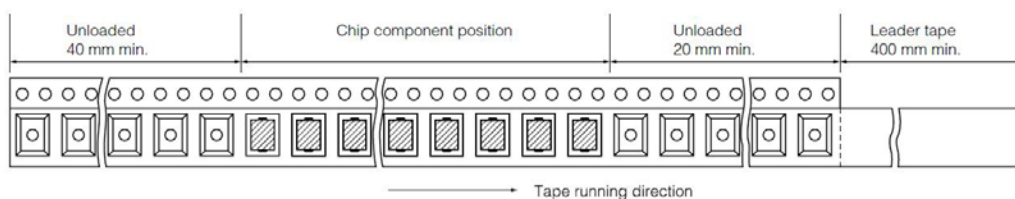

■ Typical Characteristics

● Temperature Characteristics

Char. SL/GP
(Temp.Coeff.: +350 to -1000 ppm/°C)

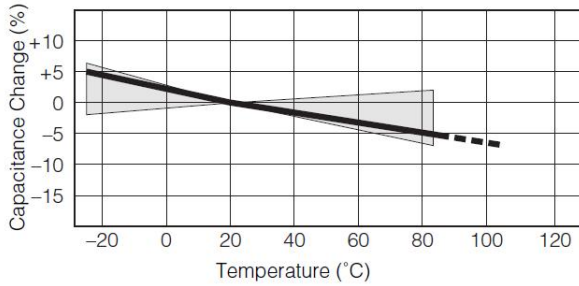

Char. B/Y5P
Temp.Range: -25 to 85 °C
Max.Cap.Change: ± 10 %

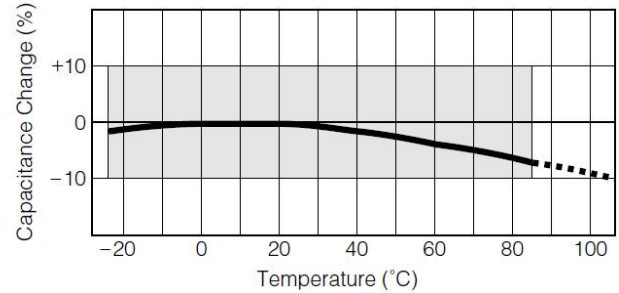

Char. E/Y5U (Temp.Range: -25 to 85 °C
max.Cap.Change: +20, -55 %)

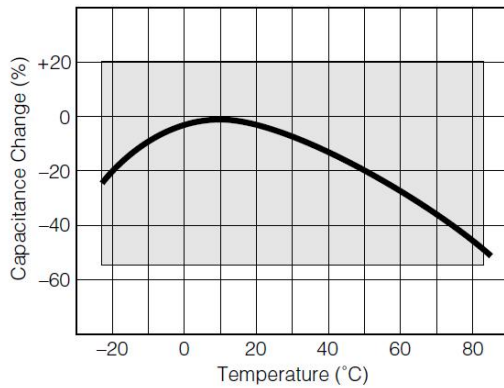

Char. F/Y5V (Temp. Range : -25 to 85 °C
max.Cap.Change: +30, -80 %)

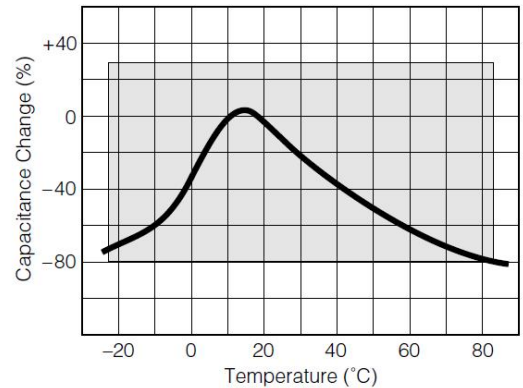

● Impedance vs. Frequency Characteristics

Type FC

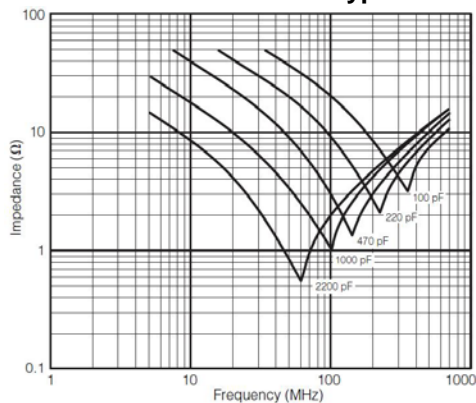

Type BC

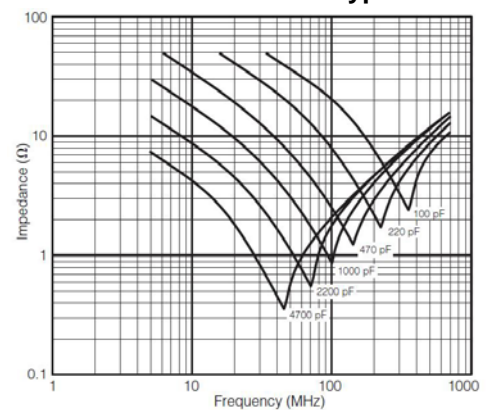

■ Typical Characteristics

● Current vs. Voltage (Leakage Current Characteristics)

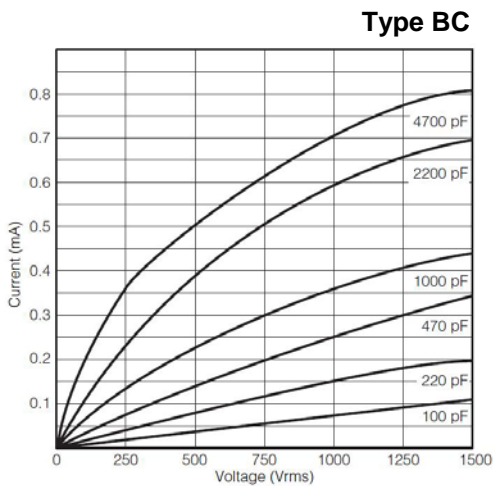
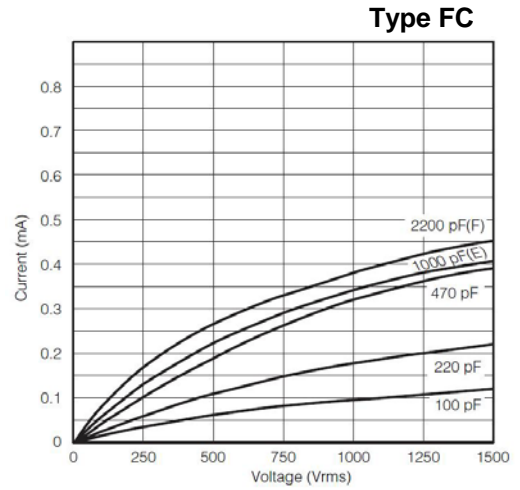
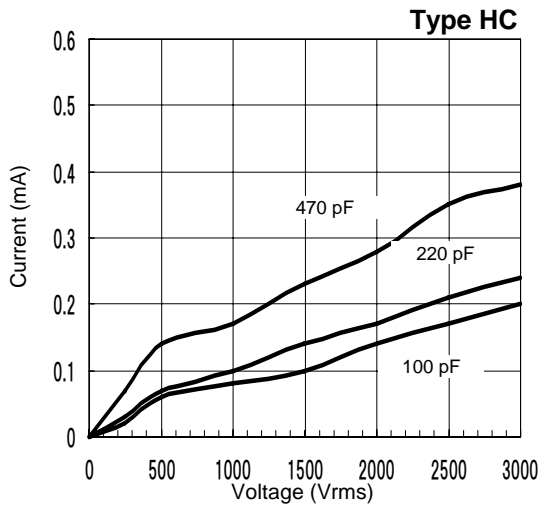

■ Application Examples

● MODEM

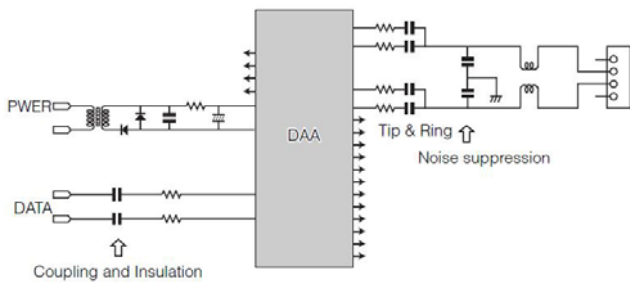

● Primary circuit of Switching Power Supply

