

SMD Power Inductor CDRH12D58R



Description

- Ferrite drum core construction.
- Magnetically shielded.
- L × W × H: 12.4 × 12.4 × 6.0 mm Max.
- Product weight: 2.9 g(Ref.)
- Moisture Sensitivity Level: 1
- RoHS compliance.

Environmental Data

- Operating temperature range: -40°C~+105°C
- Storage temperature range: -40°C~+105°C
- Solder reflow temperature: 260 °C peak.

Packaging

- Carrier tape and reel packaging
- 11.8" diameter reel
- 500pcs per reel

Applications

- Ideally used in Game machine, Notebook PC, LCD TV, DVD, STB, Projector etc as DC-DC converter inductors.

Dimension - [mm]

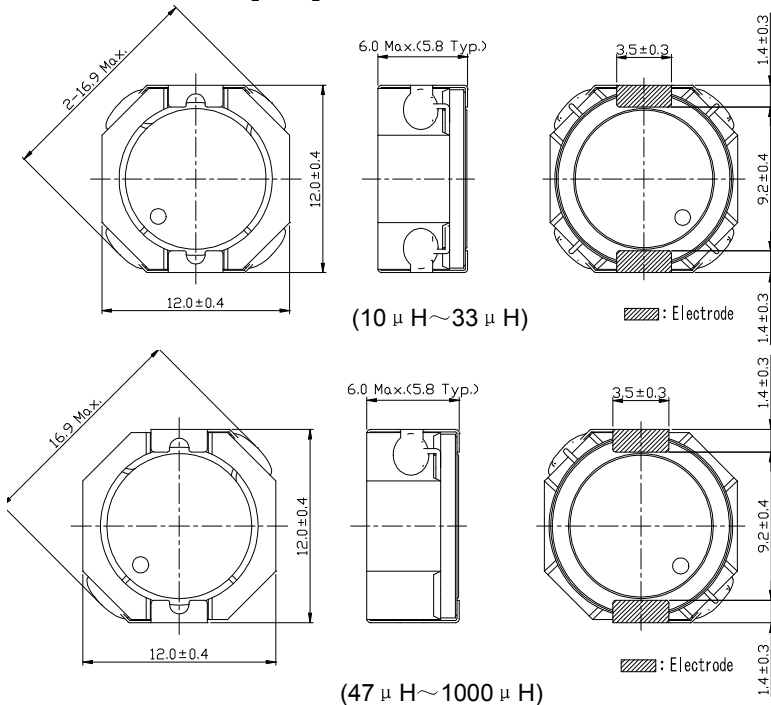

Land pattern and Schematics - [mm]

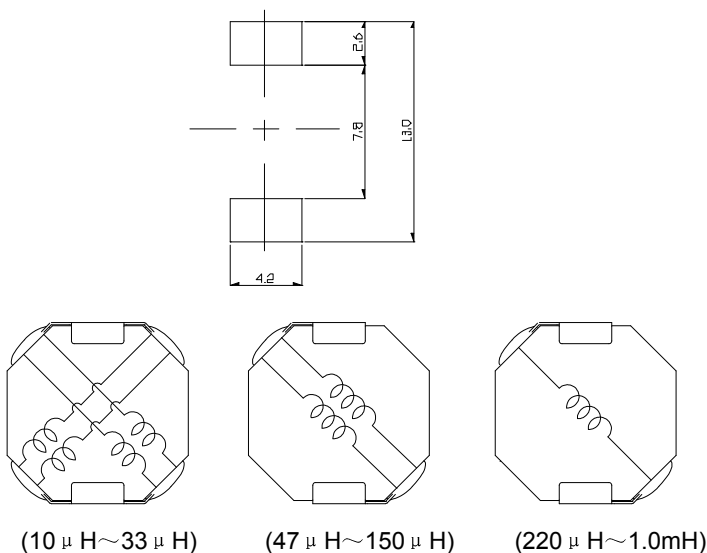

SMD Power Inductor CDRH12D58R



Electrical Characteristics

Part Name	Stamp	Inductance (μ H) [within] ※1	D.C.R. ($m\Omega$) Max. (Typ.) (at 20°C)	Saturation Current (A) ※2		Temperature Rise Current (A) ※3
				at 20°C	at 105°C	
CDRH12D58RNP-100MC	100	10 \pm 20%	22.5(18)	7.20	4.70	4.70
CDRH12D58RNP-150MC	150	15 \pm 20%	28.8(23)	5.50	3.60	4.60
CDRH12D58RNP-220MC	220	22 \pm 20%	42.5(34)	4.70	3.10	3.30
CDRH12D58RNP-330MC	330	33 \pm 20%	53.8(43)	3.70	2.40	2.95
CDRH12D58RNP-470MC	470	47 \pm 20%	86.5(69)	3.15	2.10	2.10
CDRH12D58RNP-680MC	680	68 \pm 20%	121(97)	2.65	1.75	1.86
CDRH12D58RNP-101MC	101	100 \pm 20%	176(141)	2.25	1.5	1.56
CDRH12D58RNP-151MC	151	150 \pm 20%	251(201)	1.80	1.20	1.28
CDRH12D58RNP-221MC	221	220 \pm 20%	391(313)	1.45	1.00	1.03
CDRH12D58RNP-331MC	331	330 \pm 20%	544(435)	1.22	0.80	0.90
CDRH12D58RNP-471MC	471	470 \pm 20%	764(611)	1.01	0.66	0.68
CDRH12D58RNP-681MC	681	680 \pm 20%	1078(863)	0.86	0.56	0.61
CDRH12D58RNP-102MC	102	1000 \pm 20%	1625(1300)	0.69	0.46	0.48

※1. Inductance measuring condition :at 100kHz

※2. Saturation current: The value of D.C. current when the inductance decreases to 65% of it's nominal value.

※3. Temperature rise current: The value of D.C. current when the temperature rise is $\Delta t=40^{\circ}\text{C}$ ($T_a=20^{\circ}\text{C}$).

SMD Power Inductor CDRH12D58R



Saturation Current & Temperature Rise Graph

— L (20°C) — L (100°C) — ΔT

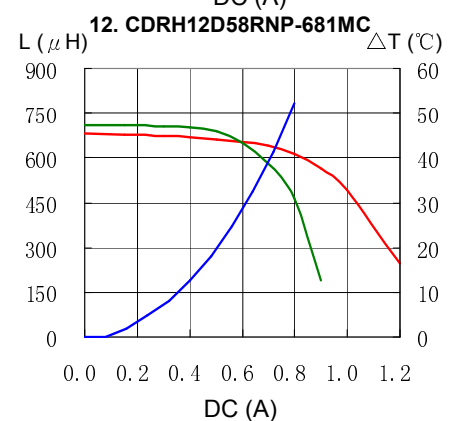
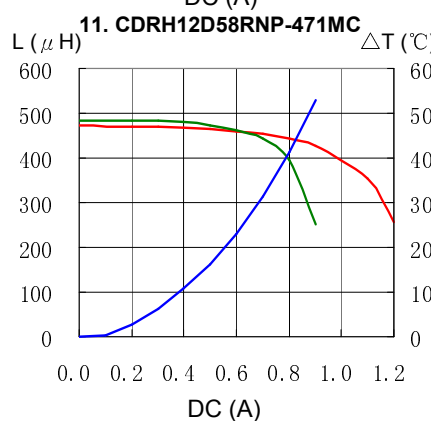
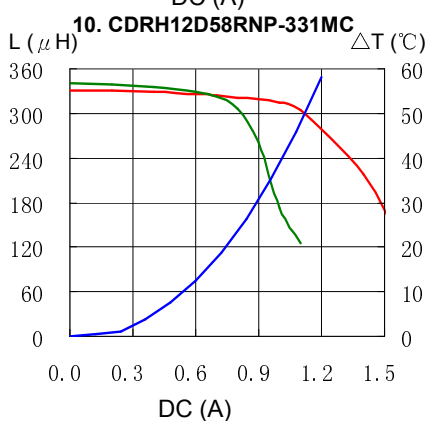
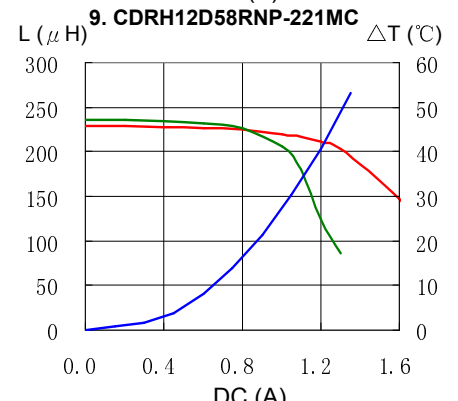
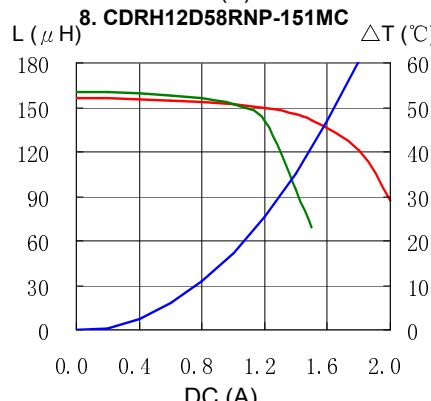
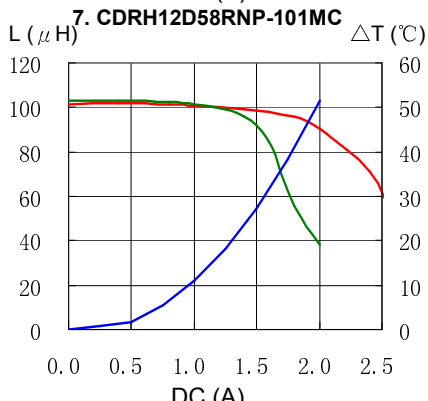
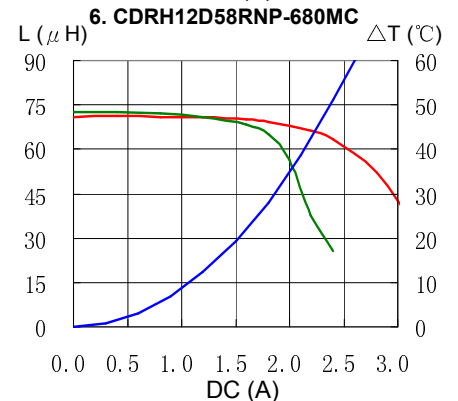
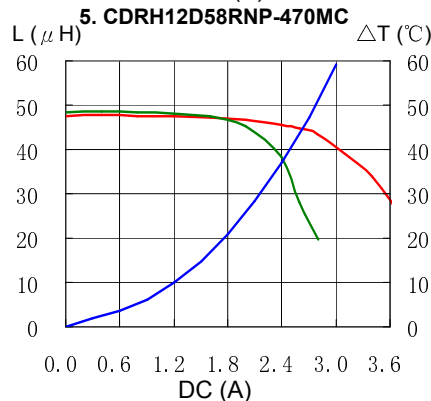
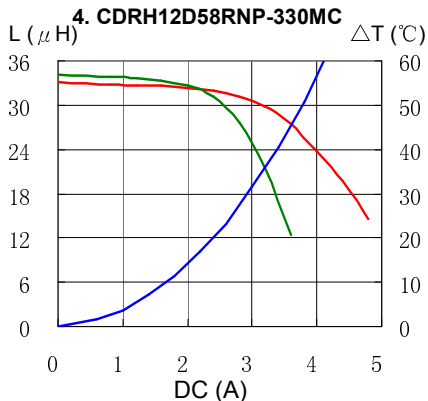
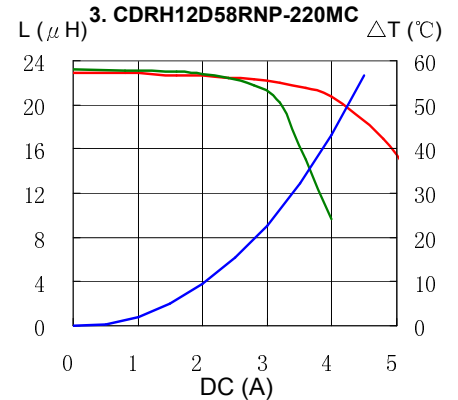
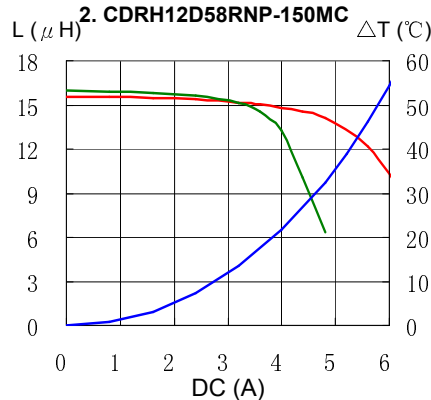
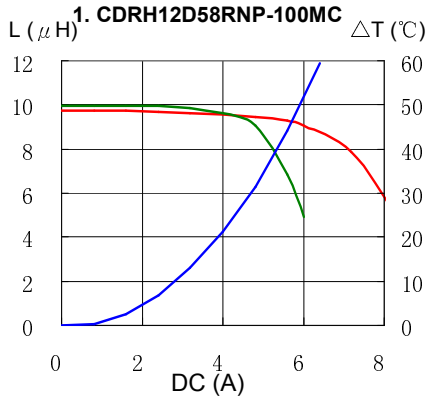

SMD Power Inductor CDRH12D58R



Saturation Current & Temperature Rise Graph

— L (20°C) — L (100°C) — ΔT

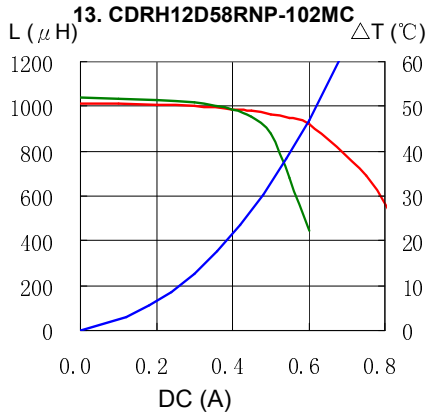

Solder Reflow Condition

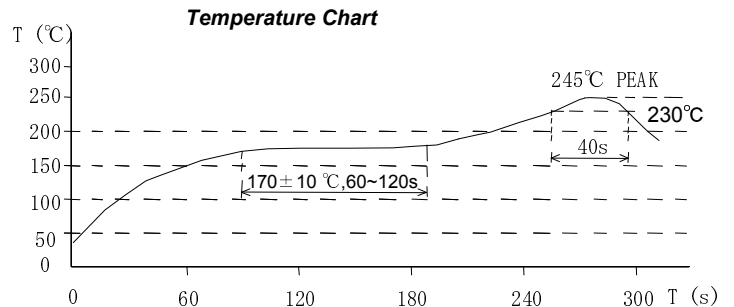
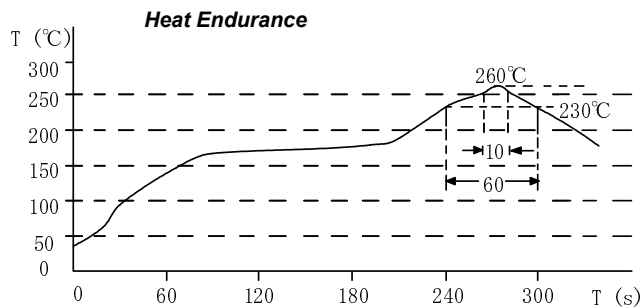

Please refer to the sales offices on our website - <http://www.sumida.com>

Hong Kong
Tel.+852-2880-6781
FAX.+852-2565-9600
sales@hk.sumida.com

Saitama(Japan)
Tel.+81-48-691-7300
FAX.+81-48-691-7340
sales@jp.sumida.com

Chicago
Tel.+1-847-545-6700
FAX. +1-847-545-6720
sales@us.sumida.com

Shanghai
Tel.+86-21-5836-3299
FAX.+86-21-5836-3266
shanghai.sales@cn.sumida.com

Seoul
Tel.+82-2-6237-0777
FAX.+82-2-6237-0778
sales@kr.sumida.com

Oberzell
Tel.+49-8591-937-0
FAX. +49-8591-937-103
contact@eu.sumida.com

Shenzhen
Tel.+86-755-8291-0228
FAX.+86-755-8291-0338
shenzhen.sales@cn.sumida.com

Singapore
Tel.+65-6296-3388
FAX.+65-6841-4426
sales@sg.sumida.com

Neumarkt
Tel.+49-9181-4509-110
FAX. +49-9181-4509-310
infocomp@eu.sumida.com

Taipei
Tel.+886-2-8751-2737
FAX.+886-2-8751-2738
sales@tw.sumida.com

San Jose
Tel.+1-408-321-9660
FAX.+1-408-321-9308
sales@us.sumida.com

Mouser Electronics

Authorized Distributor

Click to View Pricing, Inventory, Delivery & Lifecycle Information:

Sumida:

[CDRH12D58/ANP-100MC](#) [CDRH12D58/ANP-150MC](#) [CDRH12D58/ANP-220MC](#) [CDRH12D58/ANP-470MC](#)
[CDRH50D23ANP-100NC](#) [CDRH50D23ANP-220NC](#) [CDRH50D23ANP-4R7NC](#) [CDRH50D23ANP-6R8NC](#)
[CDRH12D58/ANP-820MC](#) [CDRH12D58/ANP-390MC](#) [CDRH12D58/ANP-271MC](#) [CDRH12D58/ANP-180MC](#)
[CDRH12D58/ANP-330MC](#) [CDRH12D58/ANP-221MC](#) [CDRH12D58/ANP-391MC](#) [CDRH12D58/ANP-560MC](#)
[CDRH12D58/ANP-120MC](#) [CDRH12D58/ANP-151MC](#) [CDRH12D58/ANP-181MC](#) [CDRH12D58/ANP-101MC](#)
[CDRH12D58/ANP-680MC](#) [CDRH12D58/ANP-331MC](#) [CDRH12D58/ANP-121MC](#) [CDRH12D58/ANP-270MC](#)