

Features

- Compact size (38.5 x 20.0mm)
- High RX sensitivity (-103dBm)
- Outperforming link budget (up to +112dB)
- Up to +9.0dBm output power
- Very low power consumption:
 - 8.7mA in RX mode ⁽¹⁾
 - 34.8mA in TX mode ⁽¹⁾
 - 0.6µA in sleep mode ⁽²⁾
- Ample memory resources (256KB In-System, Self-Programmable Flash memory, 4KB EEPROM, 16KB SRAM)
- Wide range of interfaces (both analog and digital)
 - 4-wire SPI, TWI
 - ISP, JTAG
 - Two analog comparator input
 - UART, USART
 - Timer, PWM
 - Four ADC lines
 - External Clock Input, Internal Clock Output
 - Up to 32 lines configurable as GPIO
- Preassigned Atmel® MAC address that can be used on end product
- Capability to use MAC address into the internal EEPROM
- IEEE® 802.15.4 compliant Transceiver
- 900MHz ISM band
- Serial bootloader
- High Performance Low Power Atmel AVR® XMEGA® 8- and 32-bit Microcontroller
- Rapid design-in with built-in Chip Antenna
- RF Test point using MS-147 RF connector
- Small physical footprint and low profile for optimum fit in very small application boards
- Mesh networking capability
- Easy-to-use low cost development kit
- Single source of support for HW and SW
- Worldwide license-free operation

- Notes:
1. MCU is in active state with 3V Supply, CPU clock @ 16MHz, RX RPC enabled (for RX current), PHY_TX_PWR=0x0 (for TX current), all digital outputs pulled high.
 2. Controller Sleep Mode: SLEEP_MODE_PWR_DOWN.

Table of Contents

1. Introduction	3
1.1 Summary.....	3
1.2 Applications.....	3
1.3 Abbreviations and Acronyms	3
1.4 Related Documents.....	4
2. ZigBit Module Overview	5
2.1 Overview	5
3. Specifications.....	7
3.1 Electrical Characteristics.....	7
3.1.1 Absolute Maximum Ratings	7
3.1.2 Power Supply.....	7
3.1.3 RF Characteristics	8
3.1.4 ATxmega256A3U Microcontroller Characteristics	9
3.1.5 Module Interfaces Characteristics.....	9
3.2 Physical/environmental Characteristics and Outline	9
3.3 Pin Configuration.....	10
3.4 Antenna Orientation Recommendation	11
3.5 Mounting Information	11
3.6 Soldering Profile.....	14
3.7 Antenna Reference Designs	14
4. Schematics	15
4.1 Handling Instructions.....	20
4.2 General Recommendations	20
5. Persistence Memory	21
6. Ordering Information	22
7. Agency Certifications	23
7.1 United States (FCC).....	23
7.2 Industry Canada (IC) Compliance Statements.....	23
8. Revision History	25

1. Introduction

1.1 Summary

ATZB-X0-256-4-0-CN ZigBit® is an ultra-compact and low-power 900MHz IEEE 802.15.4/ZigBee® OEM module from Atmel. Based on the innovative mixed-signal hardware platform from Atmel, this module uses the ATxmega256A3U [1] Microcontroller and AT86RF212B [5] 700/800/900MHz ISM band Transceiver. The radio transceiver provides high data rates from 20kb/s up to 1Mb/s, frame handling, outstanding receiver sensitivity and high transmit output power enabling a very robust wireless communication. The module is designed for wireless sensing, monitoring, control, data acquisition applications, to name a few. This ZigBit module eliminates the need for costly and time-consuming RF development, and shortens time-to-market for wireless applications.

The module has an MS-147 RF connector that can be used as an RF test port. The built-in chip antenna is designed and tuned for the ZigBit design to enable quick integration of the ZigBit into any application.

1.2 Applications

The ZigBit module is compatible with robust IEEE 802.15.4/ZigBee stack that supports a self-healing, self-organizing mesh network, while optimizing network traffic and minimizing power consumption.

For detailed software support information, visit <http://www.atmel.com/products/wireless>.

The applications include, but are not limited to:

- Building automation and monitoring
 - Lighting controls
 - Wireless smoke- and CO-detectors
 - Structural integrity monitoring
- HVAC monitoring and control
- Inventory management
- Environmental monitoring
- Security
- Water metering
- Industrial monitoring
 - Machinery condition and performance monitoring
 - Monitoring of plant system parameters such as temperature, pressure, flow, tank level, humidity, vibration, etc.
- Automated meter reading (AMR)

1.3 Abbreviations and Acronyms

ADC	Analog-to-Digital Converter
API	Application Programming Interface
DC	Direct Current
DTR	Data Terminal Ready
EEPROM	Electrically Erasable Programmable Read-Only Memory
ESD	Electrostatic Discharge
GPIO	General Purpose Input/output
HAF	High Frequency
HVAC	Heating, Ventilating, and Air Conditioning

HW	Hardware
I ² C	Inter-Integrated Circuit
IEEE	Institute of Electrical and Electronics Engineers
IRQ	Interrupt Request
ISM	Industrial, Scientific and Medical radio band
JTAG	Digital interface for debugging of embedded device, also known as IEEE 1149.1 standard interface
MAC	Medium Access Control layer
MCU	Microcontroller Unit. In this document it also means the processor, which is the core of a ZigBit module
NRE	Network layer
OEM	Original Equipment Manufacturer
OTA	Over-The-Air upgrade
PA	Power Amplifier
PCB	Printed Circuit Board
PER	Package Error Ratio
RAM	Random Access Memory
RF	Radio Frequency
RPC	Reduced Power Consumption
RTS/CTS	Request to Send/ Clear to Send
RX	Receiver
SMA	Surface Mount Assembly
SoC	System on Chip
SPI	Serial Peripheral Interface
SW	Software
TTM	Time-To-Market
TX	Transmitter
UART	Universal Asynchronous Receiver/Transmitter
USART	Universal Synchronous/Asynchronous Receiver/Transmitter
USB	Universal Serial Bus
ZigBee, ZigBee PRO	Wireless networking standards targeted at low-power applications
802.15.4	The IEEE 802.15.4-2003 standard applicable to low-rate wireless Personal Area Network

1.4 Related Documents

- [1] ATXMEGA256A3U Datasheet in <http://www.atmel.com/devices/ATXMEGA256A3U.aspx?tab=documents>.
- [2] MS-147 Series Interface RF Connector with Switch, 3.9mm High, DC to 6GHz
http://www.hirose.co.jp/cataloge_hp/e35801505.pdf.
- [3] IEEE Std 802.15.4-2003 IEEE Standard for Information technology - Part 15.4 Wireless Medium Access Control (MAC) and Physical Layer (PHY) Specifications for Low-Rate Wireless Personal Area Networks (LR-WPANs).
- [4] ZigBee Specification. ZigBee Document 053474r17, October 19, 2007.
- [5] AT86RF212B Datasheet in <http://www.atmel.com/devices/AT86RF212B.aspx?tab=documents>.

2. ZigBit Module Overview

2.1 Overview

The ATZB-X0-256-4-0-CN ZigBit is a compact, low-power, high sensitivity IEEE 802.15.4/ZigBee OEM module. Based on a solid combination of the latest Atmel MCU Wireless hardware platform, 900MHz ISM band transceiver and Atmel Studio Wireless Composer - the ZigBit offers an unmatched combination of superior radio performance, ultra-low power consumption and exceptional ease of integration.

Figure 2-1. ATZB-X0-256-4-0-CN User Interface Diagram

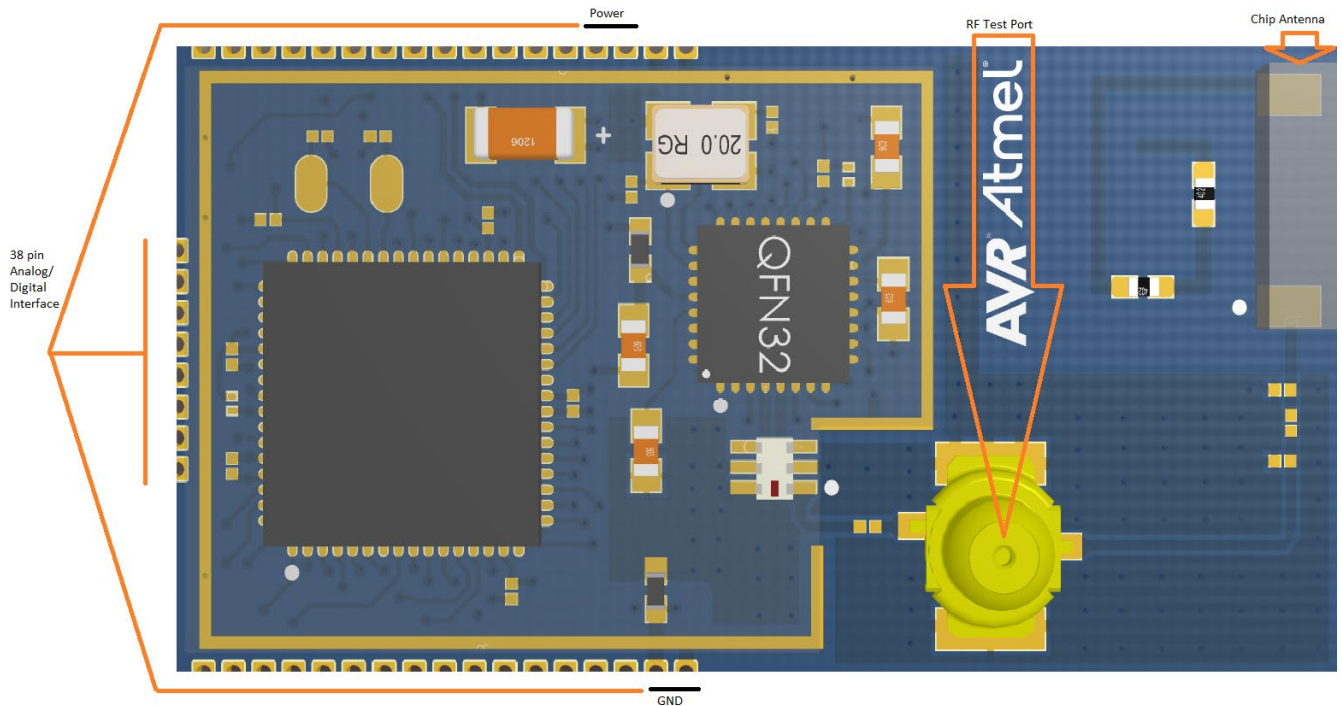

This ZigBit module contains the Atmel ATxmegaA256A3U Microcontroller and AT86RF212B 900MHz ISM band Transceiver for ZigBee and IEEE 802.15.4 [3]. The module features 256KB In-System Self-Programmable flash memory, 16KB SRAM, and 4KB EEPROM.

The compact all-in-one board design of MCU and Radio Transceiver with very minimal components on the RF path to Antenna dramatically improves the ZigBit's compact size, range performance on signal transmission and increases its sensitivity. This ensures stable connectivity within a larger coverage area, and helps develop applications on smaller footprint. The MS-147 connector [2] can be used as an RF Test port.

ZigBit Module contains a complete RF/MCU design with all the necessary passive components included. The module can be easily mounted on a simple 2-layer PCB with a minimum of required external connection. The ZigBit Module Evaluation kit containing the ZigBit Extension board for the Atmel Xplained PRO HW Evaluation platform can be used to develop FW using the Atmel Studio and evaluate using the Wireless Composer. Compared to a custom RF/MCU solution, a module-based solution offers considerable savings in development time and NRE cost per unit during the HW/FW design, prototyping, and mass production phases of product development.

All ZigBits are preloaded with a Bootloader when they are sold as Modules, either in Single units or T&R.

Depending on end-user design requirements, the ZigBit can operate as a self-contained sensor node, where it would function as a single MCU, or it can be paired with a host processor driving the module over a serial interface.

The MAC stack running on the host processor can then control data transmission and manages module peripherals. Thus very minimal firmware customization is required for successful module design-in. Third-party sensors can then be connected directly to the module, thus expanding the existing set of peripheral interfaces.

Every ZigBit Module come pre loaded with Atmel assigned 64-bit MAC address stored in the signature bytes of the device. This unique IEEE MAC address can be used as the MAC address of the end product, so there is no need to buy a MAC address separately for the product using the ZigBit.

3. Specifications

3.1 Electrical Characteristics

3.1.1 Absolute Maximum Ratings

Table 3-1. Absolute Maximum Ratings ⁽¹⁾⁽²⁾

Parameter	Minimum	Maximum
Voltage on any pin, except RESET with respect to ground	-0.3V	3.6V ($V_{DD\ max}$)
Input RF level		+10dBm
Current into V_{CC} pins		200mA

- Notes:
1. Absolute Maximum Ratings are the values beyond which damage to the device may occur. Under no circumstances must the absolute maximum ratings given in this table be violated. Stresses beyond those listed under "Absolute Maximum Ratings" may cause permanent damage to the device.
This is a stress rating only. Functional operation of the device at these or other conditions, beyond those indicated in the operational sections of this specification, is not implied. Exposure to absolute maximum rating conditions for extended periods may affect device reliability.
 2. **Attention!** ZigBit is an ESD-sensitive device. Precaution should be taken when handling the device in order to prevent permanent damage.

3.1.2 Power Supply

Table 3-2. Test Conditions (unless otherwise stated), $V_{CC} = 3V$, $T_{amb} = 25^{\circ}C$

Parameter	Range	Unit
Supply voltage, V_{DD}	1.8 to 3.6	V
Active Current consumption: RX mode + Max sensitivity	14.5	mA
Active Current consumption: RX mode + Least sensitivity	13.9	mA
Active Current consumption: RX mode + Max sensitivity, MCU Sleep ⁽²⁾	9.3	mA
Active Current consumption: RX mode + Least sensitivity, MCU Sleep ⁽²⁾	8.7	mA
Active Current consumption: TX mode ⁽¹⁾ – BUSY_TX – Transmit state	34.8	mA
Current consumption: TRX_OFF, MCU Active	6.1	mA
Current consumption: TRX_OFF, MCU Sleep ⁽²⁾	740	μA
Sleep Current consumption: TRX Sleep, MCU Sleep ⁽²⁾	0.6	μA

Note 1: Output TX power (when measuring consumption in TX mode) is +9dBm.

Note 2:

- a) All interfaces are set to the default state (see [Table 3-8 ATZB-X0-256-4-0-CN Pinout Description](#)).
- b) JTAG is not connected.
- c) CPU Clock configured when doing this measurement – 16MHz for all modes except Power save and Power down modes.

Current consumption depends on multiple factors, including but not limited to, the board design and materials, Protocol settings, network activity, EEPROM read/write operations. It also depends on MCU load and/or peripherals used by an application.

3.1.3 RF Characteristics

Table 3-3. RF Characteristics ⁽³⁾

Parameter	Condition	Range	Unit
Frequency band – FCC and Industry Canada ⁽²⁾		902 – 928	MHz
Numbers of channels (FCC and Industry Canada)		10	
Channel spacing		2	MHz
Transmitter output power	Adjusted in 36 steps	-25 to +11	dBm
Receiver sensitivity	PER = 1%	-103	dBm
On-air data rate		20, up to 1000	Kbps
TX output/ RX input nominal impedance	For balanced	50	Ω
Range ⁽¹⁾	Open field, LoS, Elevated	1120	m

- Notes:
1. Range measured is Line of Sight at 10ft elevation from Ground at different combinations of orientation of transmitter and receiver, with special conditions were there is minimal or no RF interference from other sources. For best case orientation of the ZigBits to achieve maximum range, refer to Section 3.4.
 2. Appropriate FW (Register selection) must be used for operating this ZigBit in North America.
 3. For detailed characteristics, refer to [2].

Table 3-4. TX Power Settings

PHY_TX_PWR 3:0 Register Value	Power Register Setting [dBm]	Output Power [dBm] (typical values at RF connector)
C0	11	8.59
C1	10	8.14
80	9	7.43
82	8	5.85
83	7	4.97
84	6	4.1
40	5	3.58
86	4	2.12
00	3	1.4
01	2	0.42
02	1	-0.93
03	0	-2.09
04	-1	-3.16
27	-2	-4.29
91	-6	-7.86
0D	-10	-12.27
15	-18	-19.51
1D	-25	-26.82

3.1.4 ATxmega256A3U Microcontroller Characteristics

Table 3-5. ATxmega256A3U Characteristics

Parameter	Range	Unit
On-chip flash memory size	256K	Bytes
On-chip RAM size	16K	Bytes
On-chip EEPROM size	4K	Bytes
Operation frequency	16	MHz

3.1.5 Module Interfaces Characteristics

Table 3-6. Module Interfaces Characteristics ⁽¹⁾

Parameters	Condition	Range	Unit
UART maximum baud rate		115.2	Kbps
ADC conversion time (latency)	(RES+2)/2+(GAIN !=0) RES (Resolution) = 8 or 12	5-8	Clk _{ADC} cycles
ADC input resistance	Static load resistor of input signal	4.0	kΩ
ADC reference voltage (V _{REF})		1.0 to AV _{CC} - 0.6	V
ADC input voltage		0 - AV _{DD}	V
TWI maximum clock		400	kHz
GPIO High level input voltage	V _{CC} = 2.7-3.6V	2 to V _{CC} +0.3	V
GPIO Low level input voltage	V _{CC} = 2.7-3.6V	-0.3 to 0.3 V _{DD}	V
GPIO High level output voltage V _{OH}	V _{CC} = 3.0-3.6V	2.4 to 0.94V _{CC}	V
GPIO Low level output voltage V _{OL}	V _{CC} = 3.0-3.6V	0.05V _{CC} typ. Max. 0.4	V
Real-time oscillator frequency		32.768	kHz

Note 1: For detailed characteristics, refer to [1].

3.2 Physical/environmental Characteristics and Outline

Table 3-7. Physical Characteristics

Parameters	Value	Comments
Size	38.5 x 20.0mm	
Operating temperature range	-40°C to +85°C	-40°C to +85°C operational

3.3 Pin Configuration

Table 3-8. ATZB-X0-256-4-0-CN Pinout Description

Pin Out	Pin Descriptions	Function
1	AVSS	Analog Ground
2	AVSS	Analog Ground
3	DEVDD	Digital Power input pin
4	DEVDD	Digital Power input pin
5	RSET/PDI_CLOCK	RESET
6	PD4/SS	SPI
7	PD5/MOSI/XCK1	SPI
8	PD6/MISO/RXD1/D-	SPI
9	PD7/SCK/TXD1/D+	SPI
10	PA5	GPIO / ADC / Analog COMP+
11	PA4	GPIO/ADC/Analog Comp-
12	DVSS	Digital Ground
13	PD2/SYNC/ASYNC/OC0C/	UART
14	PD3/SYNC/TXD0/OC0D	UART
15	PD1/SCL/INT/OC0B	USART
16	PDI_DATA	PWM/TC
17	PA6	GPIO/ADC
18	PA7	GPIO/ADC
19	PB3	GPIO/ADC/DAC1
20	PB2	GPIO/ADC/DAC/intwkup
21	PF1/OC0B/INT/XCK0	INT/PWM/GPIO
22	PF2/OC0C/INT/RXD0	INT/PWM/GPIO
23	PF3/OC0D/INT/TXD0	INT/PWM/GPIO
24	PB0/IAREF/INT	ADC ref
25	PA0/ADC0/INT	ADC/ GPIO
26	PA1/ADC1/INT	ADC/ GPIO
27	PA2/ADC2/INT	ADC/ GPIO
28	PA3/ADC3/INT	ADC/ GPIO
29	DVSS	Digital Ground
30	PB6/TCK/INT	JTAG
31	PB4/TMS/INT	JTAG
32	PB7/TDO/INT	JTAG
33	PB5/TDI/INT	JTAG
34	PE3/TXD	GPIO/output counter
35	PE2/RXD	Wakeup INT
36	PE1/XCK	TWI/INT/GPIO
37	PE0	TWI/INT/GPIO
38	PE5/OC1B/INT	GPIO/TC
39	PE4/SYNC/OC1A	Master Clock out put

Pin Out	Pin Descriptions	Function
40	PF0	GPIO/Timer
41	DVSS	Digital Ground
42	DVSS	Digital Ground

NOTE: TXD, RXD of UART are crossed inside ZigBit Module. External UART devices connecting to ZigBit Module should follow straight connection for UART.

UART_TXD_external_device <-> UART_TXD

UART_RXD_external_device <-> UART_RXD

3.4 Antenna Orientation Recommendation

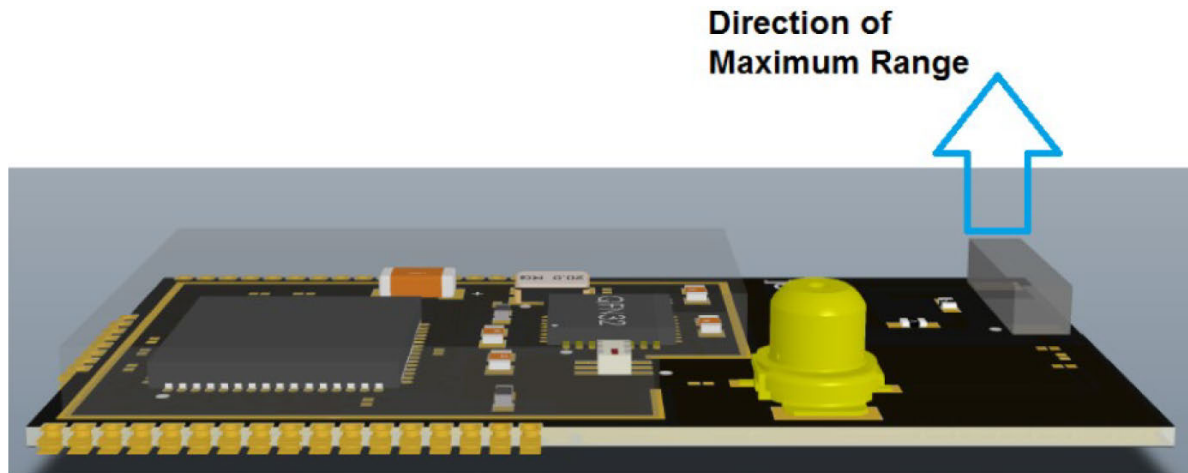

The Antenna in this module is designed to provide the best possible LoS range in the direction indicated in this illustration.

3.5 Mounting Information

Figure 3-1 shows the PCB layout recommended for a ZigBit module. Neither via-holes nor wires are allowed on the PCB upper layer in the area occupied by the module. As a critical requirement, RF_GND pins should be grounded via several via-holes to be located right next to the pins thus minimizing inductance and preventing both mismatch and losses.

Figure 3-1. ATZB-X0-256-4-0-CN Dimensions

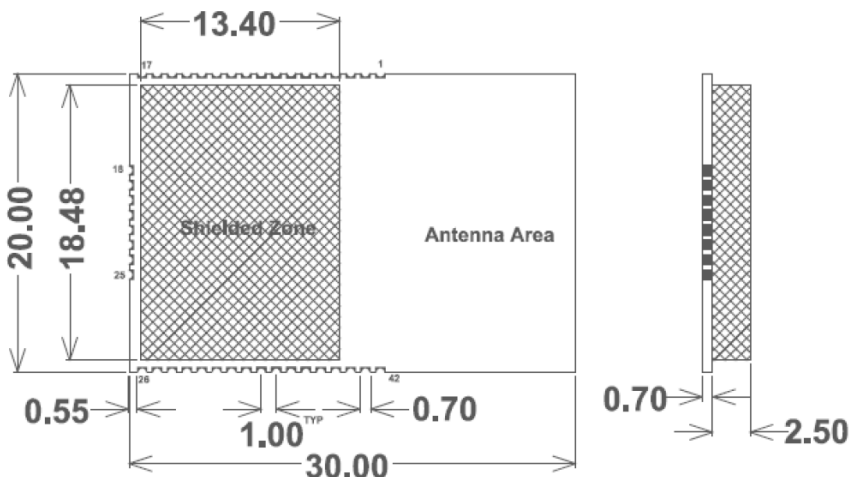

Figure 3-2. ATZB-X0-256-4-0-CN Pinout

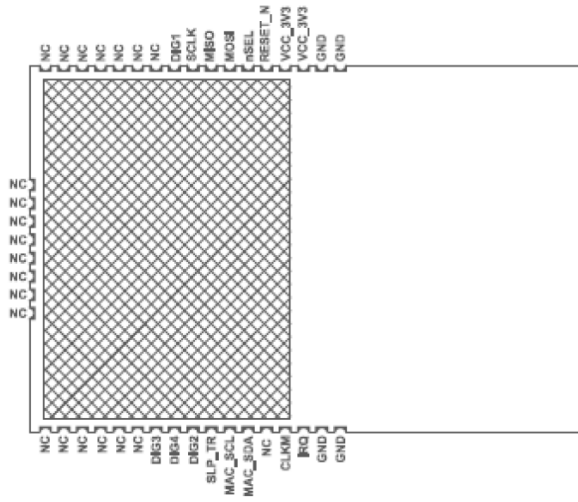

Figure 3-3. ATZB-X0-256-4-0-CN Foot Print Dimensions

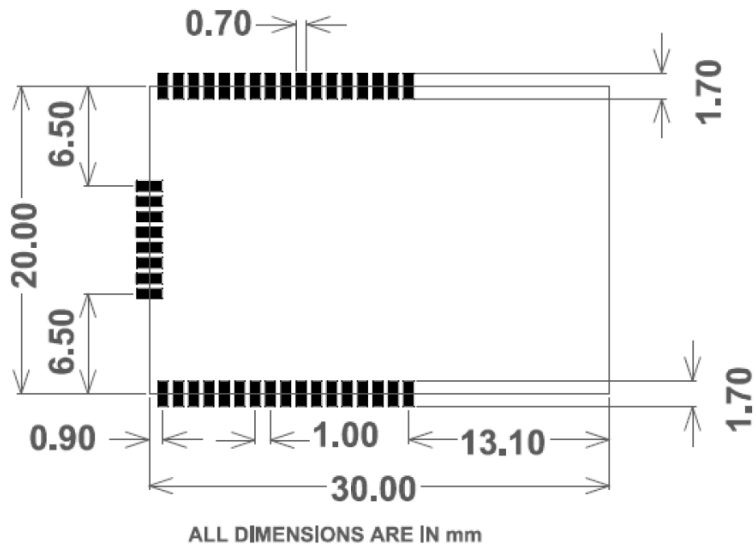

Figure 3-4. ATZB-X0-256-4-0-CN Mounting Information (preferred placement)

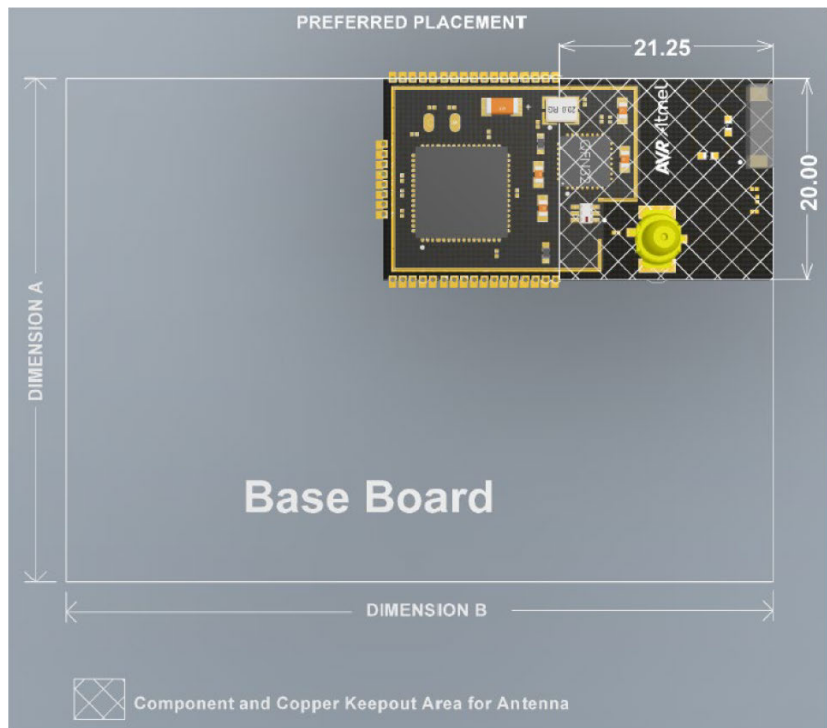
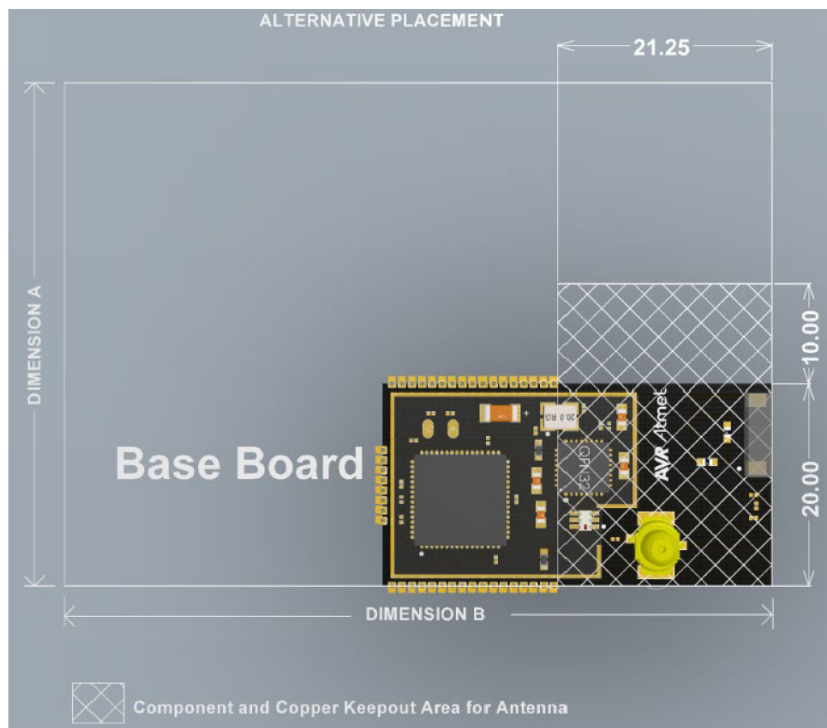

Figure 3-5. ATZB-X0-256-4-0-CN Mounting Information (alternative placement)



The ZigBit's location and orientation on the carrier board is illustrated in the above PCB Land pattern and Mounting information drawing. The Recommended placement of ZigBit on Carrier Board needs to be accurately followed to ensure performance on the end application.

3.6 Soldering Profile

The J-STD-020C-compliant soldering profile is recommended according to [Table 3-9](#).

Table 3-9. Soldering profile ⁽¹⁾

Profile Feature	Green Package
Average ramp-up rate (217°C to peak)	3°C/s max.
Preheat temperature 175°C ±25°C	180s max.
Temperature maintained above 217°C	60s to 150s
Time within 5°C of actual peak temperature	20s to 40s
Peak temperature range	260°C
Ramp-down rate	6°C/s max.
Time within 25°C to peak temperature	8 minutes

Note: 1. The package is backward compatible with PB/Sn soldering profile.

3.7 Antenna Reference Designs

Multiple factors affect proper antenna match, hence, affecting the antenna pattern. The particular factors are the board material and thickness, shields, the material used for enclosure, the board neighborhood, and other components adjacent to antenna. Following guidelines need to be followed when designing the base board for the ZigBit.

General Recommendations:

- Metal enclosure should not be used. Using low profile enclosure might also affect antenna tuning.
- Placing high profile components next to antenna should be avoided
- Having holes/vias punched around the periphery of the board eliminates parasitic radiation from the board edges also distorting antenna pattern
- ZigBit module should not be placed next to consumer electronics which might interfere with ZigBit's RF band frequency

The board design should prevent propagation of microwave field inside the board material. Electromagnetic waves of high frequency may penetrate the board thus making the edges of the board radiate, which may distort the antenna pattern. To eliminate this effect, metalized and grounded holes/vias must be placed around the board's edges.

4. Schematics

The following schematic drawings for the ATZB-X0-256-4-0-CN are in the following order:

- Top level schematics
- Connector schematics
- ATxmega256A3U schematics
- AT86RF212B schematics

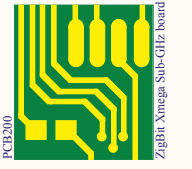
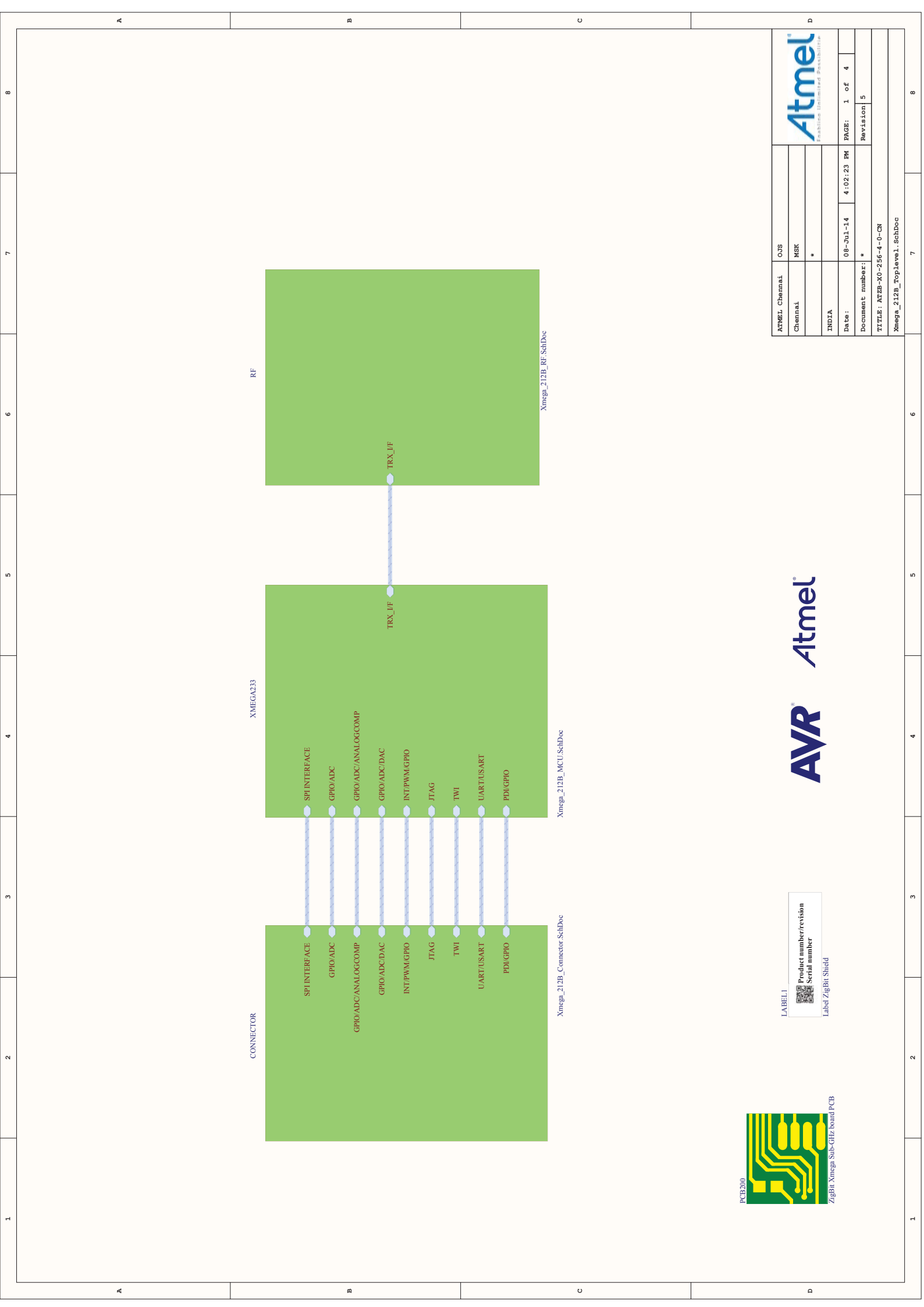

ATMEL Channel	OJS
Channel	MSK
INDIA	*
Date:	08-Jul-14
Document number:	*
TITLE: ATZB-XO-256-4-0-CN	
Xmega_212B_TopLevel1.SchDoc	
PAGE:	1 of 4
Revision:	5

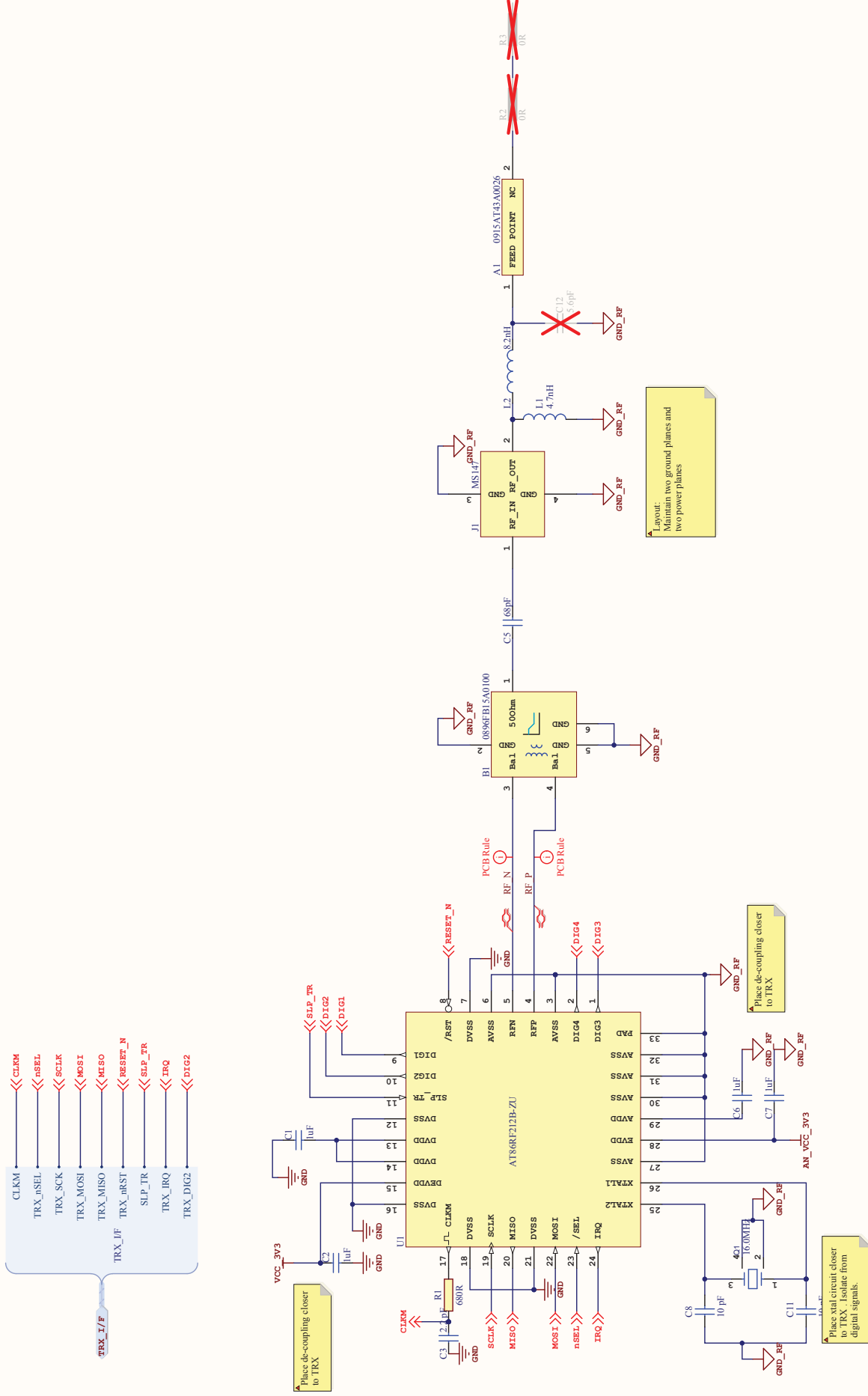

Layout: Maintain two ground planes and two power planes

Place decoupling capacitor closer to TRX

Place xtal circuit closer to TRX. Isolate from digital signals.

ATMEL India	OJS
RMZ Millennia	MSK
MGR Road	MSK
Chennai	
Date:	08-Jul-14
Document number:	A08-1567
TITLE: AT86RF212B_RF_SchDoc	
Xmega_212B_RF_SchDoc	

A B C

1 2 3 4 5 6 7 8

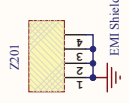
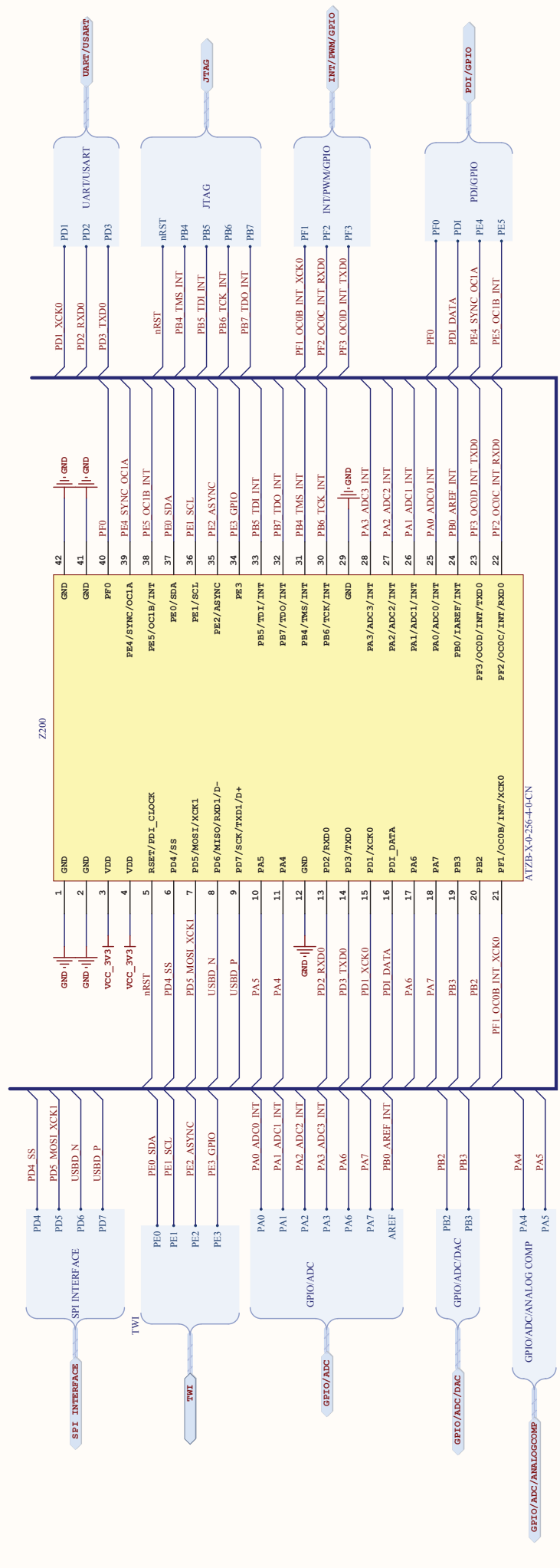

ATMEL Norway	OJS
Vestre Rosten	MSK
N-7075 TITLER	*
NORWAY	
Date:	08-Jul-14
Document number:	A08-1567
TITLE: ATZB-X0-256-4-0-CN	
Xmega_212B_Connector_SchDoc	

1 2 3 4 5 6 7 8

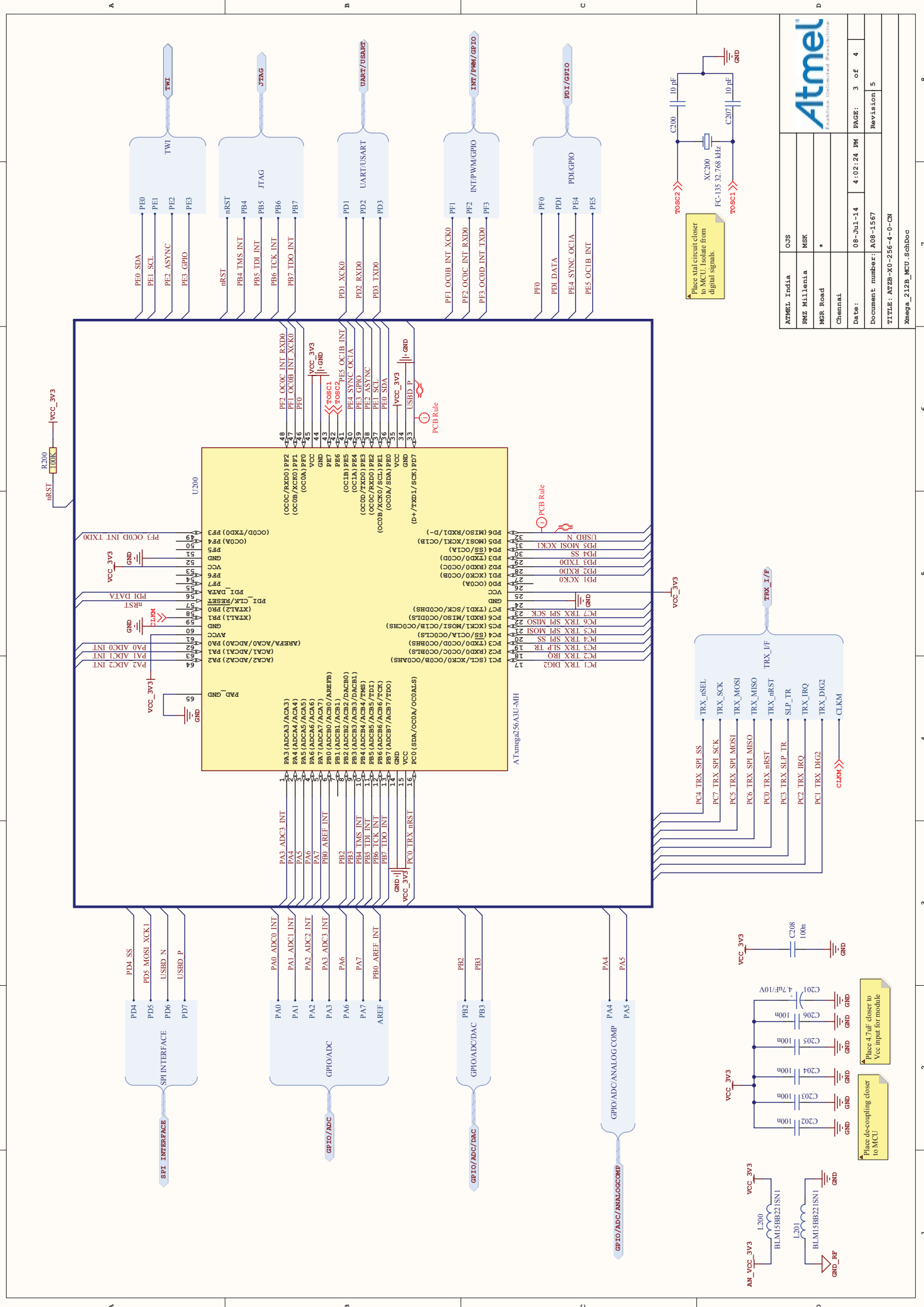

Place xtal circuit closer to MCU. Isolate from digital signals.

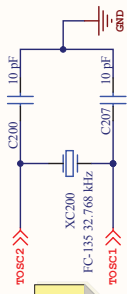

Place 4.7µF capacitor to Vcc input for module

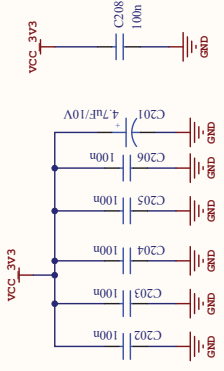

Place decoupling capacitor closer to MCU

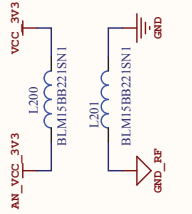

ATMEL India	OJS
RMZ Millenia	MSK
MGR Road	*
Chennai	
Date:	08-Jul-14
Document number:	A08-1567
TITLE: ATZB-X0-256-4-0-CN	
Xmega_212B_MCU_SchDoc	



4.1 Handling Instructions

The ZigBit Modules are fixed with an EMI Shield to ensure compliance to Emission and Immunity rules. This shield is galvanic and NOT air tight. So cleaning of the module with IPA / other similar agents is not advised. Humidity protection coating (conformal) will cause deviated RF behavior and coating material being trapped inside EMI Shield. So this should be avoided. For products requiring conformal coating, it is advised to suitably mask the ZigBit before applying the coating to rest of the ZigBit carrier board. To protect ZigBit from humidity, the housing of the product should ensure suitable Ingress Protection standards are complied with.

The MS-147 connector should never be exposed to Varnish / similar conformal coating material which will affect electrical connection on the surfaces of connector.

The in-built chip antenna has been tuned for the particular design.

4.2 General Recommendations

- Metal enclosure should not be used. Using low profile enclosure might also affect antenna tuning.
- Placing high profile components next to antenna should be avoided
- Having holes/vias punched around the periphery of the board eliminates parasitic radiation from the board edges also distorting antenna pattern
- ZigBit module should not be placed next to consumer electronics which might interfere with ZigBit's RF frequency band

5. Persistence Memory

A dedicated memory space is allocated to store product specific information and called the Persistence Memory. The organization of the persistence memory is as follows:

Table 5-1. Persistence Memory

Data	Size
Structure Revision	2 bytes
MAC address ⁽¹⁾	8 bytes
Board information overall	49 bytes
Board information – PCBA Name	30 bytes
Board information – PCBA Serial number	10 bytes
Board information – PCBA Atmel Part Number	8 bytes
Board information – PCBA Revision	1 byte
Reserved	3 bytes
XTAL Calibration Value	1 byte
Reserved	7 bytes
Reserved	4 bytes
CRC	1 byte

In ATZB-X0-256-4-0-CN, the persistence memory is stored in User Signature Row of ATxmega256A3U Microcontroller starting from address 0x0000. This section is not erased by chip erase and requires a dedicated erase command.

The user signature row is a separate memory section that is fully accessible (read and write) from application software and external programmers. See section “Read User Signature Row / Production Signature Row” under section “NVM Flash Commands” in XMEGA AU manual [1] for details in reading the user signature data from application software.

- Note:
1. The MAC address stored inside the MCU is a uniquely assigned ID for each ZigBit and owned by Atmel. User of the ZigBit application can use this unique MAC ID to address the ZigBit in end-applications. The MAC ID can be read from the ZigBit using the Performance Analyzer Application that is supplied through Atmel Studio Gallery Extension.

6. Ordering Information

Table 6-1. Ordering Information

Part Number	Description
ATZB-X0-256-4-0-CN	900 MHz IEEE802.15.4/ZigBee OEM module based on ATXMEGA256A3U MCU and AT86RF212B Transceiver with MS-147 test connector and chip antenna, Single unit
ATZB-X0-256-4-0-CNR	900 MHz IEEE802.15.4/ZigBee OEM module based on ATXMEGA256A3U MCU and AT86RF212B Transceiver with MS-147 test connector and chip antenna, Tape & Reel

Note: Tape & Reel quantity: 200.

7. Agency Certifications

7.1 United States (FCC)

This equipment complies with Part 15 of the FCC rules and regulations. To fulfill FCC Certification requirements, an OEM manufacturer must comply with the following regulations:

1. The ATZB-X0-256-4-0-CN modular transmitter must be labeled with its own FCC ID number, and, if the FCC ID is not visible when the module is installed inside another device, then the outside of the device into which the module is installed must also display a label referring to the enclosed module. This exterior label can use wording such as the following:

IMPORTANT: Contains FCC ID: VW4A091745. This equipment complies with Part 15 of the FCC Rules. Operation is subject to the following two conditions: (1) this device may not cause harmful interference, and (2) this device must accept any interference received, including interference that may cause undesired operation (FCC 15.19).

The internal antenna used for this mobile transmitter must provide a separation distance of at least 20cm from all persons and must not be collocated or operating in conjunction with any other antenna or transmitter.

Installers must be provided with antenna installation instructions and transmitter operating conditions for satisfying RF exposure compliance. This device is approved as a mobile device with respect to RF exposure compliance, and may only be marketed to OEM installers. Use in portable exposure conditions (FCC 2.1093) requires separate equipment authorization.

IMPORTANT: Modifications not expressly approved by this company could void the user's authority to operate this equipment (FCC section 15.21).

IMPORTANT: This equipment has been tested and found to comply with the limits for a Class A digital device, pursuant to Part 15 of the FCC Rules. These limits are designed to provide reasonable protection against harmful interference when the equipment is operated in a commercial environment. This equipment generates, uses, and can radiate radio frequency energy and, if not installed and used in accordance with the instruction manual, may cause harmful interference to radio communications. Operation of this equipment in a residential area is likely to cause harmful interference in which case the user will be required to correct the interference at his own expense (FCC section 15.105).

7.2 Industry Canada (IC) Compliance Statements

This device complies with Industry Canada licence-exempt RSS standard(s). Operation is subject to the following two conditions: (1) this device may not cause interference, and (2) this device must accept any interference, including interference that may cause undesired operation of the device.

Le présent appareil est conforme aux CNR d'Industrie Canada applicables aux appareils radio exempts de licence. L'exploitation est autorisée aux deux conditions suivantes: (1) l'appareil ne doit pas produire de brouillage, et (2) l'utilisateur de l'appareil doit accepter tout brouillage radioélectrique subi, même si le brouillage est susceptible d'en compromettre le fonctionnement.

This equipment complies with radio frequency exposure limits set forth by Industry Canada for an uncontrolled environment. This equipment should be installed and operated with minimum distance 20cm between the device and the user or bystanders.

Cet équipement est conforme aux limites d'exposition aux radiofréquences définies par Industrie Canada pour un environnement non contrôlé. Cet équipement doit être installé et utilisé avec un minimum de 20cm de distance entre le dispositif et l'utilisateur ou des tiers.

CAUTION: Any changes or modifications not expressly approved by the party responsible for compliance could void the user's authority to operate the equipment.

The OEM integrator is still responsible for testing their end-product for any additional compliance requirements required with this module installed (for example, digital device emissions, PC peripheral requirements, etc.).

This Module is labelled with its own IC ID. If the IC ID Certification Number is not visible while installed inside another device, then the device should display the label on it referring the enclosed module. In that case, the final end product must be labelled in a visible area with the following:

“Contains Transmitter Module IC: 11019A-091745”

OR

“Contains IC: 11019A-091745”

Ce module est étiqueté avec son propre ID IC. Si le numéro de certification IC ID n'est pas visible lorsqu'il est installé à l'intérieur d'un autre appareil, l'appareil doit afficher l'étiquette sur le module de référence ci-joint. Dans ce cas, le produit final doit être étiqueté dans un endroit visible par le texte suivant:

“Contains Transmitter Module IC: 11019A-091745”

OR

“Contains IC: 11019A-091745”

8. Revision History

Doc. Rev.	Date	Comments
42268C	02/2015	Former Section 7.2 “European Union (ETSI)” has been removed
42268B	07/2014	Updated schematics pages 16 to 19
42268A	04/2014	Initial document release

**Atmel Corporation**

1600 Technology Drive
San Jose, CA 95110
USA

Tel: (+1)(408) 441-0311

Fax: (+1)(408) 487-2600

www.atmel.com

Atmel Asia Limited

Unit 01-5 & 16, 19F
BEA Tower, Millennium City 5
418 Kwun Tong Road
Kwun Tong, Kowloon

HONG KONG

Tel: (+852) 2245-6100

Fax: (+852) 2722-1369

Atmel Munich GmbH

Business Campus
Parking 4
D-85748 Garching b. Munich
GERMANY

Tel: (+49) 89-31970-0

Fax: (+49) 89-3194621

Atmel Japan G.K.

16F Shin-Osaki Kangyo Building
1-6-4 Osaki, Shinagawa-ku
Tokyo 141-0032
JAPAN

Tel: (+81)(3) 6417-0300

Fax: (+81)(3) 6417-0370

© 2015 Atmel Corporation. All rights reserved. / Rev.: 42268C–WIRELESS–02/2015

Atmel®, Atmel logo and combinations thereof, AVR®, BitCloud®, Enabling Unlimited Possibilities®, ZigBit®, XMEGA®, and others are registered trademarks or trademarks of Atmel Corporation or its subsidiaries. Other terms and product names may be trademarks of others.

Disclaimer: The information in this document is provided in connection with Atmel products. No license, express or implied, by estoppel or otherwise, to any intellectual property right is granted by this document or in connection with the sale of Atmel products. EXCEPT AS SET FORTH IN THE ATMEL TERMS AND CONDITIONS OF SALES LOCATED ON THE ATMEL WEBSITE, ATMEL ASSUMES NO LIABILITY WHATSOEVER AND DISCLAIMS ANY EXPRESS, IMPLIED OR STATUTORY WARRANTY RELATING TO ITS PRODUCTS INCLUDING, BUT NOT LIMITED TO, THE IMPLIED WARRANTY OF MERCHANTABILITY, FITNESS FOR A PARTICULAR PURPOSE, OR NON-INFRINGEMENT. IN NO EVENT SHALL ATMEL BE LIABLE FOR ANY DIRECT, INDIRECT, CONSEQUENTIAL, PUNITIVE, SPECIAL OR INCIDENTAL DAMAGES (INCLUDING, WITHOUT LIMITATION, DAMAGES FOR LOSS AND PROFITS, BUSINESS INTERRUPTION, OR LOSS OF INFORMATION) ARISING OUT OF THE USE OR INABILITY TO USE THIS DOCUMENT, EVEN IF ATMEL HAS BEEN ADVISED OF THE POSSIBILITY OF SUCH DAMAGES. Atmel makes no representations or warranties with respect to the accuracy or completeness of the contents of this document and reserves the right to make changes to specifications and products descriptions at any time without notice. Atmel does not make any commitment to update the information contained herein. Unless specifically provided otherwise, Atmel products are not suitable for, and shall not be used in, automotive applications. Atmel products are not intended, authorized, or warranted for use as components in applications intended to support or sustain life.

Mouser Electronics

Authorized Distributor

Click to View Pricing, Inventory, Delivery & Lifecycle Information:

[Microchip:](#)

[ATZB-X0-256-4-0-CN](#) [ATZB-X0-256-4-0-CNR](#)