

THIS DOCUMENT IS THE PROPERTY OF
KEYSTONE ELECTRONICS CORP. AND
SHALL NOT BE REPRODUCED, DISTRIBUTED
OR USED AS A BASIS FOR MANUFACTURE
WITHOUT PRIOR WRITTEN PERMISSION
FROM KEYSTONE ELECTRONICS CORP.

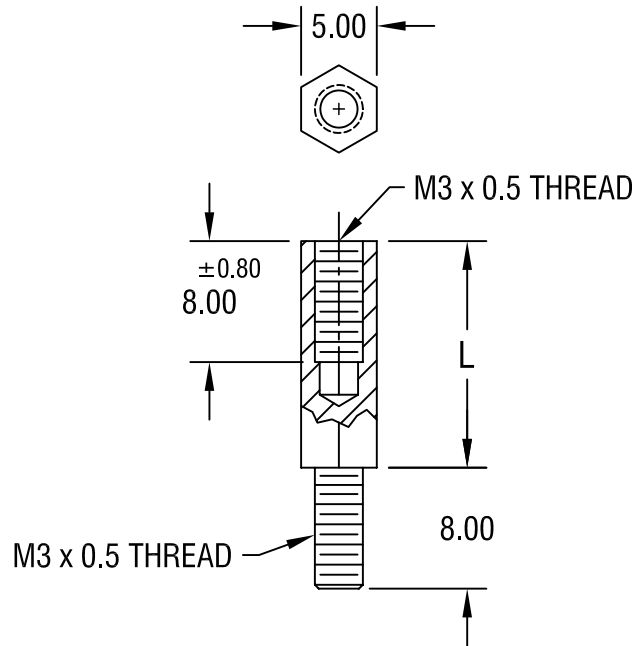

PART NO.	'L' DIM.
25501	10.00
25502	12.00
25503	15.00
25504	18.00
25505	20.00
25506	25.00

NOTE:

1. ALL DIMENSIONS ARE IN MILLIMETERS

KEYSTONE ELECTRONICS CORP.			
ASTORIA, N.Y. 11105-2017			
PART NAME 5mm M/F HEX STANDOFF			
MATERIAL NYLON 6/6			
FINISH -		DRN BY BOONE	DATE 7.18.06
		APP'D LN	SCALE 2X
TOLERANCES	INCH [MM]	CODE	DWG NO.
DECIMAL	± [± 0.40]	C/M	25501-25506
ANGULAR	± 1°		
UNLESS OTHERWISE SPECIFIED			

DATE	DESCRIPTION	REV.

Mouser Electronics

Authorized Distributor

Click to View Pricing, Inventory, Delivery & Lifecycle Information:

[Keystone Electronics:](#)

[25504](#)