



92x92x25 mm

San Ace 92 9GA type Low Power Consumption Fan

General Specifications

- Material Frame: Plastic (Flammability: UL 94V-0), Impeller: Plastic (Flammability: UL 94V-0)
- Expected life See the table below. (L10 life: 90% survival rate for continuous operation in free air at 60°C, rated voltage)
- Motor protection function Locked rotor burnout protection, Reverse polarity protection
For details, please refer to p. 529.
- Dielectric strength 50/60 Hz, 500 VAC, for 1 minute (between lead wire conductors and frame)
- Insulation resistance 10 MΩ or more with a 500 VDC megger (between lead wire conductors and frame)
- Sound pressure level (SPL) At 1 m away from the air inlet
- Storage temperature -30 to +70°C (Non-condensing)
- Lead wire ⊕Red ⊖Black (Sensor) Yellow (Control) Brown
- Mass 125 g

Specifications

The models listed below **have ribs and pulse sensors with PWM control function.** For models without ribs, append "1" to the end of model numbers.

Model no.	Rated voltage [V]	Operating voltage range [V]	PWM duty cycle* [%]	Rated current [A]	Rated input [W]	Rated speed [min ⁻¹]	Max. airflow [m ³ /min] [CFM]	Max. static pressure [Pa] [inchH ₂ O]	SPL [dB (A)]	Operating temperature [°C]	Expected life [h]
9GA0912P4J03	12	10.2 to 13.8	100	0.39	4.68	5000	2.2 77.7	105 0.42	43	-20 to +70	60000/60°C
			0	0.06	0.72	1500	0.65 23.3	9.4 0.04	14		
9GA0912P4G03			100	0.28	3.36	4400	1.93 68.2	81 0.33	39		
			0	0.06	0.72	1500	0.65 23.3	9.4 0.04	14		
9GA0912P4S03			100	0.2	2.4	3800	1.67 59.0	60.6 0.24	35		
			0	0.06	0.72	1500	0.65 23.3	9.4 0.04	14		
9GA0924P4J03	24	20.4 to 27.6	100	0.2	4.8	5000	2.2 77.7	105 0.42	43		
			0	0.04	0.96	1500	0.65 23.3	9.4 0.04	14		
9GA0924P4G03			100	0.15	3.6	4400	1.93 68.2	81 0.33	39		
			0	0.04	0.96	1500	0.65 23.3	9.4 0.04	14		
9GA0924P4S03			100	0.12	2.88	3800	1.67 59.0	60.6 0.24	35		
			0	0.04	0.96	1500	0.65 23.3	9.4 0.04	14		

* PWM frequency: 25 kHz

Other sensor specifications are available as options. Refer to the index (p. 553).

Airflow - Static Pressure Characteristics / PWM Duty - Speed Characteristics Example

9GA0912P4J03 With pulse sensor with PWM control function

PWM duty cycle

Operating voltage range

PWM duty - Speed characteristics example

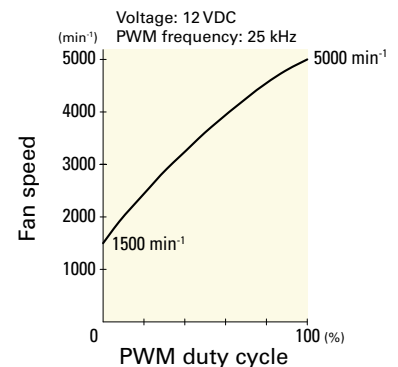
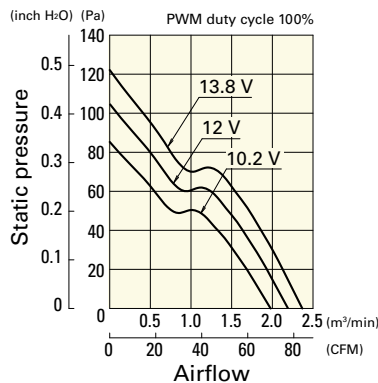
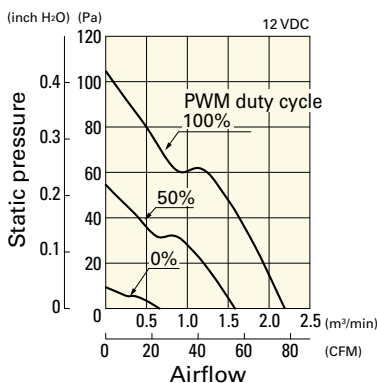

Airflow - Static Pressure Characteristics / PWM Duty - Speed Characteristics Example

9GA0912P4G03 With pulse sensor with PWM control function

PWM duty cycle

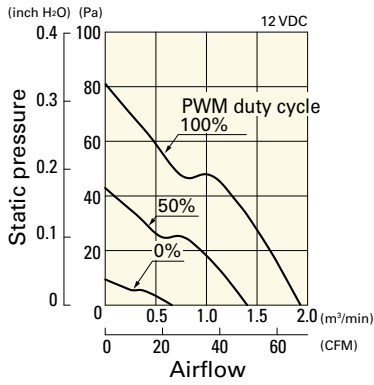

Operating voltage range

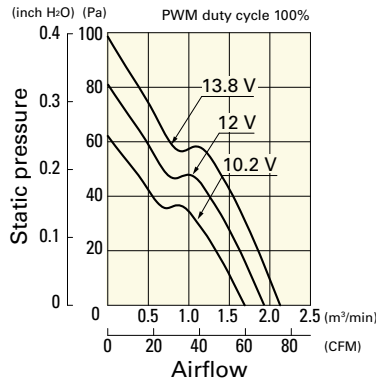

PWM duty - Speed characteristics example

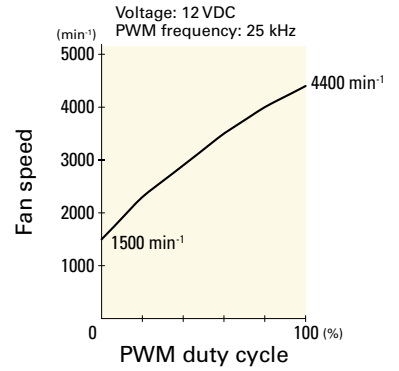

9GA0912P4S03 With pulse sensor with PWM control function

PWM duty cycle

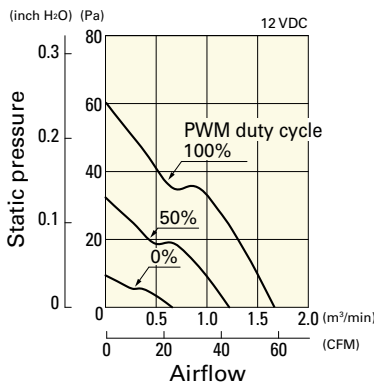

Operating voltage range

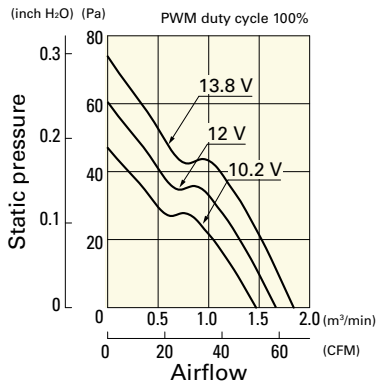

PWM duty - Speed characteristics example

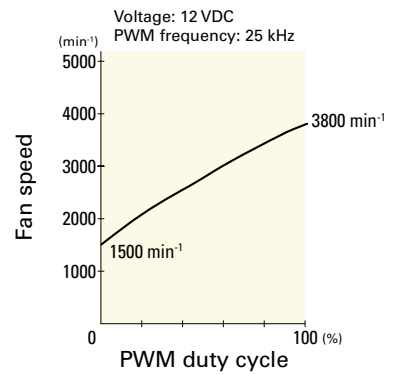

9GA0924P4J03 With pulse sensor with PWM control function

PWM duty cycle

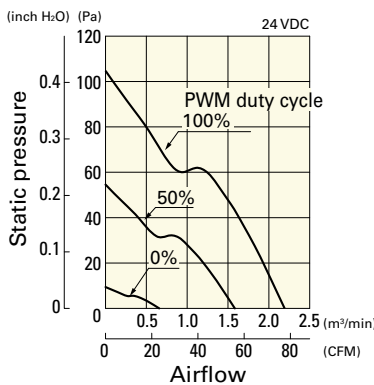

Operating voltage range

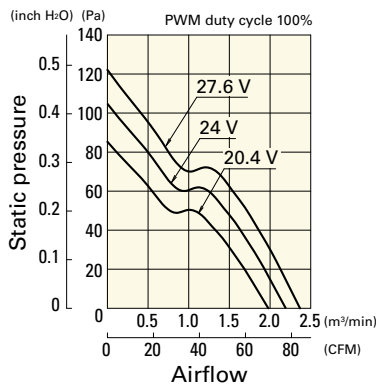

PWM duty - Speed characteristics example

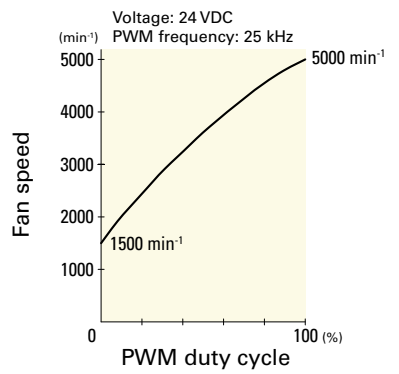

9GA0924P4G03 With pulse sensor with PWM control function

PWM duty cycle

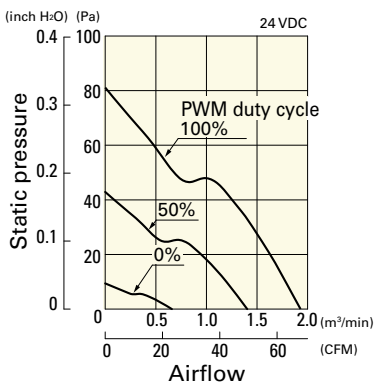

Operating voltage range

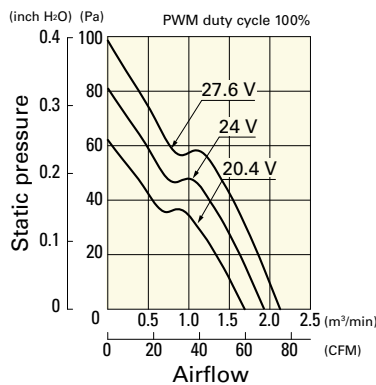

PWM duty - Speed characteristics example

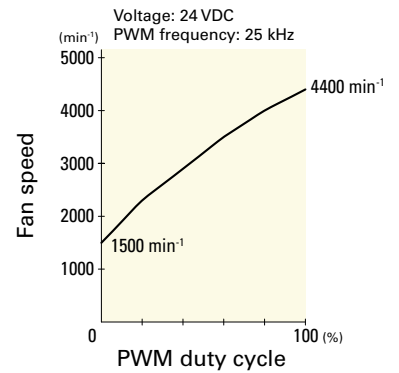

Airflow - Static Pressure Characteristics / PWM Duty - Speed Characteristics Example

9GA0924P4S03 With pulse sensor with PWM control function

PWM duty cycle

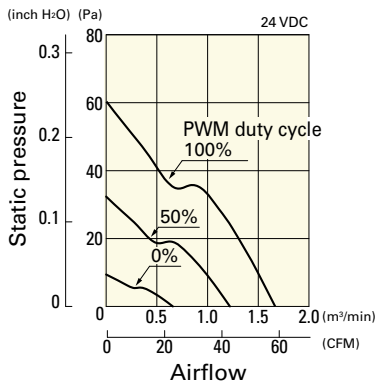

Operating voltage range

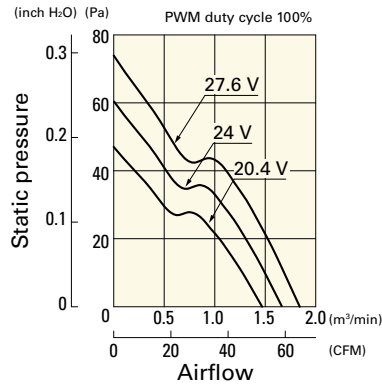

PWM duty - Speed characteristics example

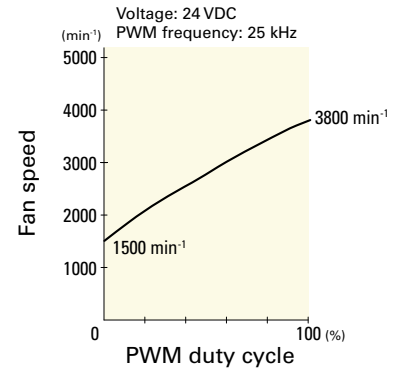

Dimensions (unit: mm) (With ribs)

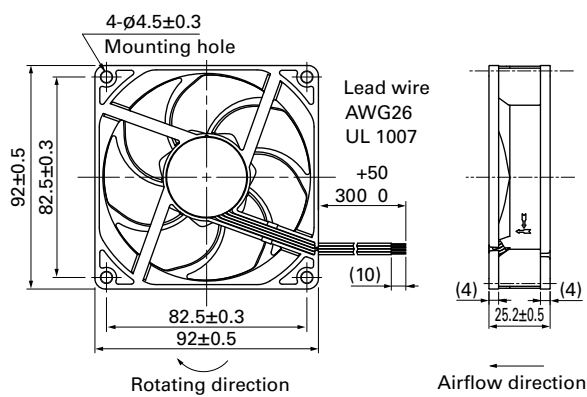

Reference Dimensions of Mounting Holes and Vent Opening (unit: mm)

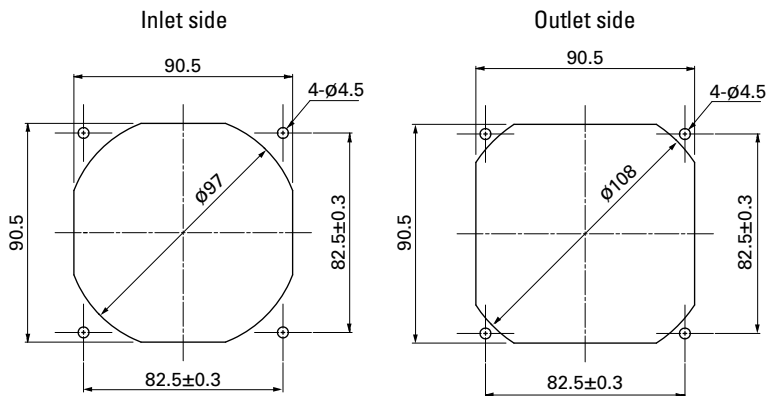

Options

Finger guards page: p. 513
Model no.: 109-099C, 109-099E, 109-099H

Resin finger guards page: p. 520
Model no.: 109-1001G

Resin filter kits page: p. 521
Model no.: 109-1001F13 (13PPI), 109-1001F20 (20PPI),
109-1001F30 (30PPI), 109-1001F40 (40PPI)

Mouser Electronics

Authorized Distributor

Click to View Pricing, Inventory, Delivery & Lifecycle Information:

Sanyo Denki:

[9GA0912P4G03](#) [9GA0912P4J03](#) [9GA0924P4J03](#) [9GA0912P4S03](#) [9GA0912P4J031](#) [9GA0912P4G031](#)
[9GA0924P4J031](#) [9GA0924P4G031](#) [9GA0912P4S031](#) [9GA0924P4S031](#) [9GA0924P4G03](#) [9GA0924P4S03](#)
[9GA0924J401](#) [9GA0924G401](#) [9GA0924S401](#) [9GA0924J402](#) [9GA0912J401](#) [9GA0912J4011](#) [9GA0912G402](#)
[9GA0912J402](#) [9GA0912J4021](#) [9GA0912J4D01](#) [9GA0912S402](#) [9GA0912J4D011](#) [9GA0912G401](#) [9GA0912G4011](#)
[9GA0912G4021](#) [9GA0912G4D01](#) [9GA0924S402](#) [9GA0924S4021](#) [9GA0924G4021](#) [9GA0924G4D01](#) [9GA0924J4011](#)
[9GA0924J4021](#) [9GA0924J4D01](#) [9GA0924S4011](#) [9GA0912S401](#) [9GA0912S4011](#) [9GA0912S4021](#) [9GA0924G4011](#)
[9GA0924G402](#)