

Aximax, 400, Conformally Coated, X7R Dielectric, 25 – 250 VDC (Commercial Grade)

Overview

KEMET's Aximax conformally coated axial leaded ceramic capacitors in X7R dielectric feature a 125°C maximum operating temperature. The Electronics Industries Alliance (EIA) characterizes X7R dielectric as a Class II "temperature stable" material. Components of this classification are fixed, ceramic dielectric capacitors suited for bypass and decoupling applications or for frequency discriminating circuits where Q and stability of capacitance characteristics are not critical. X7R

exhibits a predictable change in capacitance with respect to time and voltage and boasts a minimal change in capacitance with reference to ambient temperature. Capacitance change is limited to $\pm 15\%$ from -55°C to $+125^{\circ}\text{C}$.

These devices meets the flame test requirements outlined in UL Standard 94V-0.

Benefits

- Axial leaded form factor
- Conformally coated
- Encapsulation meets flammability standard UL 94V-0
- Operating temperature range of -55°C to $+125^{\circ}\text{C}$
- Lead (Pb)-free, RoHS and REACH compliant
- X7R Temperature stable dielectric
- DC voltage ratings of 25 V, 50 V, 100 V, 200 V, and 250 V
- Capacitance offerings ranging from 10 pF to 10 μF
- Available capacitance tolerances of $\pm 5\%$, $\pm 10\%$ and $\pm 20\%$
- Non-polar device, minimizing installation concerns
- 100% pure matte tin-plated lead finish allowing for excellent solderability
- SnPb-plated lead finish option available upon request (Sn60/Pb40)

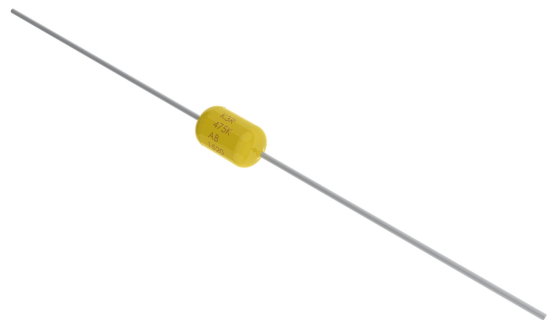

Ordering Information

| C | 410 | C | 105 | K | 3 | R | 5 | T | A | 7200 |
|---------|---------------------------------|-----------------------|--|---|---|------------|-------------------|---------------------------------------|--------------|---|
| Ceramic | Style/Size | Specification/ Series | Capacitance Code (pF) | Capacitance Tolerance ¹ | Rated Voltage (VDC) | Dielectric | Design | Lead Finish ² | Failure Rate | Packaging (C-Spec) |
| | 410 412 420 430 440 | C = Standard | First two digits represent significant figures. Third digit specifies number of zeros. | J = $\pm 5\%$ K = $\pm 10\%$ M = $\pm 20\%$ | 3 = 25 5 = 50 1 = 100 2 = 200 A = 250 | R = X7R | 5 = Multilayer | T = 100% Matte Sn H = SnPb (60/40) | A = N/A | Blank = Bulk 7200 = 12" Reel 7293 = Ammo Pack |

¹ Additional capacitance tolerance offerings may be available. Contact KEMET for details.

² Lead materials:

Standard: 100% matte tin (Sn) with nickel (Ni) underplate and steel core ("T" designation).

Alternative 1: 60% tin (Sn)/40% lead (Pb) finish with copper-clad steel core ("H" designation).

Alternative 2: 60% tin (Sn)/40% lead (Pb) finish with 100% copper core (available with "H" designation code with C-Spec).

Contact KEMET for C-Spec details.

Applications

Typical applications include decoupling, bypass, filtering and transient voltage suppression.

Application Notes

These devices are not recommended for use in overmold applications and/or processes.

Dimensions – Inches (Millimeters)

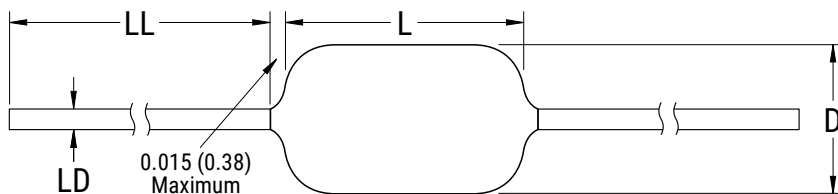

| Series | Style/ Size | L Length Maximum | D Diameter Maximum | LD Lead Diameter | LL Lead Length Minimum |
|--------|----------------|------------------------|--------------------------|---|------------------------------|
| C41X | 410 | 0.170 (4.32) | 0.095 (2.41) | 0.020+0.001/-0.003 (0.51+0.025/-0.076) | 1.0 (25.4) |
| | 412 | 0.170 (4.32) | 0.120 (3.05) | | |
| C42X | 420 | 0.200 (5.08) | 0.100 (2.54) | | |
| C43X | 430 | 0.240 (6.10) | 0.150 (3.81) | | |
| C44X | 440 | 0.260 (6.60) | 0.150 (3.81) | | |

Qualification/Certification

Commercial Grade products are subject to internal qualification. Details regarding test methods and conditions are referenced in Table 2, Performance & Reliability.

Environmental Compliance

Lead (Pb)-free, REACH and RoHS compliant without exemptions when ordered with a 100% tin (Sn) wire lead finish. Product ordered with tin/ lead (Sn60/Pb40) wire lead finish do not meet RoHS criteria.

| Series | Termination Finish (Wire Lead) | RoHS Compliant | RoHS Exemption Code | REACH Compliant ¹ | Halogen Free |
|------------|--------------------------------|----------------|---------------------|------------------------------|--------------|
| 400 (C4XX) | 100% Matte Sn | Yes | n/a | Yes | Yes |
| | Sn60/Pb40 | No | n/a | Yes | Yes |

¹ REACH compliance indicates product does not contain Substance/s of Very High Concern (SVHC)

Electrical Parameters/Characteristics

| Item | Parameters/Characteristics |
|--|--|
| Operating Temperature Range | -55°C to +125°C |
| Capacitance Change with Reference to +25°C and 0 VDC Applied (TCC) | ±15% |
| Aging Rate (Maximum % Cap Loss/Decade Hour) | 3.0% |
| Dielectric Withstanding Voltage | 250% of rated voltage (5±1 second and charge/discharge not exceeding 50 mA at 25°C) |
| Dissipation Factor (DF) Maximum Limit at 25°C | See Dissipation Factor Limit Table |
| Insulation Resistance (IR) Limit at 25°C | See Insulation Resistance Limit Table (Rated voltage applied for 120±5 seconds at 25°C) |

Regarding aging rate: Capacitance measurements (including tolerance) are indexed to a referee time of 1,000 hours.

To obtain IR limit, divide $M\Omega \cdot \mu F$ value by the capacitance and compare to $G\Omega$ limit. Select the lower of the two limits.

Capacitance and dissipation factor (DF) measured under the following conditions:

1 kHz ±50 Hz and $1.0 \pm 0.2 V_{rms}$ if capacitance ≤ 10 μF

120 Hz ±10 Hz and $0.5 \pm 0.1 V_{rms}$ if capacitance > 10 μF

Note: When measuring capacitance it is important to ensure the set voltage level is held constant. The HP4284 and Agilent E4980 have a feature known as Automatic Level Control (ALC). The ALC feature should be switched to "ON."

Insulation Resistance Limit Table

| Style/Size | 1,000 megohm microfarads or 100GΩ | 500 megohm microfarads or 10GΩ |
|------------|--------------------------------------|-----------------------------------|
| 410 | < 0.15μF | ≥ 0.15μF |
| 412 | < 0.15μF | ≥ 0.15μF |
| 420 | < 0.47μF | ≥ 0.47μF |
| 430 | < 0.47μF | ≥ 0.47μF |
| 440 | < 0.47μF | ≥ 0.47μF |

Post Environmental Limits

| High Temperature Life, Biased Humidity and Storage Life | | | | | |
|---|------------------|-------------------|--------------------------------|-------------------|-----------------------|
| Style/Size | Rated DC Voltage | Capacitance Value | Dissipation Factor (Maximum %) | Capacitance Shift | Insulation Resistance |
| C410 | >25 | < 1.0μF | 3.0 | ± 20% | 10% of Initial Limit |
| | | ≥ 1.0 μF | 20.0 | | |
| | 25 | < 2.2 μF | 5.0 | | |
| | | ≥ 2.2 μF | 20.0 | | |
| C412, C420, C440 | >25 | All | 3.0 | | |
| | 25 | | 5.0 | | |
| C430 | >25 | All | 3.0 | | |
| | 25 | < 10.0μF | 5.0 | | |
| | | ≥ 10.0 μF | 20.0 | | |

Dissipation Factor (DF) Limit Table

| Style/Size | Rated DC Voltage | Rated Capacitance | Dissipation Factor (Maximum %) |
|------------------|------------------|-------------------|--------------------------------|
| C410 | 25 | < 2.2 μF | 3.5 |
| | | ≥ 2.2 μF | 10.0 |
| | > 25 | < 1.0 μF | 2.5 |
| | | ≥ 1.0 μF | 10.0 |
| C412, C420, C440 | 25 | All | 3.5 |
| | > 25 | | 2.5 |
| C430 | 25 | < 10.0 μF | 3.5 |
| | | ≥ 10.0 μF | 10.0 |
| | > 25 | All | 2.5 |

Table 1A – C410 Style/Size, Capacitance Range Waterfall

| C410 Style/Size (0.095" Diameter x 0.170" Length) | | | | | | |
|---|---------------------------------|--|-----|-----|-----|-----|
| Rated Voltage (VDC) | | 25 | 50 | 100 | 200 | 250 |
| Voltage Code | | 3 | 5 | 1 | 2 | A |
| Capacitance | Capacitance Tolerance | Capacitance Code (Available Capacitance) | | | | |
| 10pF | J = ±5% K = ±10% M = ±20% | 100 | 100 | 100 | 100 | 100 |
| 12pF | | 120 | 120 | 120 | 120 | 120 |
| 15pF | | 150 | 150 | 150 | 150 | 150 |
| 18pF | | 180 | 180 | 180 | 180 | 180 |
| 22pF | | 220 | 220 | 220 | 220 | 220 |
| 27pF | | 270 | 270 | 270 | 270 | 270 |
| 33pF | | 330 | 330 | 330 | 330 | 330 |
| 39pF | | 390 | 390 | 390 | 390 | 390 |
| 47pF | | 470 | 470 | 470 | 470 | 470 |
| 56pF | | 560 | 560 | 560 | 560 | 560 |
| 68pF | | 680 | 680 | 680 | 680 | 680 |
| 82pF | | 820 | 820 | 820 | 820 | 820 |
| 100pF | | 101 | 101 | 101 | 101 | 101 |
| 120pF | | 121 | 121 | 121 | 121 | 121 |
| 150pF | | 151 | 151 | 151 | 151 | 151 |
| 180pF | | 181 | 181 | 181 | 181 | 181 |
| 220pF | | 221 | 221 | 221 | 221 | 221 |
| 270pF | | 271 | 271 | 271 | 271 | 271 |
| 330pF | | 331 | 331 | 331 | 331 | 331 |
| 390pF | | 391 | 391 | 391 | 391 | 391 |
| 470pF | | 471 | 471 | 471 | 471 | 471 |
| 560pF | | 561 | 561 | 561 | 561 | 561 |
| 680pF | | 681 | 681 | 681 | 681 | 681 |
| 820pF | | 821 | 821 | 821 | 821 | 821 |
| 1000pF | | 102 | 102 | 102 | 102 | 102 |
| 1200pF | | 122 | 122 | 122 | 122 | 122 |
| 1500pF | | 152 | 152 | 152 | 152 | 152 |
| 1800pF | | 182 | 182 | 182 | 182 | 182 |
| 2200pF | | 222 | 222 | 222 | 222 | 222 |
| 2700pF | | 272 | 272 | 272 | 272 | 272 |
| 3300pF | | 332 | 332 | 332 | 332 | 332 |
| 3900pF | | 392 | 392 | 392 | 392 | 392 |
| 4700pF | | 472 | 472 | 472 | 472 | 472 |
| 5600pF | | 562 | 562 | 562 | 562 | 562 |
| 6800pF | | 682 | 682 | 682 | 682 | 682 |
| 8200pF | | 822 | 822 | 822 | 822 | 822 |
| 0.01μF | | 103 | 103 | 103 | 103 | 103 |
| 0.012μF | | 123 | 123 | 123 | 123 | 123 |
| 0.015μF | | 153 | 153 | 153 | 153 | 153 |
| 0.018μF | | 183 | 183 | 183 | 183 | 183 |
| 0.022μF | | 223 | 223 | 223 | 223 | 223 |
| 0.027μF | | 273 | 273 | 273 | 273 | 273 |
| 0.033μF | | 333 | 333 | 333 | 333 | 333 |
| 0.039μF | | 393 | 393 | 393 | 393 | 393 |
| 0.047μF | | 473 | 473 | 473 | 473 | 473 |
| 0.056μF | 563 | 563 | 563 | 563 | 563 | |
| 0.068μF | 683 | 683 | 683 | 683 | 683 | |
| 0.082μF | 823 | 823 | 823 | 823 | 823 | |
| 0.1μF | 104 | 104 | 104 | 104 | 104 | |
| 0.12μF | 124 | 124 | 124 | 124 | 124 | |
| 0.15μF | 154 | 154 | 154 | 154 | 154 | |
| 0.18μF | 184 | 184 | 184 | 184 | 184 | |
| 0.22μF | 224 | 224 | 224 | 224 | 224 | |
| 0.27μF | 274 | 274 | 274 | 274 | 274 | |
| 0.33μF | 334 | 334 | 334 | 334 | 334 | |
| 0.39μF | 394 | 394 | 394 | 394 | 394 | |
| 0.47μF | 474 | 474 | 474 | 474 | 474 | |
| 0.56μF | 564 | 564 | 564 | 564 | 564 | |
| Rated Voltage (VDC) | | 25 | 50 | 100 | 200 | 250 |
| Voltage Code | | 3 | 5 | 1 | 2 | A |

Table 1A – C410 Style/Size, Capacitance Range Waterfall cont'd

| C410 Style/Size (0.095" Diameter x 0.170" Length) | | | | | | |
|---|---------------------------------|--|-----|-----|-----|-----|
| Rated Voltage (VDC) | | 25 | 50 | 100 | 200 | 250 |
| Voltage Code | | 3 | 5 | 1 | 2 | A |
| Capacitance | Capacitance Tolerance | Capacitance Code (Available Capacitance) | | | | |
| 0.68µF | J = ±5% K = ±10% M = ±20% | 684 | 684 | | | |
| 0.82µF | | 824 | | | | |
| 1.0µF | | 105 | 105 | | | |
| 2.2µF | | 225 | | | | |
| Rated Voltage (VDC) | | 25 | 50 | 100 | 200 | 250 |
| Voltage Code | | 3 | 5 | 1 | 2 | A |

Table 1B – C412 Style/Size, Capacitance Range Waterfall

| C412 Style/Size (0.120" Diameter x 0.170" Length) | | | | | | |
|---|---------------------------------|--|-----|-----|-----|-----|
| Rated Voltage (VDC) | | 25 | 50 | 100 | 200 | 250 |
| Voltage Code | | 3 | 5 | 1 | 2 | A |
| Capacitance | Capacitance Tolerance | Capacitance Code (Available Capacitance) | | | | |
| 470pF | J = ±5% K = ±10% M = ±20% | 471 | 471 | 471 | 471 | 471 |
| 560pF | | 561 | 561 | 561 | 561 | 561 |
| 680pF | | 681 | 681 | 681 | 681 | 681 |
| 820pF | | 821 | 821 | 821 | 821 | 821 |
| 1000pF | | 102 | 102 | 102 | 102 | 102 |
| 1200pF | | 122 | 122 | 122 | 122 | 122 |
| 1500pF | | 152 | 152 | 152 | 152 | 152 |
| 1800pF | | 182 | 182 | 182 | 182 | 182 |
| 2200pF | | 222 | 222 | 222 | 222 | 222 |
| 2700pF | | 272 | 272 | 272 | 272 | 272 |
| 3300pF | | 332 | 332 | 332 | 332 | 332 |
| 3900pF | | 392 | 392 | 392 | 392 | 392 |
| 4700pF | | 472 | 472 | 472 | 472 | 472 |
| 5600pF | | 562 | 562 | 562 | 562 | 562 |
| 6800pF | | 682 | 682 | 682 | 682 | 682 |
| 8200pF | | 822 | 822 | 822 | 822 | 822 |
| 0.01µF | | 103 | 103 | 103 | 103 | 103 |
| 0.012µF | | 123 | 123 | 123 | 123 | 123 |
| 0.015µF | | 153 | 153 | 153 | 153 | 153 |
| 0.018µF | | 183 | 183 | 183 | 183 | 183 |
| 0.022µF | | 223 | 223 | 223 | 223 | 223 |
| 0.027µF | | 273 | 273 | 273 | 273 | 273 |
| 0.033µF | | 333 | 333 | 333 | | |
| 0.039µF | | 393 | 393 | 393 | | |
| 0.047µF | | 473 | 473 | 473 | | |
| 0.056µF | | 563 | 563 | 563 | | |
| 0.068µF | | 683 | 683 | 683 | | |
| 0.082µF | | 823 | 823 | 823 | | |
| 0.1µF | | 104 | 104 | 104 | | |
| 0.12µF | | 124 | 124 | 124 | | |
| 0.15µF | | 154 | 154 | 154 | | |
| 0.18µF | | 184 | 184 | 184 | | |
| 0.22µF | | 224 | 224 | 224 | | |
| 0.27µF | | 274 | 274 | | | |
| 0.33µF | | 334 | 334 | | | |
| 0.39µF | | 394 | 394 | | | |
| 0.47µF | | 474 | 474 | | | |
| 0.56µF | | 564 | 564 | | | |
| 0.68µF | | 684 | 684 | | | |
| 0.82µF | | 824 | | | | |
| 1.0µF | 105 | | | | | |
| Rated Voltage (VDC) | | 25 | 50 | 100 | 200 | 250 |
| Voltage Code | | 3 | 5 | 1 | 2 | A |

Table 1C – C420 Style/Size, Capacitance Range Waterfall

| C420 Style/Size (0.100" Diameter x 0.200" Length) | | | | | | |
|---|---------------------------------|--|-----|-----|-----|-----|
| Rated Voltage (VDC) | | 25 | 50 | 100 | 200 | 250 |
| Voltage Code | | 3 | 5 | 1 | 2 | A |
| Capacitance | Capacitance Tolerance | Capacitance Code (Available Capacitance) | | | | |
| 470pF | J = ±5% K = ±10% M = ±20% | 471 | 471 | 471 | 471 | 471 |
| 560pF | | 561 | 561 | 561 | 561 | 561 |
| 680pF | | 681 | 681 | 681 | 681 | 681 |
| 820pF | | 821 | 821 | 821 | 821 | 821 |
| 1000pF | | 102 | 102 | 102 | 102 | 102 |
| 1200pF | | 122 | 122 | 122 | 122 | 122 |
| 1500pF | | 152 | 152 | 152 | 152 | 152 |
| 1800pF | | 182 | 182 | 182 | 182 | 182 |
| 2200pF | | 222 | 222 | 222 | 222 | 222 |
| 2700pF | | 272 | 272 | 272 | 272 | 272 |
| 3300pF | | 332 | 332 | 332 | 332 | 332 |
| 3900pF | | 392 | 392 | 392 | 392 | 392 |
| 4700pF | | 472 | 472 | 472 | 472 | 472 |
| 5600pF | | 562 | 562 | 562 | 562 | 562 |
| 6800pF | | 682 | 682 | 682 | 682 | 682 |
| 8200pF | | 822 | 822 | 822 | 822 | 822 |
| 0.01μF | | 103 | 103 | 103 | 103 | 103 |
| 0.012μF | | 123 | 123 | 123 | 123 | 123 |
| 0.015μF | | 153 | 153 | 153 | 153 | 153 |
| 0.018μF | | 183 | 183 | 183 | 183 | 183 |
| 0.022μF | | 223 | 223 | 223 | 223 | 223 |
| 0.027μF | | 273 | 273 | 273 | 273 | 273 |
| 0.033μF | | 333 | 333 | 333 | 333 | 333 |
| 0.039μF | | 393 | 393 | 393 | 393 | 393 |
| 0.047μF | | 473 | 473 | 473 | 473 | 473 |
| 0.056μF | | 563 | 563 | 563 | 563 | 563 |
| 0.068μF | | 683 | 683 | 683 | 683 | 683 |
| 0.082μF | | 823 | 823 | 823 | 823 | 823 |
| 0.1μF | | 104 | 104 | 104 | 104 | 104 |
| 0.12μF | | 124 | 124 | 124 | | |
| 0.15μF | | 154 | 154 | 154 | | |
| 0.18μF | | 184 | 184 | 184 | | |
| 0.22μF | | 224 | 224 | 224 | | |
| 0.27μF | | 274 | 274 | 274 | | |
| 0.33μF | | 334 | 334 | 334 | | |
| 0.39μF | | 394 | 394 | 394 | | |
| 0.47μF | | 474 | 474 | 474 | | |
| 0.56μF | | 564 | 564 | | | |
| 0.68μF | | 684 | 684 | | | |
| 0.82μF | | 824 | 824 | | | |
| 1.0μF | 105 | 105 | | | | |
| Rated Voltage (VDC) | | 25 | 50 | 100 | 200 | 250 |
| Voltage Code | | 3 | 5 | 1 | 2 | A |

Table 1D – C430 Style/Size, Capacitance Range Waterfall

| C430 Style/Size (0.150" Diameter x 0.240" Length) | | | | | | |
|---|---------------------------------|--|-----|-----|-----|-----|
| Rated Voltage (VDC) | | 25 | 50 | 100 | 200 | 250 |
| Voltage Code | | 3 | 5 | 1 | 2 | A |
| Capacitance | Capacitance Tolerance | Capacitance Code (Available Capacitance) | | | | |
| 0.022µF | J = ±5% K = ±10% M = ±20% | 223 | 223 | 223 | 223 | 223 |
| 0.027µF | | 273 | 273 | 273 | 273 | 273 |
| 0.033µF | | 333 | 333 | 333 | 333 | 333 |
| 0.039µF | | 393 | 393 | 393 | 393 | 393 |
| 0.047µF | | 473 | 473 | 473 | 473 | 473 |
| 0.056µF | | 563 | 563 | 563 | 563 | 563 |
| 0.068µF | | 683 | 683 | 683 | 683 | 683 |
| 0.082µF | | 823 | 823 | 823 | 823 | 823 |
| 0.1µF | | 104 | 104 | 104 | 104 | 104 |
| 0.12µF | | 124 | 124 | 124 | 124 | 124 |
| 0.15µF | | 154 | 154 | 154 | 154 | 154 |
| 0.18µF | | 184 | 184 | 184 | | |
| 0.22µF | | 224 | 224 | 224 | | |
| 0.27µF | | 274 | 274 | 274 | | |
| 0.33µF | | 334 | 334 | 334 | | |
| 0.39µF | | 394 | 394 | 394 | | |
| 0.47µF | | 474 | 474 | 474 | | |
| 0.56µF | | 564 | 564 | | | |
| 0.68µF | | 684 | 684 | | | |
| 0.82µF | | 824 | 824 | | | |
| 1.0µF | | 105 | 105 | | | |
| 1.2µF | | 125 | 125 | | | |
| 1.5µF | | 155 | 155 | | | |
| 1.8µF | | 185 | 185 | | | |
| 2.0µF | | 205 | 205 | | | |
| 2.2µF | | 225 | 225 | | | |
| 2.7µF | | 275 | | | | |
| 3.3µF | | 335 | | | | |
| 3.9µF | 395 | | | | | |
| 4.7µF | 475 | | | | | |
| 10µF | 106* | | | | | |
| Rated Voltage (VDC) | | 25 | 50 | 100 | 200 | 250 |
| Voltage Code | | 3 | 5 | 1 | 2 | A |

* Only available on K and M tolerances.

Table 1E – C440 Style/Size, Capacitance Range Waterfall

| C440 Style/Size (0.150" Diameter x 0.260" Length) | | | | | | |
|---|---------------------------------|--|-----|-----|-----|-----|
| Rated Voltage (VDC) | | 25 | 50 | 100 | 200 | 250 |
| Voltage Code | | 3 | 5 | 1 | 2 | A |
| Capacitance | Capacitance Tolerance | Capacitance Code (Available Capacitance) | | | | |
| 0.033µF | J = ±5% K = ±10% M = ±20% | 333 | 333 | 333 | 333 | 333 |
| 0.039µF | | 393 | 393 | 393 | 393 | 393 |
| 0.047µF | | 473 | 473 | 473 | 473 | 473 |
| 0.056µF | | 563 | 563 | 563 | 563 | 563 |
| 0.068µF | | 683 | 683 | 683 | 683 | 683 |
| 0.082µF | | 823 | 823 | 823 | 823 | 823 |
| 0.1µF | | 104 | 104 | 104 | 104 | 104 |
| 0.12µF | | 124 | 124 | 124 | 124 | 124 |
| 0.15µF | | 154 | 154 | 154 | | |
| 0.18µF | | 184 | 184 | 184 | | |
| 0.22µF | | 224 | 224 | 224 | | |
| 0.27µF | | 274 | 274 | 274 | | |
| 0.33µF | | 334 | 334 | 334 | | |
| 0.39µF | | 394 | 394 | 394 | | |
| 0.47µF | | 474 | 474 | 474 | | |
| 0.56µF | | 564 | 564 | | | |
| 0.68µF | | 684 | 684 | | | |
| 0.82µF | | 824 | 824 | | | |
| 1.0µF | | 105 | 105 | | | |
| 1.2µF | | 125 | 125 | | | |
| 1.5µF | | 155 | 155 | | | |
| 1.8µF | | 185 | 185 | | | |
| 2.0µF | | 205 | 205 | | | |
| 2.2µF | | 225 | 225 | | | |
| 2.7µF | | 275 | | | | |
| 3.3µF | 335 | | | | | |
| 3.9µF | 395 | | | | | |
| 4.7µF | 475 | | | | | |
| Rated Voltage (VDC) | | 25 | 50 | 100 | 200 | 250 |
| Voltage Code | | 3 | 5 | 1 | 2 | A |

Soldering Process

Recommended Soldering Methods:

- Solder Wave
- Hand Soldering (Manual)

Recommended Soldering Profile:

- Optimum Wave Solder Profile

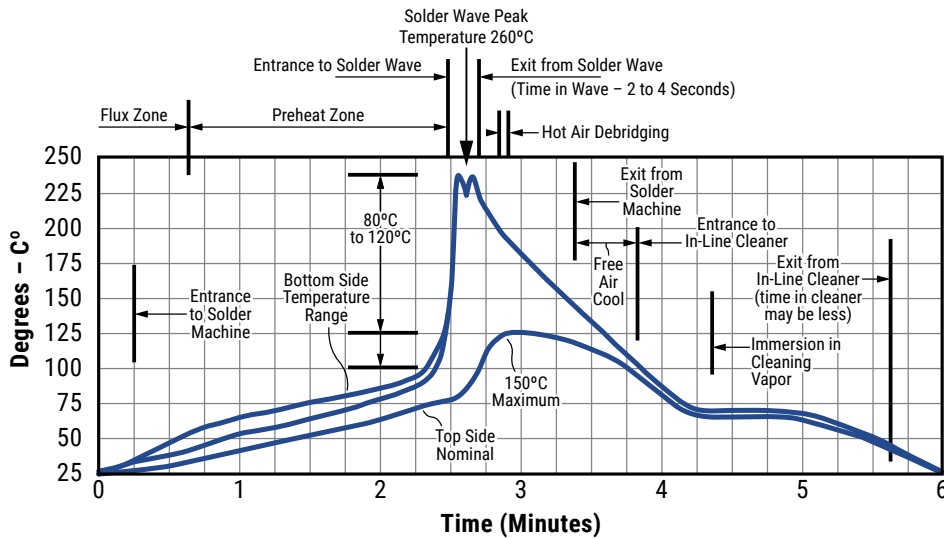

Mounting

All encased capacitors will pass the Resistance to Soldering Heat of MIL-STD-202, Method 210, Condition C. This test simulates wave solder topside board mount product. This demonstration of resistance to solder heat is in accordance with what is believed to be the industry standard. More severe treatment must be considered reflective of an improper soldering process.

The above figure is a recommended solder wave profile for both axial and radial leaded ceramic capacitors.

- Hand Soldering (Manual)

Manual Solder Profile with Pre-heating

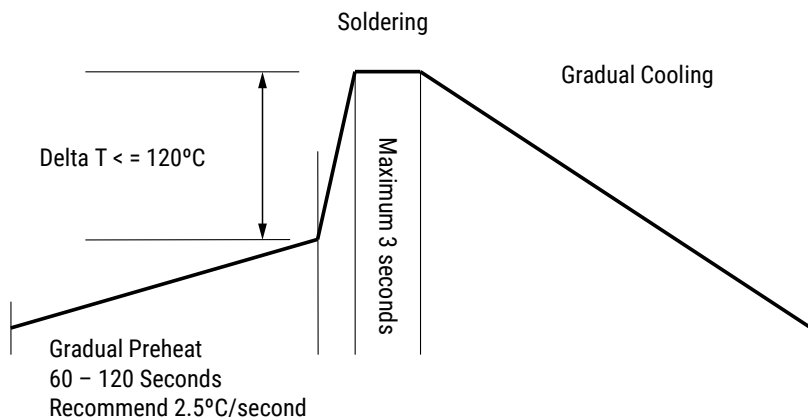

Table 2 – Performance & Reliability: Test Methods and Conditions

| Stress | Reference | Test or Inspection Method |
|------------------------------|-----------------------------------|---|
| Solderability | J-STD-002 | Magnification 50X. Conditions: a) Method A, at 235°C, Category 3 |
| Temperature Cycling | JESD22 Method JA-104 | 5 cycles (-55°C to +125°C), measurement at 24 hours +/-4 hours after test conclusion. |
| Biased Humidity | MIL-STD-202 Method 103 | Load humidity, 1,000 hours 85°C/85%RH and rated voltage. Add 100 K ohm resistor. Measurement at 24 hours +/-4 hours after test conclusion. |
| | | Low volt humidity, 1,000 hours 85°C/85%RH and 1.5 V. Add 100 K ohm resistor. Measurement at 24 hours +/-4 hours after test conclusion. |
| Moisture Resistance | MIL-STD-202 Method 106 | t = 24 hours/cycle. Steps 7a & 7b not required. Unpowered. Measurement at 24 hours +/-4 hours after test conclusion. |
| Thermal Shock | MIL-STD-202 Method 107 | -55°C to +125°C. Note: Number of cycles required = 300. Maximum transfer time = 20 seconds. Dwell time -15 minutes. Air – Air. |
| High Temperature Life | MIL-STD-202 Method 108 / EIA -198 | 1,000 hours at 125°C (85°C for Z5U) with 1 X rated voltage applied. |
| Storage Life | MIL-STD-202 Method 108 | 125°C, 0 VDC for 1,000 hours. |
| Vibration | MIL-STD-202 Method 204 | 5 g for 20 minutes, 12 cycles each of 3 orientations. Note: Use 8"X5" PCB .031" thick 7 secure points on one long side and 2 secure points at corners of opposite sides. Parts mounted within 2" from any secure point. Test from 10-2000 Hz. |
| Resistance to Soldering Heat | MIL-STD-202 Method 210 | Condition B. No preheat of samples. Note: single wave solder – procedure 2. |
| Terminal Strength | MIL-STD-202 Method 211 | Conditions A (454g), Condition C (227g) |
| Mechanical Shock | MIL-STD-202 Method 213 | Figure 1 of Method 213, Condition C. |
| Resistance to Solvents | MIL-STD-202 Method 215 | Add aqueous wash chemical – OKEM Clean or equivalent. |

Storage & Handling

The un-mounted storage life of a leaded ceramic capacitor is dependent upon storage and atmospheric conditions as well as packaging materials. While the ceramic chips enveloped under the epoxy coating themselves are quite robust in most environments, solderability of the wire lead on the final epoxy-coated product will be degraded by exposure to high temperatures, high humidity, corrosive atmospheres, and long term storage. In addition, packaging materials will be degraded by high temperature and exposure to direct sunlight—reels may soften or warp, and tape peel force may increase.

KEMET recommends storing the un-mounted capacitors in their original packaging, in a location away from direct sunlight, and where the temperature and relative humidity do not exceed 40 degrees centigrade and 70% respectively. For optimum solderability, capacitor stock should be used promptly, preferably within 18 months of receipt. For applications requiring pre-tinning of components, storage life may be extended if solderability is verified. Before cleaning, bonding or molding these devices, it is important to verify that your process does not affect product quality and performance. KEMET recommends testing and evaluating the performance of a cleaned, bonded or molded product prior to implementing and/or qualifying any of these processes.

Construction

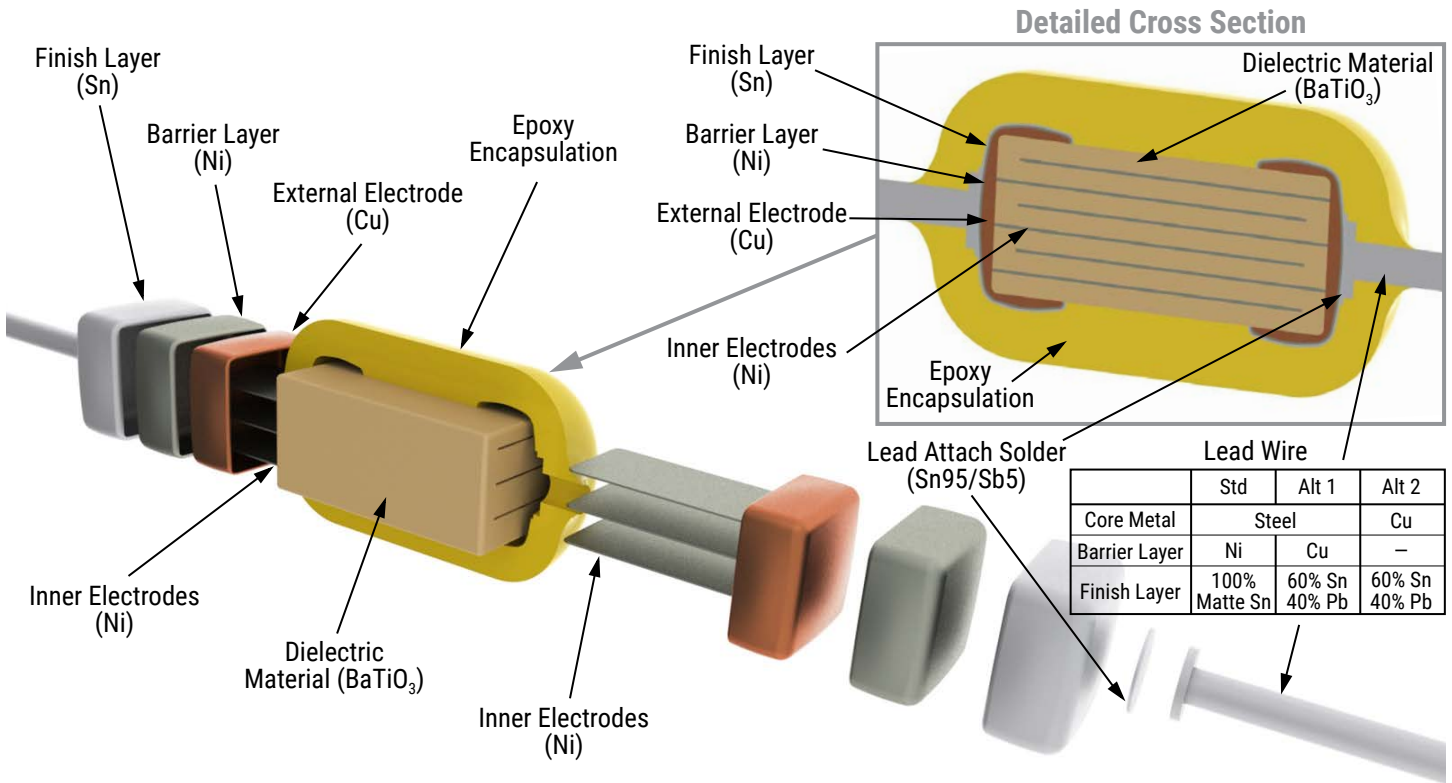

Marking

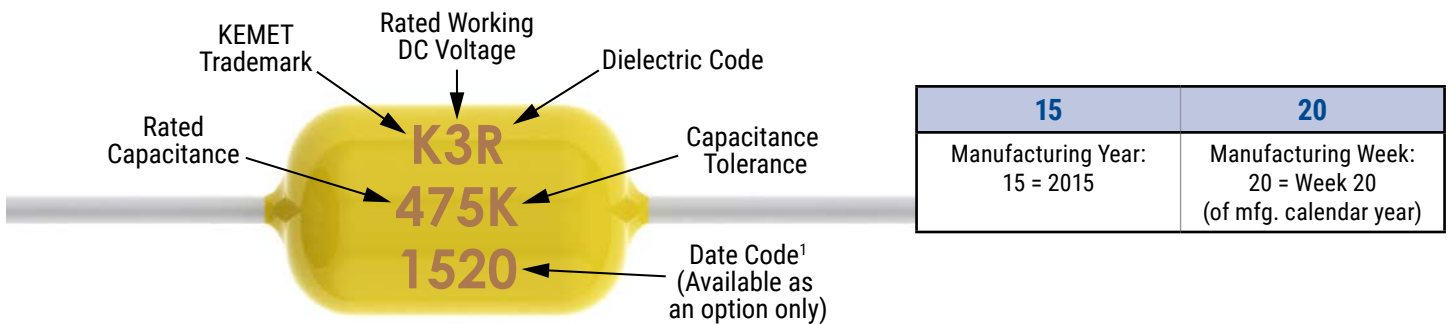

¹ To properly request the inclusion of the date code in the marking, ordering code please contact your KEMET representative.

Packaging Quantities

| Style/Size | Standard Bulk Quantity | Ammo Pack Quantity Maximum | Reel Quantity Maximum (12" Reel) |
|------------|------------------------|----------------------------|----------------------------------|
| 410 | 300/Box | 4000 | 5000 |
| 412 | 200/Box | | |
| 420 | 300/Box | | |
| 430 | 200/Box | 2000 | 2500 |
| 440 | 200/Box | | |

Tape & Reel Packaging Information

KEMET offers standard reeling of molded and conformally coated axial leaded ceramic capacitors for automatic insertion or lead forming machines in accordance with EIA standard 296. KEMET’s internal specification four-digit suffix, 7200, is placed at the end of the part number to designate tape and reel packaging, e.g., C410C104Z5U5CA7200.

Paper (50 lb.) test minimum is inserted between the layers of capacitors wound on reels for component pitch $\leq 0.400"$. Capacitor lead length may extend only a maximum of $.0625"$ (1.59 mm) beyond the tapes’ edges. Capacitors are centered in a row between the two tapes and will deviate only $\pm 0.031"$ (0.79 mm) from the row center. A minimum of 36" (91.5 cm) leader tape is provided at each finished length of taped components. Universal splicing clips are used to connect the tape.

Figure 1

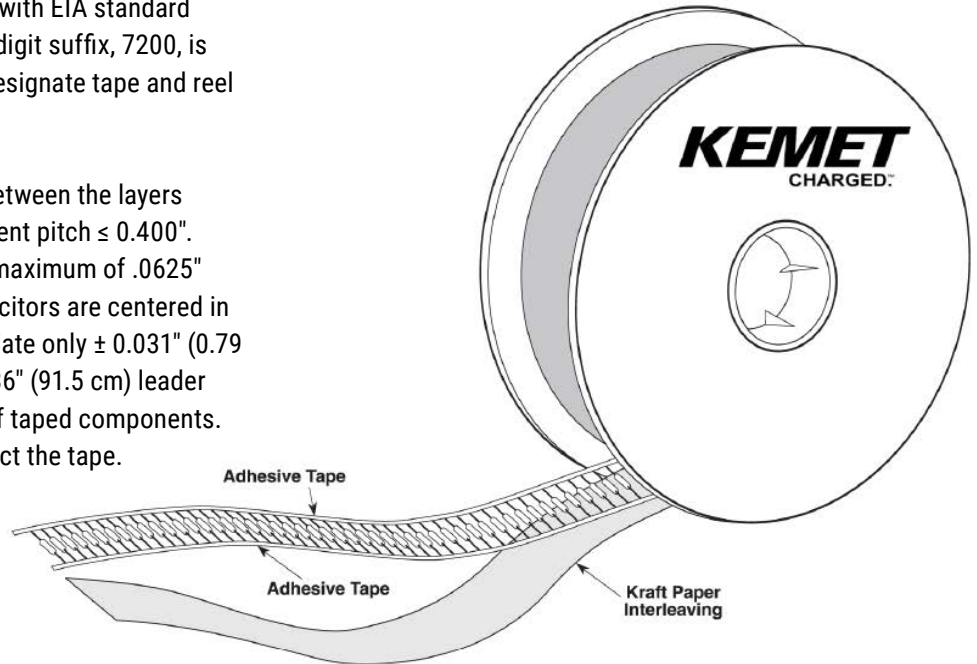

Figure 2

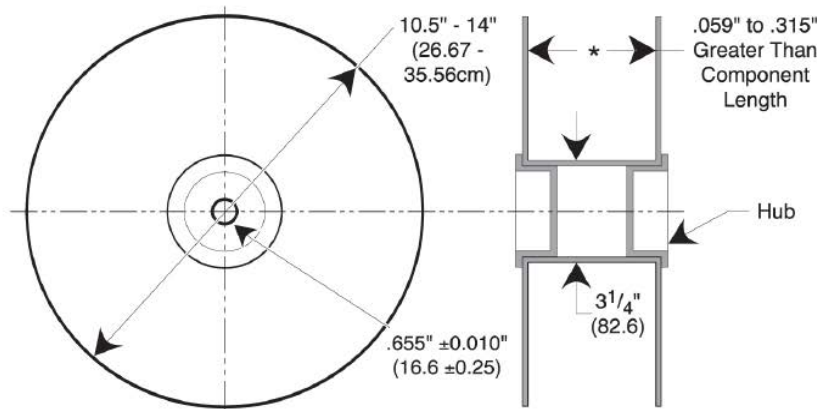

Figure 3

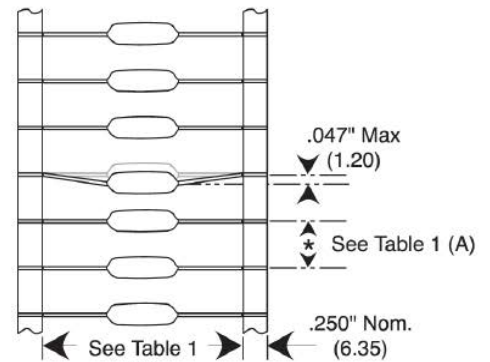

Table 3 – Ceramic Axial Tape and Reel Dimensions

Metric will govern

| Dimensions – Millimeters (Inches) | | |
|-----------------------------------|-------------------|--------------------|
| Axial Capacitor Body Diameter | A | B |
| ± 0.5 (0.020) | ± 0.5 (0.020) | ± 1.5 (0.059)* |
| 0.0 to 5.0 (0.0 to 0.197) | 5.0 (0.197) | 52.4 (2.062) |

| Symbol Reference Table | |
|------------------------|---------------------|
| A | Component Pitch |
| B | Inside Tape Spacing |

* Inside tape spacing dimension (B) is determined by the body diameter of the capacitor.

KEMET Electronics Corporation Sales Offices

For a complete list of our global sales offices, please visit www.kemet.com/sales.

Disclaimer

All product specifications, statements, information and data (collectively, the "Information") in this datasheet are subject to change. The customer is responsible for checking and verifying the extent to which the Information contained in this publication is applicable to an order at the time the order is placed.

All Information given herein is believed to be accurate and reliable, but it is presented without guarantee, warranty, or responsibility of any kind, expressed or implied.

Statements of suitability for certain applications are based on KEMET Electronics Corporation's ("KEMET") knowledge of typical operating conditions for such applications, but are not intended to constitute – and KEMET specifically disclaims – any warranty concerning suitability for a specific customer application or use. The Information is intended for use only by customers who have the requisite experience and capability to determine the correct products for their application. Any technical advice inferred from this Information or otherwise provided by KEMET with reference to the use of KEMET's products is given gratis, and KEMET assumes no obligation or liability for the advice given or results obtained.

Although KEMET designs and manufactures its products to the most stringent quality and safety standards, given the current state of the art, isolated component failures may still occur. Accordingly, customer applications which require a high degree of reliability or safety should employ suitable designs or other safeguards (such as installation of protective circuitry or redundancies) in order to ensure that the failure of an electrical component does not result in a risk of personal injury or property damage.

Although all product-related warnings, cautions and notes must be observed, the customer should not assume that all safety measures are indicated or that other measures may not be required.

Mouser Electronics

Authorized Distributor

Click to View Pricing, Inventory, Delivery & Lifecycle Information:

KEMET:

[C412C223K1R5TA](#) [C410C223K5R5TA](#) [C410C332K1R5TA](#) [C410C102K5R5HATR](#) [C410C472K1R5TA](#)
[C410C222K5R5TATR](#) [C410C222J1R5TA](#) [C430C224K5R5HA](#) [C420C223K1R5TA7200](#) [C410C682K1R5HATR](#)
[C430C154K5R5HA](#) [C412C683K5R5TATR](#) [C430C124K5R5TA](#) [C410C392K1R5TA](#) [C430C124K5R5TA7200](#)
[C430C104K5R5TA7200](#) [C430C154K5R5TA7200](#) [C412C683M5R5TATR](#) [C410C333K5R5HA7200](#) [C410C223J5R5TA](#)
[C410C332J1R5TA](#) [C410C472J1R5TA](#) [C410C393K5R5TA](#) [C430C154K5R5TA](#) [C430C104K1R5TA7200](#)
[C410C222M1R5TA](#) [C410C392J1R5TA](#) [C420C223K1R5TA](#) [C410C102M1R5HATR](#) [C420C104K5R5TA7200](#)
[C410C392K1R5TA7200](#) [C410C332K1R5TA7200](#) [C412C104J5R5HA](#) [C420C563K5R5TA7200](#) [C410C152K1R5HA](#)
[C410C102K1R5HA](#) [C410C103K1R5HA](#) [C410C182K1R5HA](#) [C410C561K1R5TA7200](#) [C410C562K1R5TA7200](#)
[C412C104J5R5TA7200](#) [C410C681K1R5TA](#) [C420C683K5R5TA](#) [C410C473M5R5TA](#) [C410C223M5R5TA](#)
[C410C182K1R5TA7200](#) [C410C103K1R5TA7200](#) [C410C102K1R5TA7200](#) [C410C123K1R5TA7200](#)
[C410C122K1R5TA7200](#) [C410C152K1R5TA7200](#) [C410C822K1R5TA7200](#) [C410C821K1R5TA7200](#)
[C420C683K5R5TA7200](#) [C430C473K1R5TA](#) [C410C682K1R5HA](#) [C410C472K1R5TA7200](#) [C410C471K1R5TA7200](#)
[C410C333K5R5TA](#) [C410C222K1R5TA7200](#) [C410C472K1R5HA](#) [C410C471K1R5HA](#) [C410C272K1R5TA7200](#)
[C410C222K1R5TA](#) [C410C821K1R5HA](#) [C430C683K1R5TA](#) [C410C473K5R5TA](#) [C410C682K1R5TA7200](#)
[C410C681K1R5TA7200](#) [C430C224K5R5TA7200](#) [C430C274K5R5TA7200](#) [C410C183J5R5TA](#) [C440C274K5R5TA](#)
[C410C471K1R5TA](#) [C410C182K1R5TA](#) [C430C274K5R5TA](#) [C410C222K1R5HATR](#) [C410C822K1R5TA](#)
[C410C103M5R5HATR](#) [C410C103M1R5HATR](#) [C430C473K1R5HA](#) [C430C683K1R5TA7200](#) [C410C183K5R5TA](#)
[C410C103K1R5HATR](#) [C430C473K1R5TA7200](#) [C430C104K1R5HA](#) [C410C222M1R5HA](#) [C430C104M1R5TA](#)
[C412C104M5R5TA](#) [C410C222M1R5TA7200](#) [C410C273K5R5TA](#) [C430C104K5R5TA](#) [C430C104K1R5TA](#)
[C440C104K1R5TA7200](#) [C412C223K1R5TA7200](#) [C420C823K5R5TA](#) [C412C104K5R5TA](#) [C410C821K1R5TA](#)
[C420C104M5R5TA7200](#) [C440C104K1R5TA](#)