

ADJUSTABLE LOW DROPOUT VOLTAGE REGULATOR

■ GENERAL DESCRIPTION

The NJM2387/89 are adjustable low dropout voltage regulators .
 The output current is up to 1.0A and dropout voltage is 0.2V typ. at $I_o=0.5A$. NJM2387 has ON/OFF control circuit and enable to reduce quiescent current.
 The NJM2387/89 are suitable for power module, TV, Display, car stereo and low power applications.

■ PACKAGE OUTLINE

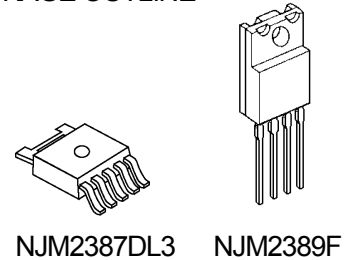

■ FEATURE

- Low Dropout Voltage $\Delta V_{I-O}=0.2V$ typ. at $I_o=0.5A$
- Output Current $I_o(max.)=1.0A$
- Reference Voltage $V_{ref}=1.26V \pm 2\%$
- ON/OFF Control (Active High : Only NJM2387)
- Internal Short Circuit Current Limit
- Internal Overvoltage Protection
- Internal Thermal Overload Protection
- Bipolar Technology
- Package Outline TO-252-5(NJM2387), TO-220F-4(NJM2389)

■ PIN CONFIGURATION

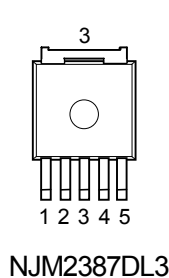

- PIN FUNCTION**
1. V_{IN}
 2. ON/OFF CONTROL
 3. V_{OUT}
 4. V_{ADJ}
 5. GND

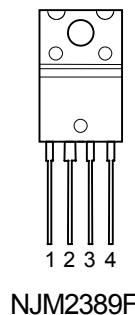

- PIN FUNCTION**
1. V_{IN}
 2. V_{OUT}
 3. GND
 4. V_{ADJ}

■ EQUIVALENT CIRCUIT

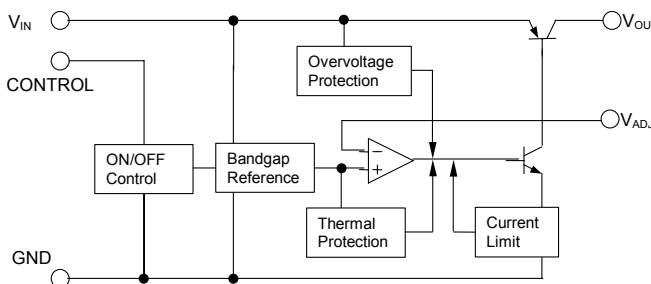

NJM2387DL3

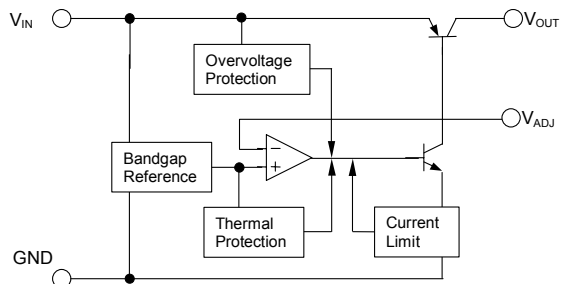

NJM2389F

NJM2387/89

■ ABSOLUTE MAXIMUM RATINGS

(Ta=25°C)

PARAMETER	SYMBOL	RATINGS		UNIT
Input Voltage	V _{IN}	+35		V
Control Voltage	V _{CONT}	+35(*1)		V
Adjust Terminal Voltage	V _{ADJ}	+6		V
Output Current	I _O	1.0		A
Power Dissipation	P _D	NJM2387	10(T _C ≤25°C) / 1(T _a ≤25°C)	W
		NJM2389	18(T _C <50°C)	
Operating Junction Temperature Range	T _J	-40 ~ +150		°C
Operating Temperature Range	T _{opr}	-40 ~ +85		°C
Storage Temperature Range	T _{stg}	-50 ~ +150		°C

(*1): This applies for NJM2387. When input voltage is less than +35V, the absolute maximum control voltage is equal to the input voltage.

■ NJM2387

■ ELECTRICAL CHARACTERISTICS (V_{IN}=15V, V_O=10V, I_O=0.5A, R₁=1kΩ, C_{IN}=0.33μF, C_O=22μF, Ta=25°C)

Measurement is to be conducted is pulse testing.

PARAMETER	SYMBOL	CONDITIONS	MIN.	TYP.	MAX.	UNIT
Input Voltage	V _{IN}	-	3.8	-	35	V
Output Voltage	V _{OUT}	-	1.5	-	20	V
Reference Voltage	V _{ref}	-	1.235	1.26	1.285	V
Line Regulation	ΔV _O /ΔV _{IN}	V _{IN} =V _O +1V ~ V _O +17V	-	0.04	0.16	%/V
Load Regulation	ΔV _O /ΔI _O	V _{IN} =V _O +2V, I _O =0A ~ 1.0A	-	0.2	1.4	%/A
Average Temperature Coefficient of Output Voltage	ΔV _O /ΔT	T _J =0 ~ +125°C	-	±0.02	-	%/°C
Quiescent Current	I _Q	I _O =0A	-	-	5	mA
Dropout Voltage	ΔV _{LO}	I _O =0.5A	-	0.2	0.5	V
Ripple Rejection	RR	V _{in} =V _O +2V, e _{in} =0.5Vrms e _{in} =0.5Vrms, f=120Hz	52	65	-	dB
ON Control Voltage	V _{CONT(ON)}		2.0(*2)	-	-	V
OFF Control Voltage	V _{CONT(OFF)}		-	-	0.4	V
ON Control Current	I _{CONT(ON)}	V _C =2.7V	-	-	20	μA
OFF Control Current	I _{CONT(OFF)}	V _C =0.4V	-	-	-20	μA

(*2): When ON/OFF CONTROL Terminal is open, Output Voltage is ON.

■ POWER DISSIPATION vs. AMBIENT TEMPERATURE

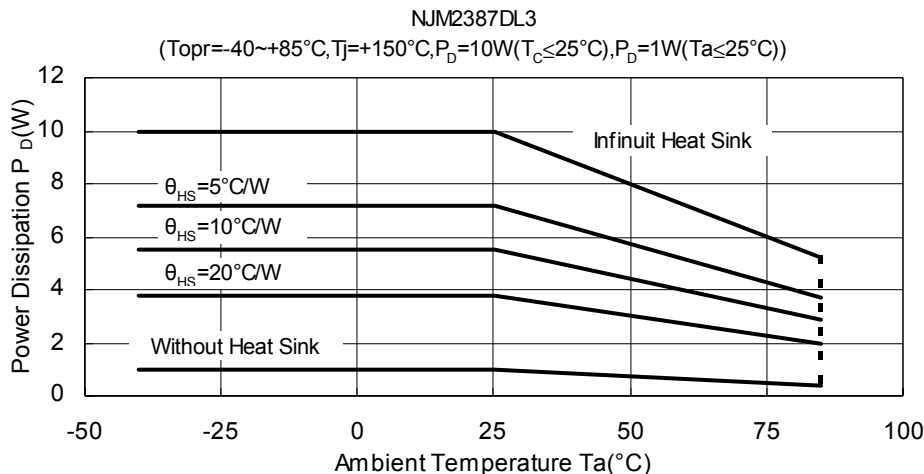

■ TEST CIRCUIT

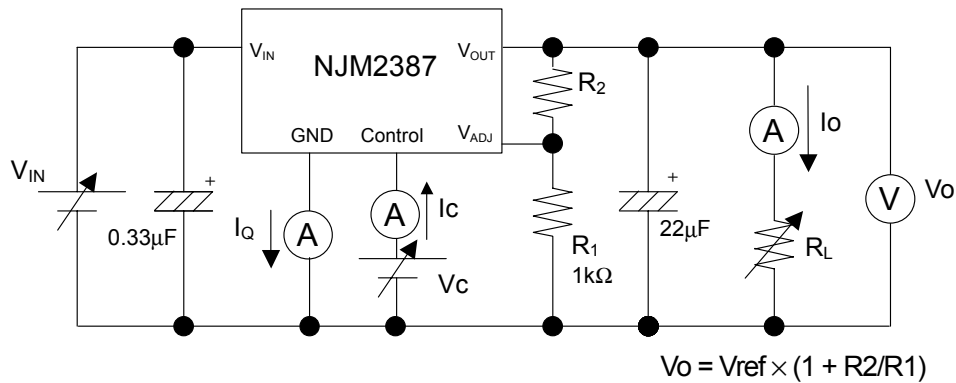

■ TYPICAL APPLICATION

① In the case where ON/OFF Control is not required:

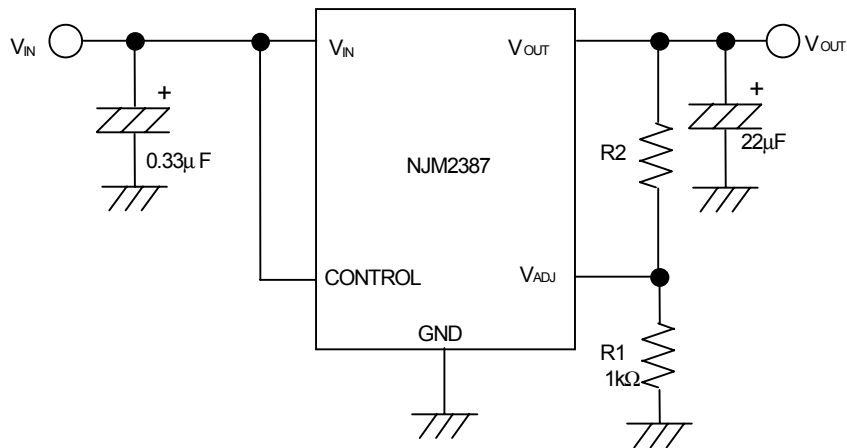

Connect control terminal to V_{IN} terminal or open.

② In use of ON/OFF CONTROL:

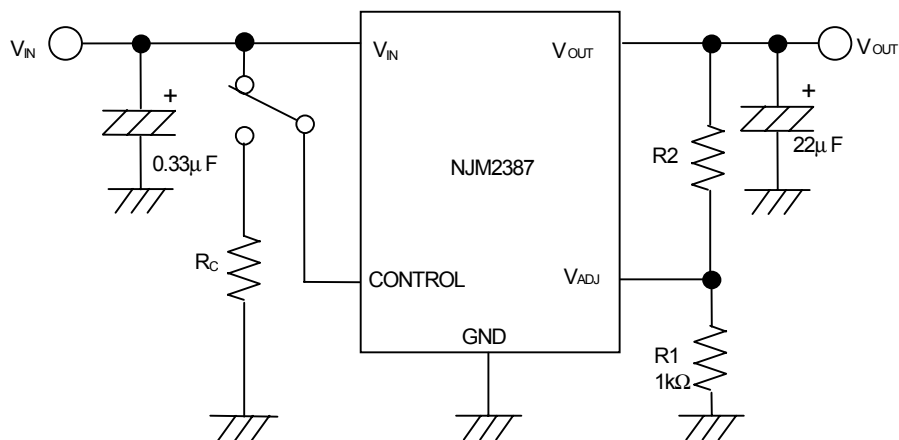

State of control terminal:

- “H” or “open” → output is enabled.
- “L” → output is disabled.

NJM2387/89

■ NJM2389

■ ELECTRICAL CHARACTERISTICS ($V_{IN}=15V$, $V_O=10V$, $I_o=0.5A$, $R_1=1k\Omega$, $C_{IN}=0.33\mu F$, $C_o=22\mu F$, $T_a=25^\circ C$)

Measurement is to be conducted is pulse testing.

PARAMETER	SYMBOL	CONDITIONS	MIN.	TYP.	MAX.	UNIT
Input Voltage	V_{IN}	-	3.8	-	35	V
Output Voltage	V_{OUT}	-	1.5	-	20	V
Reference Voltage	V_{ref}	-	1.235	1.26	1.285	V
Line Regulation	$\Delta V_o/\Delta V_{IN}$	$V_{IN}=V_o+1V \sim V_o+17V$	-	0.04	0.16	%/V
Load Regulation	$\Delta V_o/\Delta I_o$	$V_{IN}=V_o+2V, I_o=0A \sim 1.0A$	-	0.2	1.4	%/A
Average Temperature Coefficient of Output Voltage	$\Delta V_o/\Delta T$	$T_j=0 \sim +125^\circ C$	-	± 0.02	-	%/°C
Quiescent Current	I_Q	$I_o=0A$	-	-	5	mA
Dropout Voltage	$\Delta V_{L.O}$	$I_o=0.5A$	-	0.2	0.5	V
Ripple Rejection	RR	$V_{in}=V_o+2V$, $e_{in}=0.5V_{rms}$ $e_{in}=0.5V_{rms}$, $f=120Hz$	52	65	-	dB

■ POWER DISSIPATION vs. AMBIENT TEMPERATURE

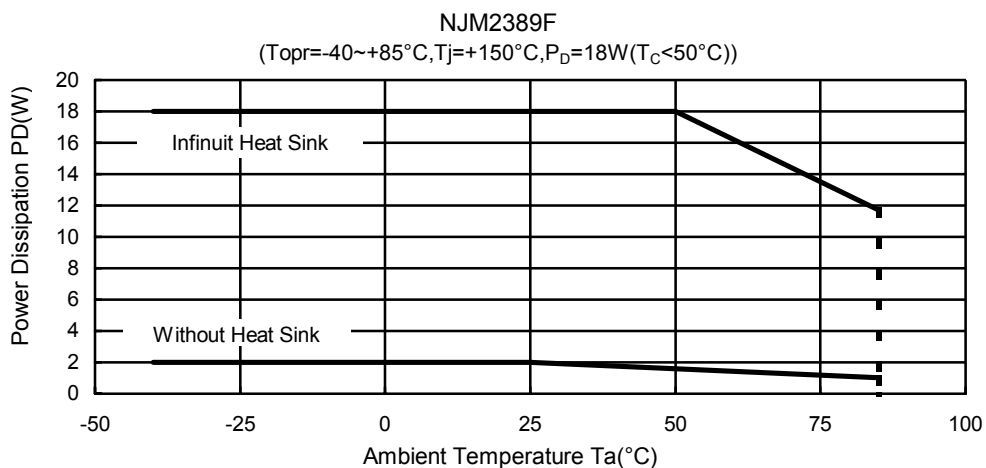

■ TEST CIRCUIT

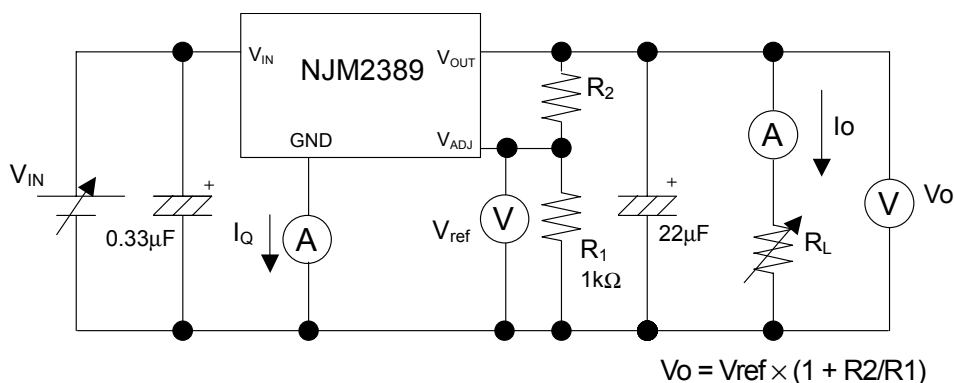

TYPICAL CHARACTERISTICS

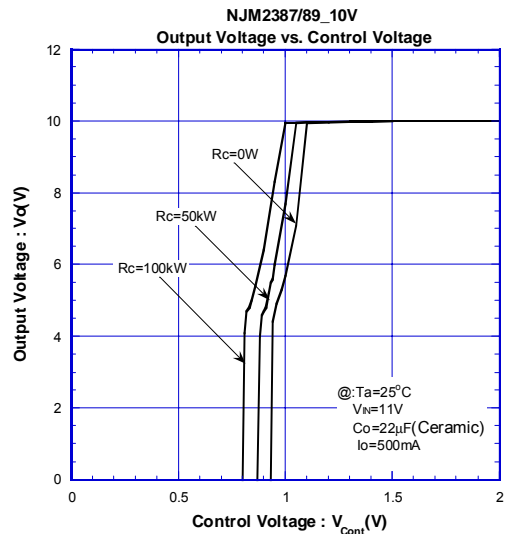
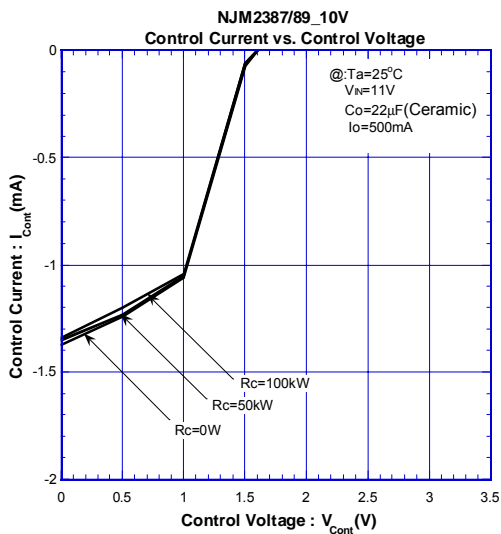
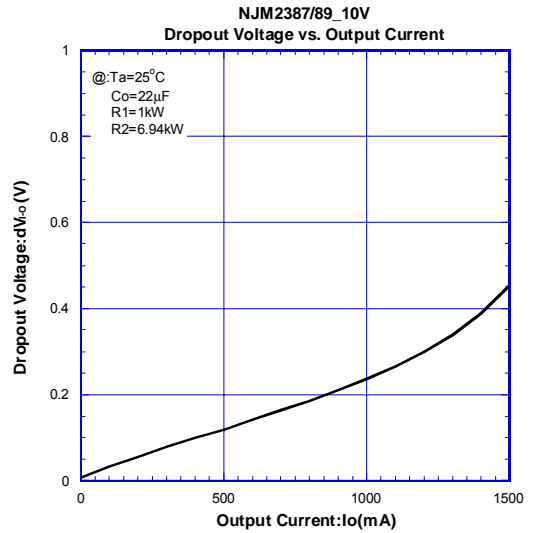
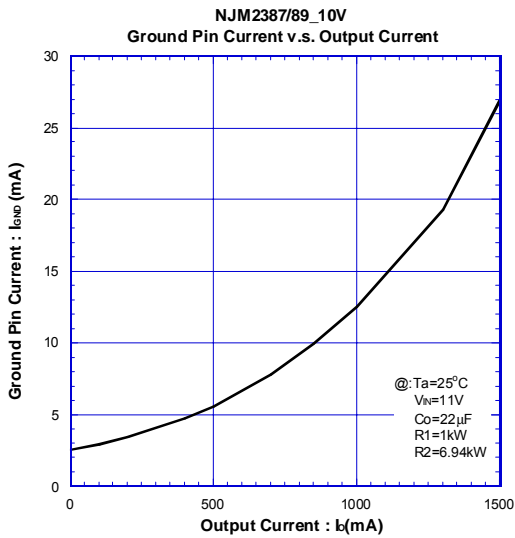
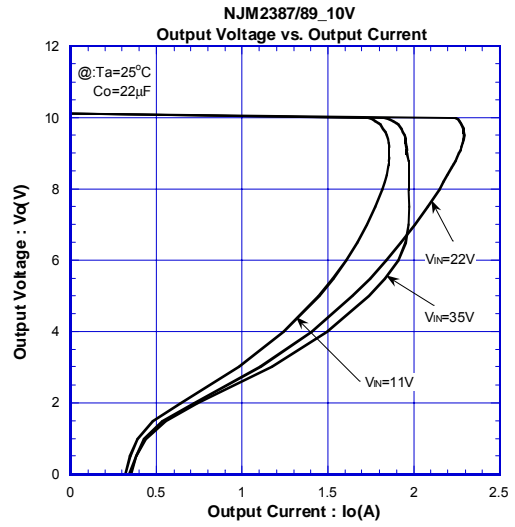
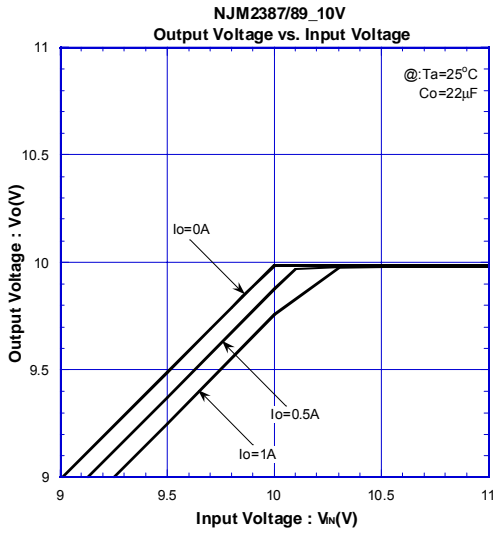

NJM2387/89

■ TYPICAL CHARACTERISTICS

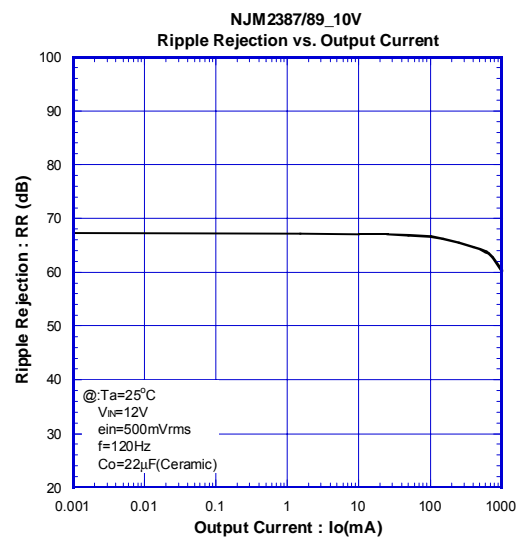
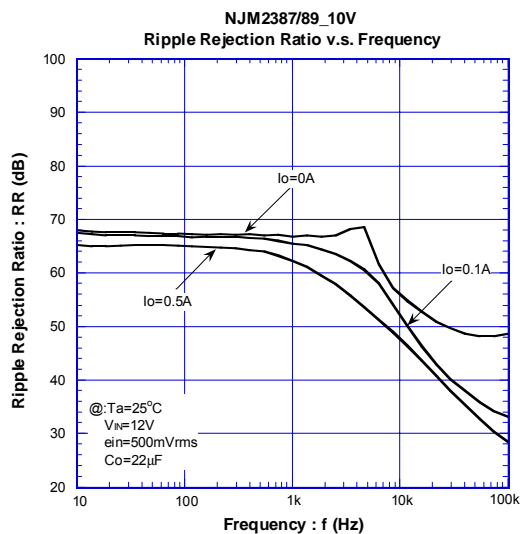
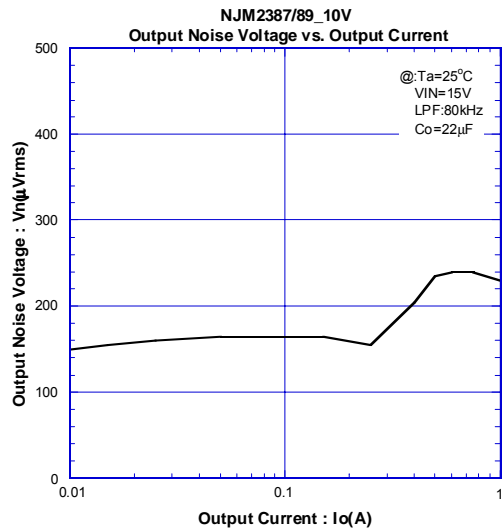
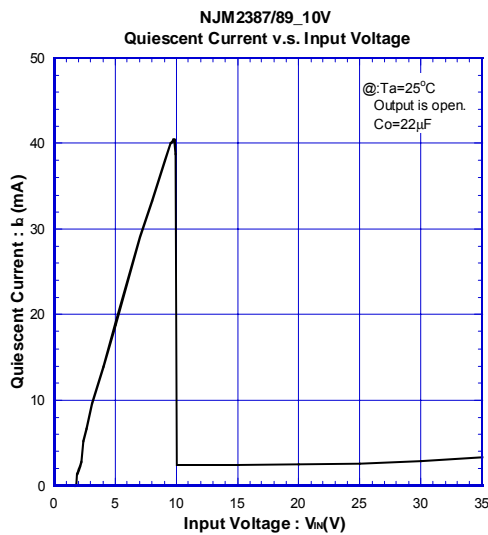
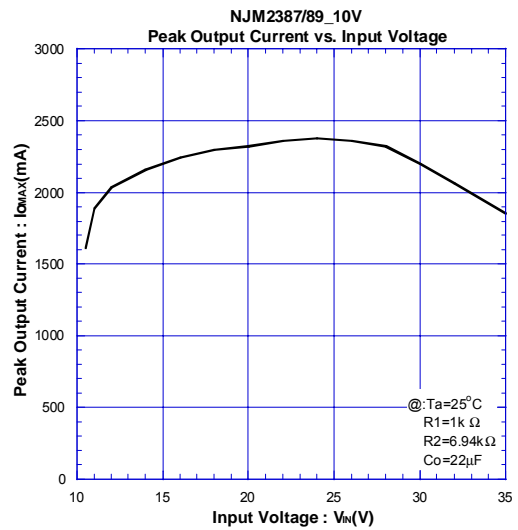
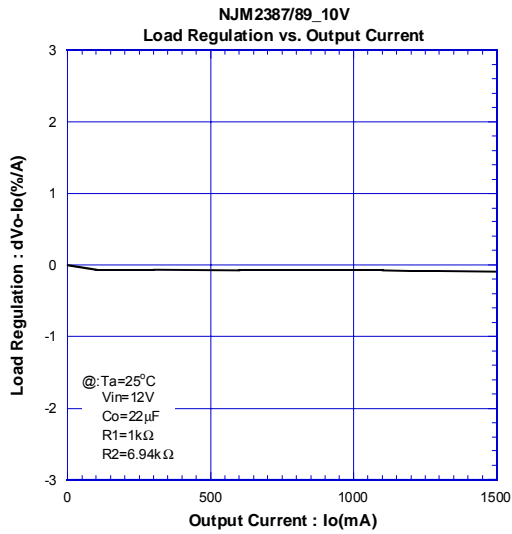

TYPICAL CHARACTERISTICS

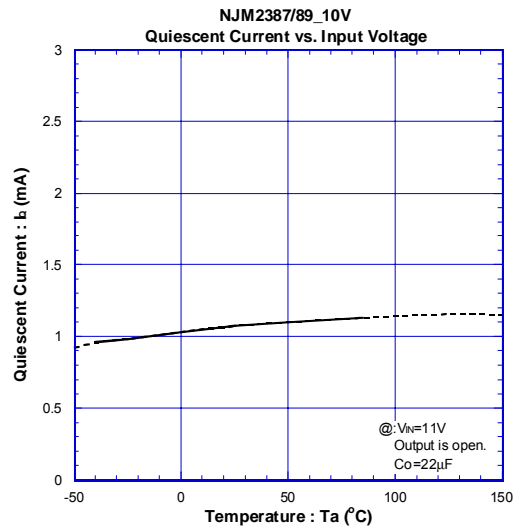
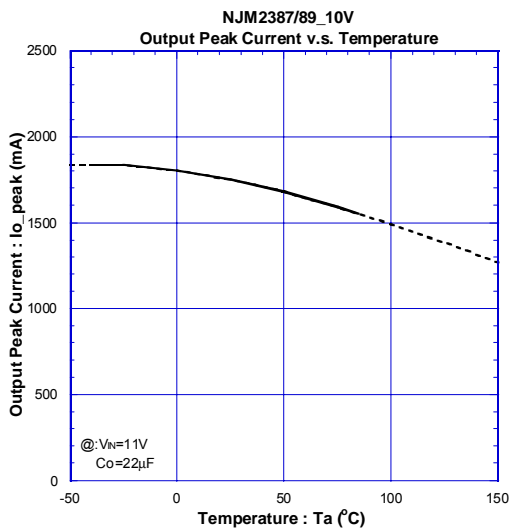
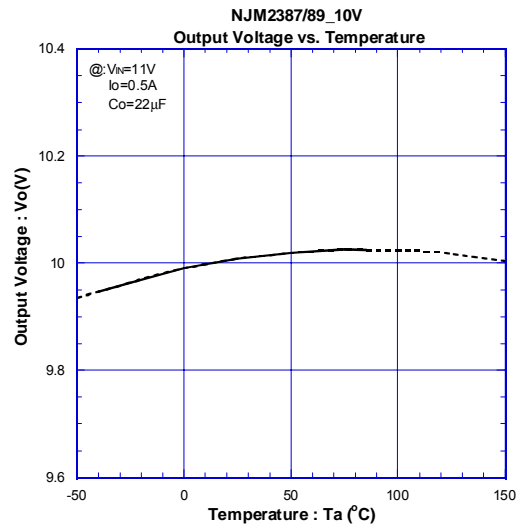
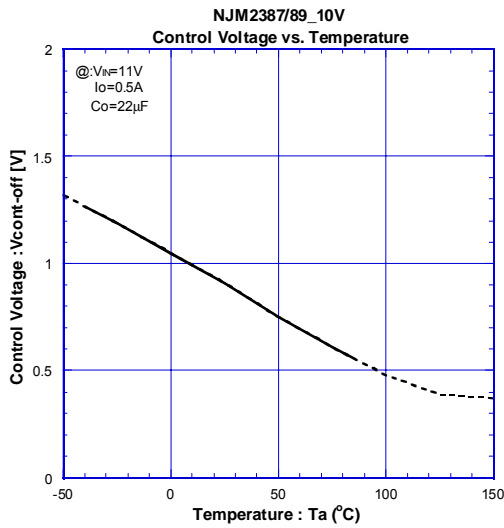
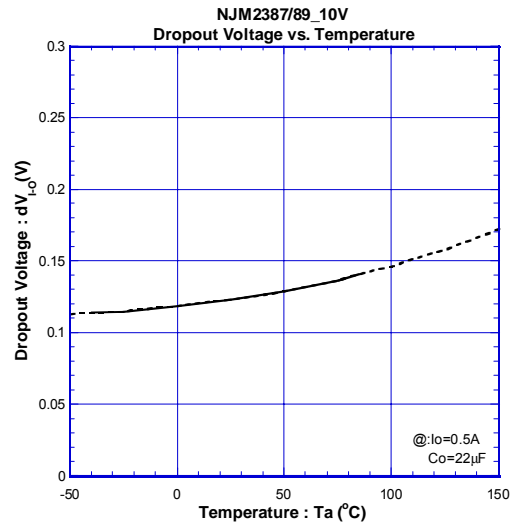
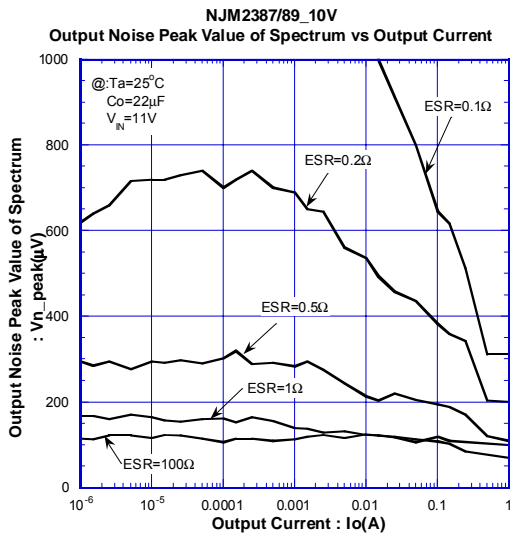

NJM2387/89

TYPICAL CHARACTERISTICS

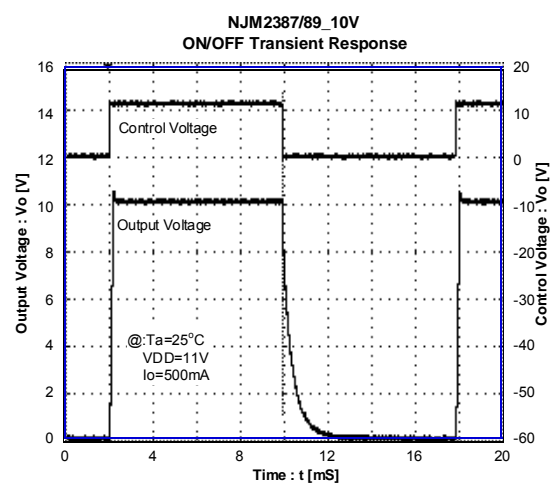
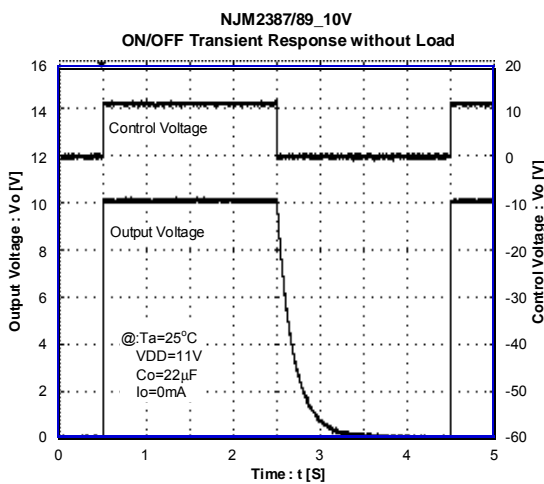
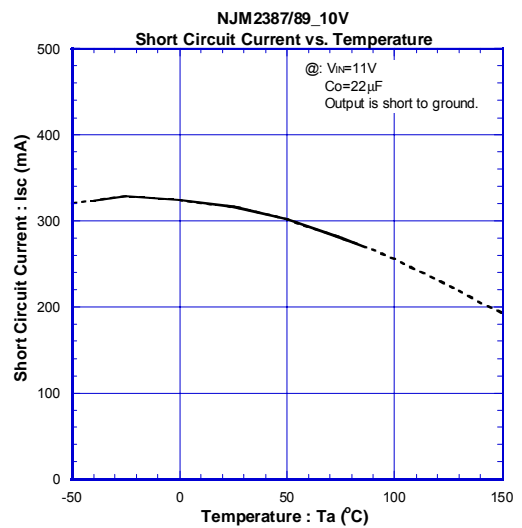
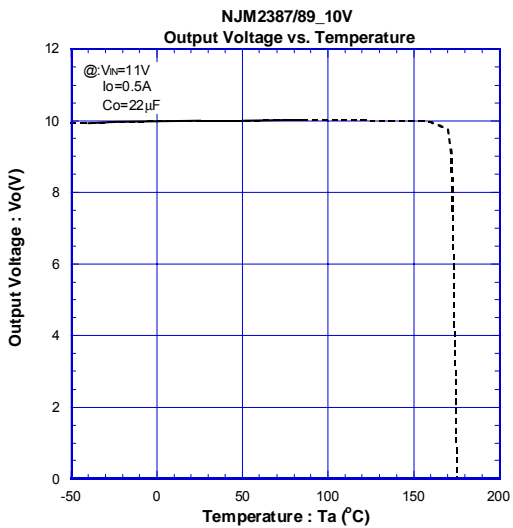
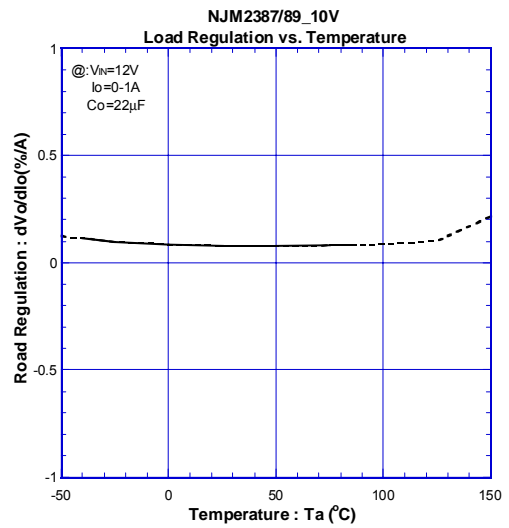
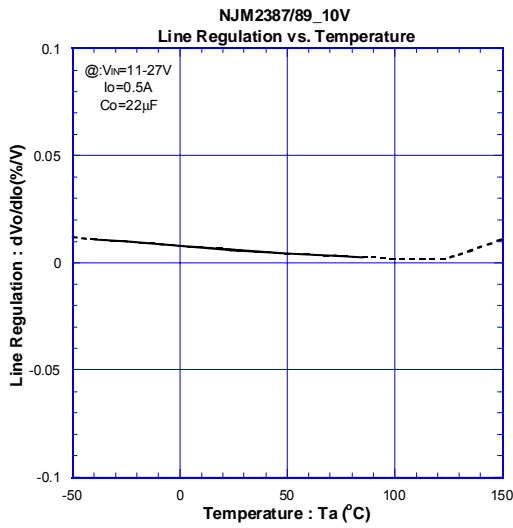

■ TYPICAL CHARACTERISTICS

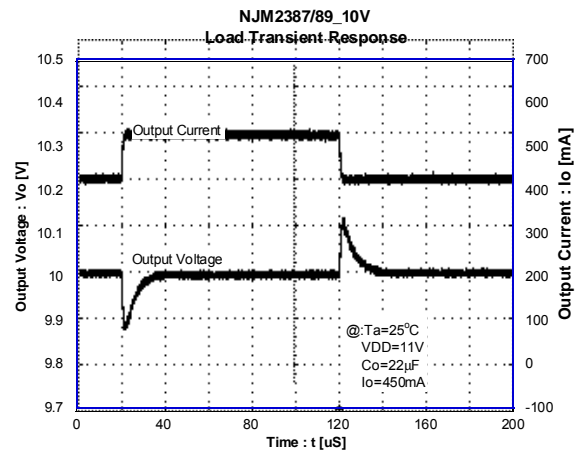
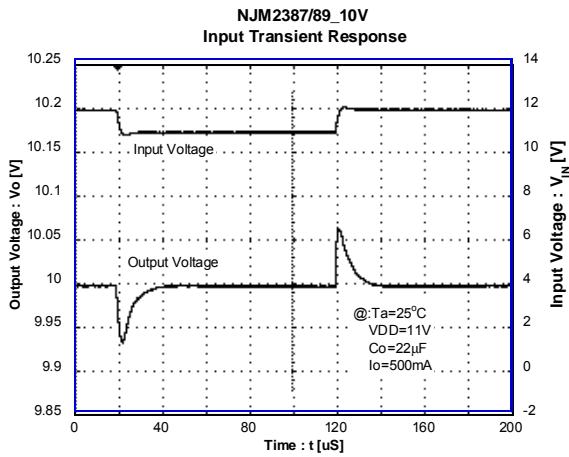

[CAUTION]

The specifications on this databook are only given for information, without any guarantee as regards either mistakes or omissions. The application circuits in this databook are described only to show representative usages of the product and not intended for the guarantee or permission of any right including the industrial rights.

Mouser Electronics

Authorized Distributor

Click to View Pricing, Inventory, Delivery & Lifecycle Information:

[NJR:](#)

[NJM2387DL2-TE1](#) [NJM2387DL3-TE1](#) [NJM2389F](#)