

THIS DRAWING IS UNPUBLISHED. RELEASED FOR PUBLICATION
 © COPYRIGHT BY TYCO ELECTRONICS CORPORATION. ALL RIGHTS RESERVED.

LOC	DIST	REVISIONS			
P	LTR	DESCRIPTION	DATE	DWN	APVD
—	—	A	REVISED PER ECO-09-014471	18JUN09	HMR CR

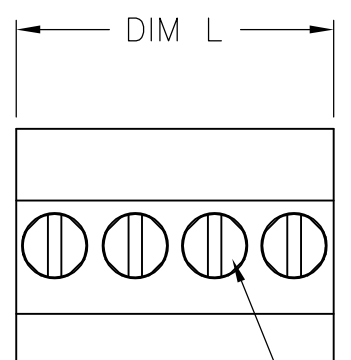

CLAMPING SCREW

MATERIALS AND FINISH:
 HOUSING: PA 6-6, UL94V-0, COLOR: GREEN.
 CLAMP: BRASS, NICKEL PLATED.
 CONTACT SPRING: PHOSPHOR BRONZE, TIN PLATED.
 CLAMPING SCREW: M2, BRASS, NICKEL PLATED.

ELECTRICAL:
 VOLTAGE RATING: 300V
 CURRENT RATING: 11A
 WIRE SIZE RANGE: 14-30 AWG

ENVIRONMENTAL:
 OPERATING TEMP RANGE: -40°C TO +110°C

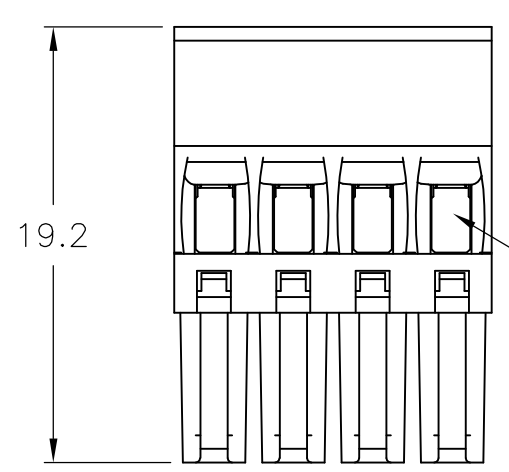

WIRE ENTRY

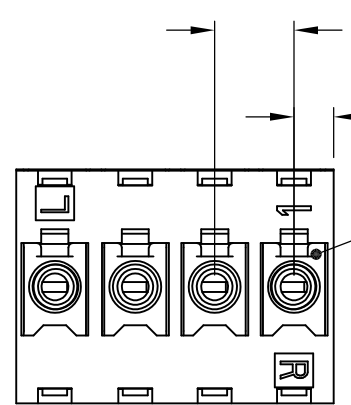
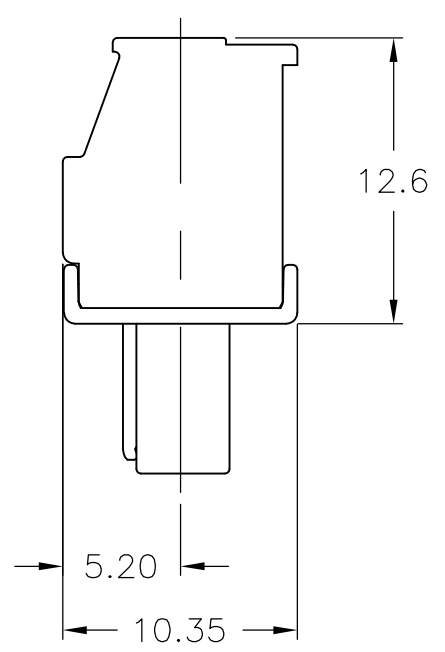

MATING FACE

56.0	16	1-1986370-6
52.5	15	1-1986370-5
49.0	14	1-1986370-4
45.5	13	1-1986370-3
42.0	12	1-1986370-2
38.5	11	1-1986370-1
35.0	10	1-1986370-0
31.5	9	1986370-9
28.0	8	1986370-8
24.5	7	1986370-7
21.0	6	1986370-6
17.5	5	1986370-5
14.0	4	1986370-4
10.5	3	1986370-3
7.0	2	1986370-2
DIM L	NO OF POS	PART NUMBER

THIS DRAWING IS A CONTROLLED DOCUMENT.		DWN S SCHLEGEL 17MAR2008	Tyco Electronics Corporation Harrisburg, PA 17105-3608	
DIMENSIONS: mm		CHK C RICHARD 3/17/08		
TOLERANCES UNLESS OTHERWISE SPECIFIED:		APVD C RICHARD 3/17/08	NAME	
0 PLC ± - 1 PLC ± 0.3 2 PLC ± 0.25 3 PLC ± - 4 PLC ± - ANGLES ± 2°		PRODUCT SPEC	TERMINAL BLOCK, PLUG, VERTICAL STACKING, RIGHT HAND, 3.50mm PITCH	
MATERIAL -		FINISH -	APPLICATION SPEC	RESTRICTED TO
		WEIGHT -	SIZE A3	CAGE CODE 00779
		CUSTOMER DRAWING	DRAWING NO G-1986370	REVISION A
		SCALE NTS	SHEET 1 OF 1	REV A

Mouser Electronics

Authorized Distributor

Click to View Pricing, Inventory, Delivery & Lifecycle Information:

[TE Connectivity:](#)

[1986370-7](#)