

COUNT	DESCRIPTION OF REVISIONS	BY	CHKD	DATE	COUNT	DESCRIPTION OF REVISIONS	BY	CHKD	DATE
△					△				
△					△				
△					△				

CODE No.	PARTS No.	NUMBER OF CONTACT	A	B	C	D	E
CL536-0301-8-21	DF13A-2P-1.25H(21)	2	1.25	3.15	4.15	7.15	5.65
CL536-0302-0-21	DF13A-3P-1.25H(21)	3	2.50	4.40	5.40	8.40	6.90
CL536-0303-3-21	DF13A-4P-1.25H(21)	4	3.75	5.65	6.65	9.65	8.15
CL536-0304-6-21	DF13A-5P-1.25H(21)	5	5.00	6.90	7.90	10.90	9.40
CL536-0305-9-21	DF13A-6P-1.25H(21)	6	6.25	8.15	9.15	12.15	10.65
CL536-0306-1-21	DF13A-7P-1.25H(21)	7	7.50	9.40	10.40	13.40	11.90
CL536-0307-4-21	DF13A-8P-1.25H(21)	8	8.75	10.65	11.65	14.65	13.15
CL536-0308-7-21	DF13A-9P-1.25H(21)	9	10.00	11.90	12.90	15.90	14.40
CL536-0309-0-21	DF13A-10P-1.25H(21)	10	11.25	13.15	14.15	17.15	15.65
CL536-0310-9-21	DF13A-11P-1.25H(21)	11	12.50	14.40	15.40	18.40	16.90
CL536-0311-1-21	DF13A-12P-1.25H(21)	12	13.75	15.65	16.65	19.65	18.15
CL536-0313-7-21	DF13A-14P-1.25H(21)	14	16.25	18.15	19.15	22.15	20.65
CL536-0314-0-21	DF13A-15P-1.25H(21)	15	17.50	19.40	20.40	23.40	21.90

NOTE 1: THERE SHALL BE STANDOFF MORE THAN FIVE CONTACTS.  
 2: WHEN THIS CONNECTOR HAS TWO OR THREE CONTACTS, THE LOCK SHALL BE SET AT THE CENTER OF HOUSING. IF MORE THAN FOUR, THE TWO LOCKS SHALL BE SET AS SHOWN ON THIS DRAWING.  
 3: FLATNESS OF LEAD WITH REINFORCED METAL FITTINGS SHALL BE WITHIN 0.1mm.  
 4: WHEN THIS CONNECTOR HAS MORE THAN SEVEN CONTACTS, JRS MARKING AND POLARIZATION MARKING SHIFT TO THE PLACE INDICATING DOTTED LINES.

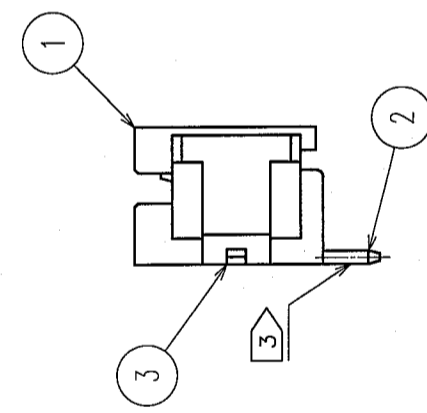

APPLICATION DRAWING

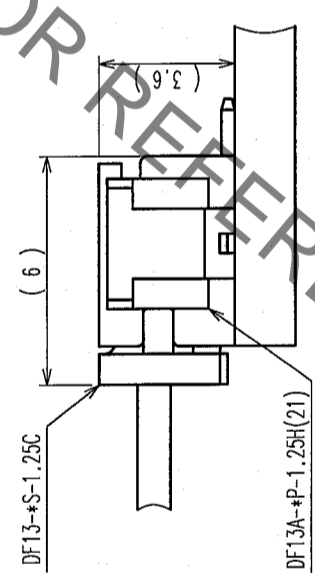

RECOMMENDED PATTERN

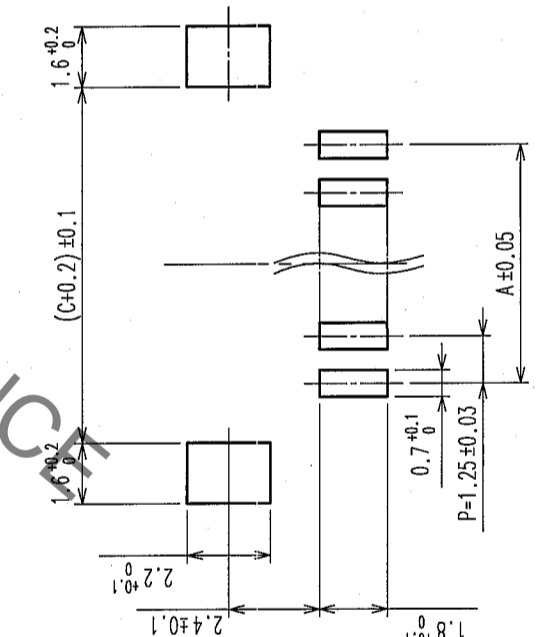
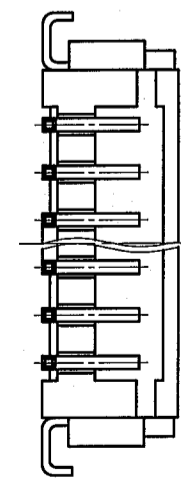
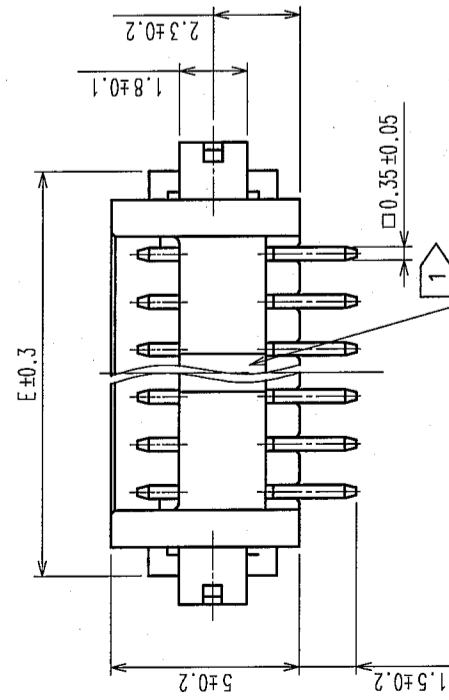
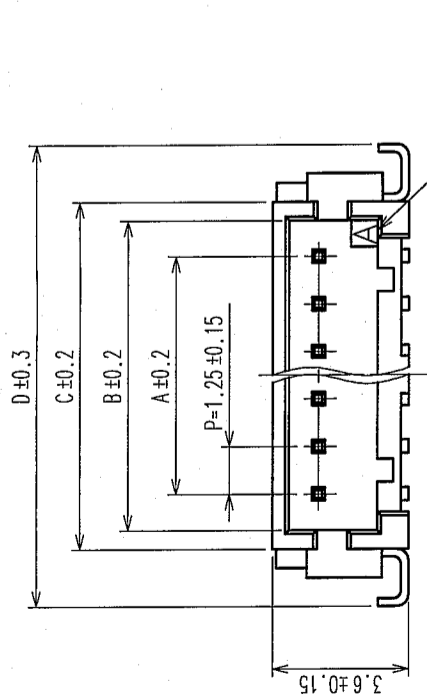

TO	

3	PHOSPHOR BRONZE	SURFACE : TIN PLATED 1μ mm min.	5	POLYESTER	COVER TAPE, CLEAR
2	BRASS	SURFACE : TIN PLATED 1μ mm min.	4	PS	EMBOSSED CARRIER TAPE, CLEAR
1	POLYAMIDE	BEIGE (UL94V-0)	No.	MATERIAL	FINISH, REMARKS
No.	MATERIAL	FINISH, REMARKS	No.	MATERIAL	FINISH, REMARKS

CODE NO. (OLD)		DRAWN		DESIGNED		CHECKED		APPROVED		RELEASED	
		A. Miura		T. Kumagawa		H. Umehara		J. Oka			
		'05.10.24		'05.10.27		'05.10.31		'05.10.31			
DRAWING NO.		PART NO.		CODE NO.		CL536-		DF13A-*P-1.25H(21)		1/2	
EDC3-162444-04		DF13A-*P-1.25H(21)		CL536-		DF13A-*P-1.25H(21)		CL536-		FORM NO. 229	
SCALE		UNITS		ITEM		HRS		HIROSE ELECTRIC CO., LTD		8	
5 : 1		ITTM		5		6		7		8	

2 In case of consideration for using Automotive equipment / device which demand high reliability, kindly contact our sales window correspondents.

COUNT	DESCRIPTION OF REVISIONS	BY	CHKD	DATE	DESCRIPTION OF REVISIONS	BY	CHKD	DATE
△								
△								
△								

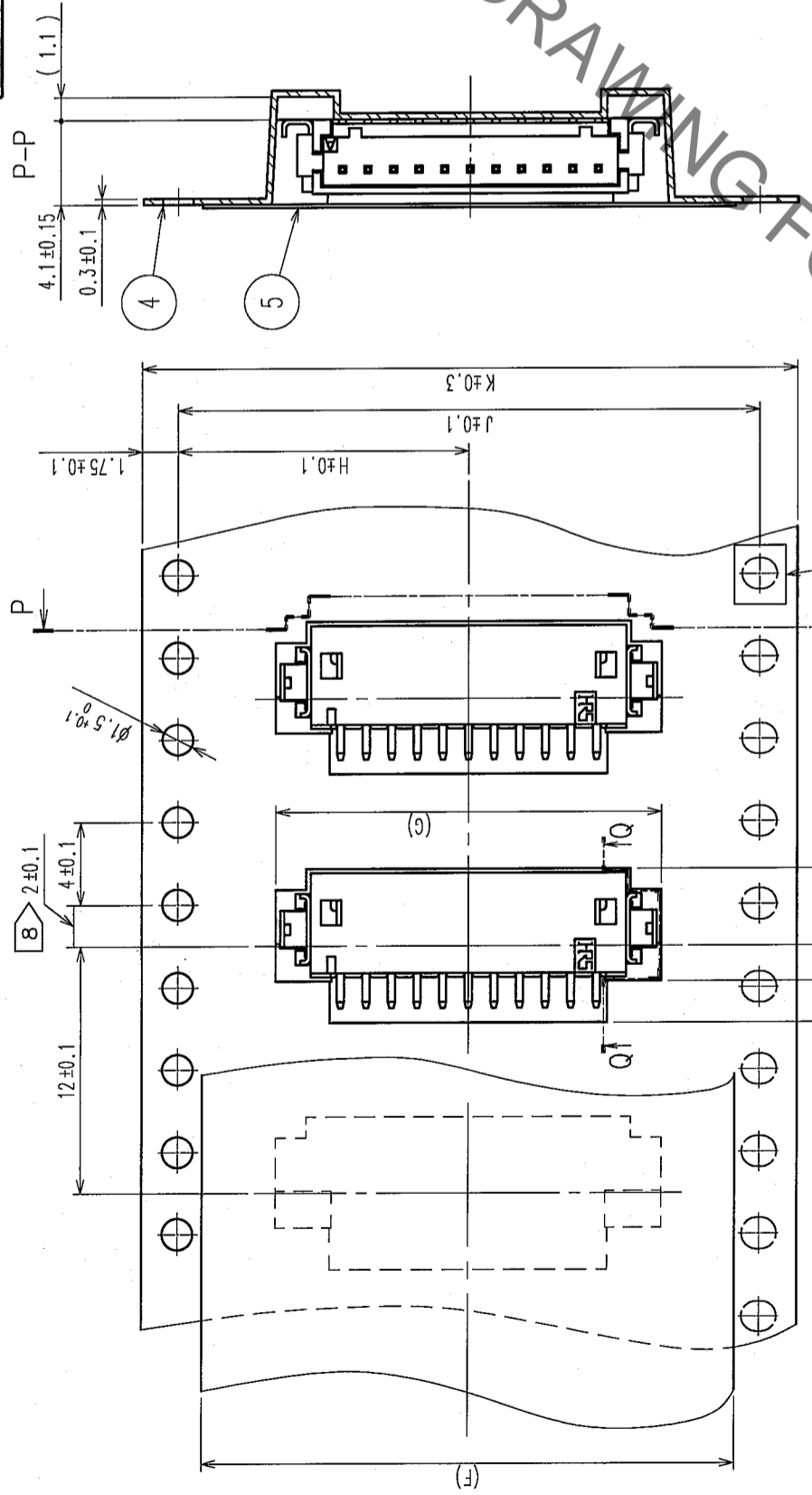

DIRECTION OF UNREELING

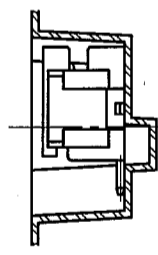

STYLE AND DIMENSION OF REEL

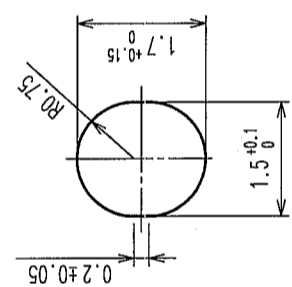
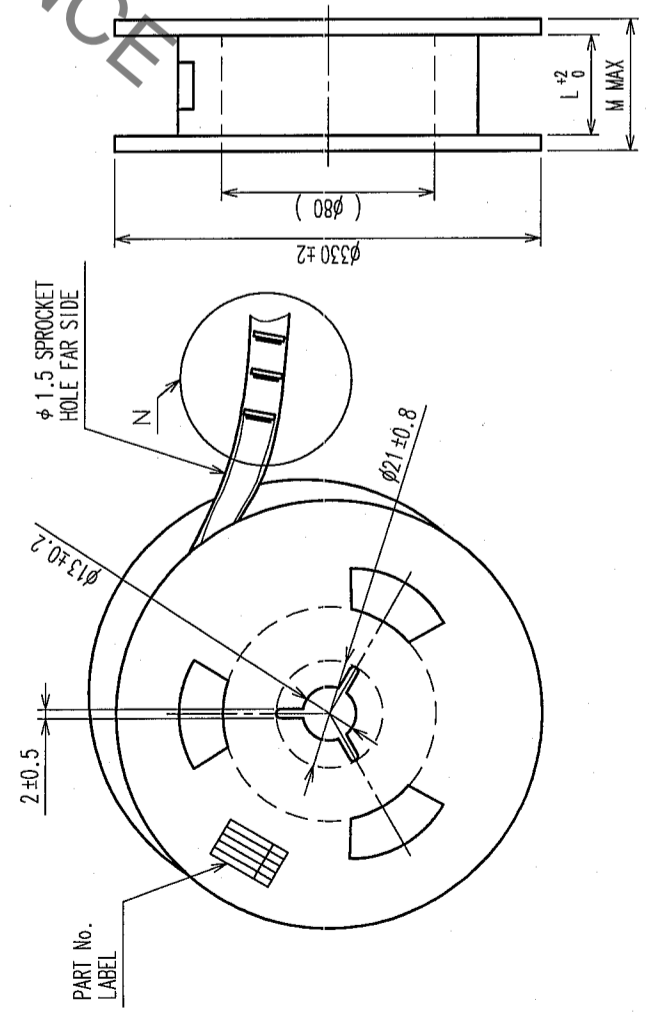

9 > DETAIL OF PART NO. LABEL

DATE OF MANUFACTURED	*** ** *
CODE NO.	*** ** *
PART NO.	DF13A-P-1.25H(21)
QUANTITY	1000 KO
SUPPLIER	HIROSE ELECTRIC CO., LTD.

- NOTE
- 5 : 1 REEL: 1000 CONNECTORS.
  - 6 : AT THE BEGINNING OF THE REEL, 30 COMPONENTS SHALL BE EMPTY.
  - 7 : AT THE END OF THE REEL, 20 COMPONENTS SHALL BE EMPTY.
  - 8 : WHEN THE TAPE WIDTH IS 32 OR 44mm, SPROCKET HOLES SHALL BE SET ON BOTH SIDES OF REEL AS SHOWN ON THIS DRAWING.
  - 9 : WHEN THE TAPE WIDTH IS 44mm OR OVER, THE TOLERANCE SHALL BE 2±0.15.
  - 10 : REEL FORCE BETWEEN EMBOSSED CARRIER TAPE AND COVER TAPE IS 0.1~0.7N.

CODE No.	PART No.	F	G	H	J	K	L	M
CL536-0301-8-21	DF13A- 2P-1.25H(21)	13.5	7.60	7.5	/	16	16.4	22.4
CL536-0302-0-21	DF13A- 3P-1.25H(21)	13.5	8.85	7.5	/	16	16.4	22.4
CL536-0303-3-21	DF13A- 4P-1.25H(21)	21.5	10.1	11.5	/	24	24.4	30.4
CL536-0304-6-21	DF13A- 5P-1.25H(21)	21.5	11.35	11.5	/	24	24.4	30.4
CL536-0305-9-21	DF13A- 6P-1.25H(21)	21.5	12.6	11.5	/	24	24.4	30.4
CL536-0306-1-21	DF13A- 7P-1.25H(21)	21.5	13.85	11.5	/	24	24.4	30.4
CL536-0307-4-21	DF13A- 8P-1.25H(21)	21.5	15.1	11.5	/	24	24.4	30.4
CL536-0308-7-21	DF13A- 9P-1.25H(21)	21.5	16.35	11.5	/	24	24.4	30.4
CL536-0309-0-21	DF13A-10P-1.25H(21)	21.5	17.6	11.5	/	24	24.4	30.4
CL536-0310-9-21	DF13A-11P-1.25H(21)	26.0	18.85	14.2	28.4	32	32.4	38.4
CL536-0311-1-21	DF13A-12P-1.25H(21)	26.0	20.1	14.2	28.4	32	32.4	38.4
CL536-0313-7-21	DF13A-14P-1.25H(21)	26.0	22.6	14.2	28.4	32	32.4	38.4
CL536-0314-0-21	DF13A-15P-1.25H(21)	37.0	23.85	20.2	40.4	44	44.4	50.4

CODE NO. (OLD)	CL	DESIGNED	T. Romyama	CHECKED	H. Tanaka	APPROVED	J. Oka	RELEASED
SCALE	FREE	DRAWN	A. Miura	DESIGNED	'05.10.24	CHECKED	'05.10.27	RELEASED
UNITS	mm	DRAWING NO.	EDC3-162444-04	DESIGNED	'05.10.24	CHECKED	'05.10.27	RELEASED
		PART NO.	DF13A-P-1.25H(21)	DESIGNED	'05.10.24	CHECKED	'05.10.27	RELEASED
		CODE NO.	CL536-	DESIGNED	'05.10.24	CHECKED	'05.10.27	RELEASED

TO	