

Description

Sensitive Triacs are intended in general purpose applications where high surge current capability is required. These Triacs feature a gate current capability sensitivities of 5 mA or 10 mA depending on the quadrant.

Table 1. Device summary

Symbol	Value	Unit
$I_{T(rms)}$	4	A
V_{DRM}, V_{RRM}	600	V
V_{DSM}, V_{RSM}	700	V
I_{GT}	5 / 10 ⁽¹⁾	mA

1. Quadrant I,II,III = 5 mA, quadrant IV = 10 mA.

Features

- MCU direct gate drive
- 4 quadrants Triac
- ECOPACK[®]2 compliant component

Applications

- Motor control circuits
- Small home appliances
- Fan speed controller
- Pump and valve drive
- Mahjong machines
- Lighting dimmers

1 Characteristics

Table 2. Absolute maximum ratings ($T_j = 25\text{ °C}$ unless otherwise stated)

Symbol	Parameter			Value	Unit	
$I_{T(rms)}$	On-state rms current (full sine wave)	I _{PAK} , DPAK	$T_c = 110\text{ °C}$	4	A	
I_{TSM}	Non repetitive surge peak on-state current (full cycle, T_j initial = 25 °C)			$t_p = 20\text{ ms}$	35	A
				$t_p = 16.7\text{ ms}$	38	
I^2t	I^2t value for fusing		$t_p = 10\text{ ms}$	6	A ² s	
di/dt	Critical rate of rise of on-state current $I_G = 2 \times I_{GT}$, $t_r \leq 100\text{ ns}$		$F = 100\text{ Hz}$	50	A/ μ s	
I_{GM}	Peak gate current	$t_p = 20\text{ }\mu$ s	$T_j = 125\text{ °C}$	4	A	
$P_{G(AV)}$	Average gate power dissipation		$T_j = 125\text{ °C}$	0.5	W	
T_{stg} T_j	Storage junction temperature range Operating junction temperature range			- 40 to + 150 - 40 to + 125	°C	
V_{DSM} , V_{RSM}	Non repetitive surge peak off-state voltage		$t_p = 10\text{ ms}$	700	V	

Table 3. Electrical characteristics ($T_j = 25\text{ °C}$, unless otherwise stated)

Symbol	Test conditions	Quadrant		Value	Unit
				T405Q	
$I_{GT}^{(1)}$	$V_D = 12\text{ V}$, $R_L = 30\text{ }\Omega$	I - II - III IV	Max.	5 10	mA
V_{GT}	$V_D = 12\text{ V}$, $R_L = 30\text{ }\Omega$	All	Max.	1.3	V
V_{GD}	$V_D = V_{DRM}$, $R_L = 3.3\text{ k}\Omega$, $T_j = 125\text{ °C}$	All	Min.	0.2	V
$I_H^{(2)}$	$I_T = 100\text{ mA}$		Max.	10	mA
I_L	$I_G = 1.2 I_{GT}$	I - III - IV	Max.	10	mA
		II	Max.	15	
$dV/dt^{(2)}$	$V_D = 67\% V_{DRM}$, gate open	$T_j = 125\text{ °C}$	Min.	10	V/ μ s
$(di/dt)_c^{(2)}$	$(dV/dt)_c = 2\text{ V}/\mu$ s	$T_j = 125\text{ °C}$	Min.	1.8	A/ms

1. Minimum I_{GT} is guaranteed at 5% of I_{GT} max.

2. For both polarities of A2 referenced to A1

Table 4. Static characteristics

Symbol	Test conditions			Value	Unit
$V_{TM}^{(1)}$	$I_{TM} = 5 \text{ A}$, $t_p = 380 \mu\text{s}$	$T_j = 25 \text{ }^\circ\text{C}$	Max.	1.5	V
$V_{t0}^{(1)}$	Threshold voltage	$T_j = 125 \text{ }^\circ\text{C}$	Max.	0.85	V
$R_d^{(1)}$	Dynamic resistance	$T_j = 125 \text{ }^\circ\text{C}$	Max.	100	m Ω
I_{DRM} I_{RRM}	$V_{DRM} = V_{RRM}$	$T_j = 25 \text{ }^\circ\text{C}$	Max.	5	μA
		$T_j = 125 \text{ }^\circ\text{C}$		1	mA

1. For both polarities of A2 referenced to A1

Table 5. Thermal resistance

Symbol	Parameter		Value	Unit	
$R_{th(j-c)}$	Junction to case (AC)		3	$^\circ\text{C/W}$	
$R_{th(j-a)}$	Junction to ambient	$S^{(1)} = 0.5 \text{ cm}^2$	DPAK	70	$^\circ\text{C/W}$
			IPAK	100	$^\circ\text{C/W}$

1. S = Copper surface under tab.

Figure 1. Maximum power dissipation versus RMS on-state current

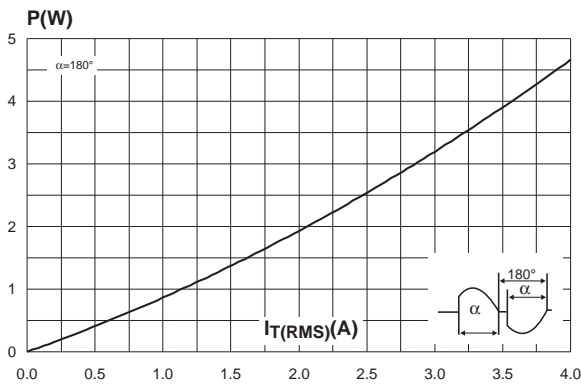

Figure 2. RMS on-state current versus case temperature

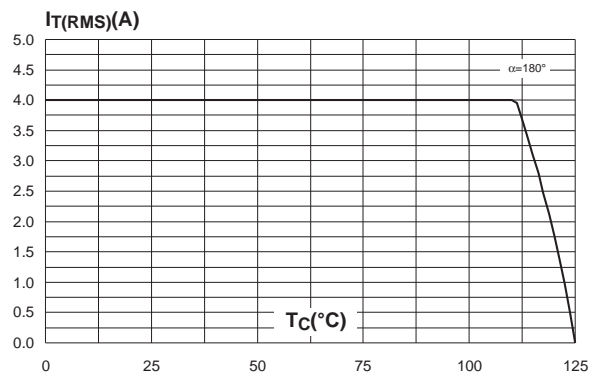

Figure 3. Relative variation of thermal impedance versus pulse duration

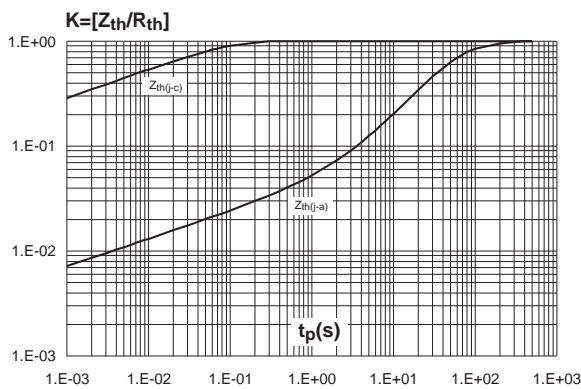

Figure 4. On-state characteristics (maximum values)

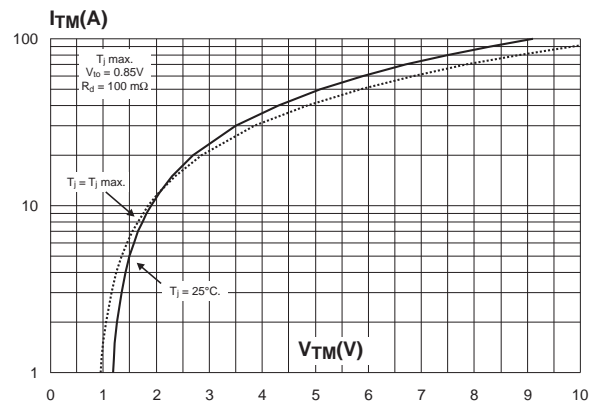

Figure 5. Surge peak on-state current versus number of cycles

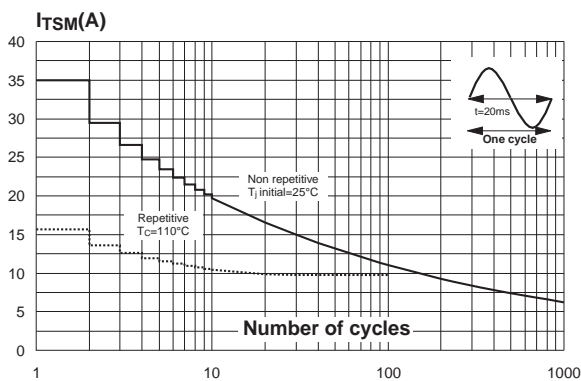

Figure 6. Non-repetitive surge peak on-state current for a sinusoidal pulse with width tp < 10 ms

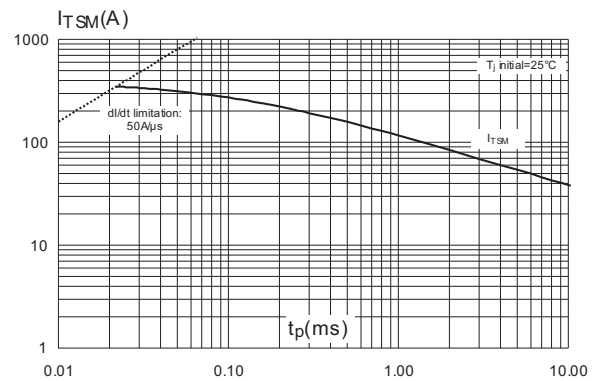

Figure 7. Relative variation of gate trigger current, holding current and latching current versus junction temperature (typical values)

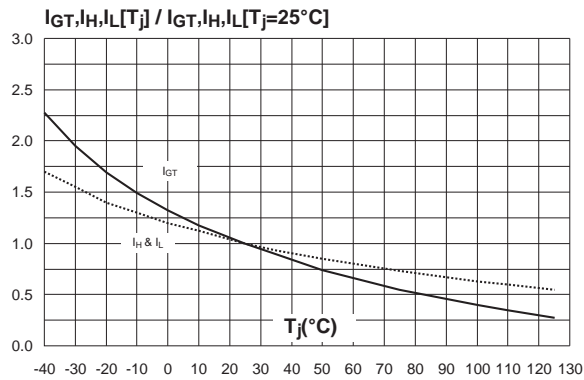

Figure 8. Relative variation of critical rate of decrease of main current versus (dV/dt)_c (typical values)

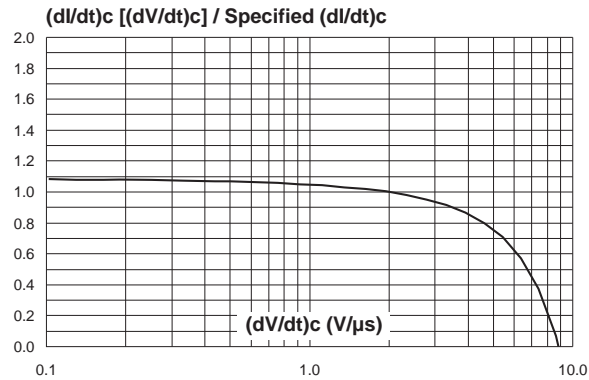

Figure 9. Relative variation of critical rate of decrease of main current versus junction temperature

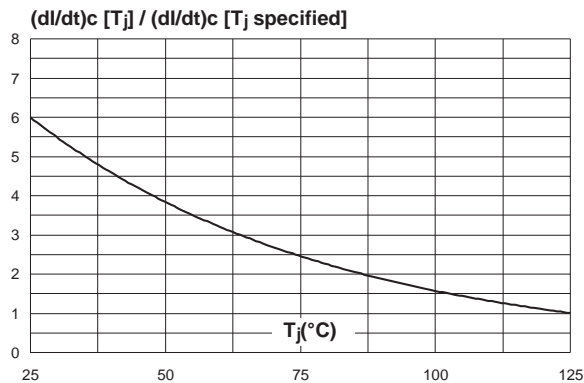

Figure 10. Relative variation of static dV/dt immunity versus junction temperature

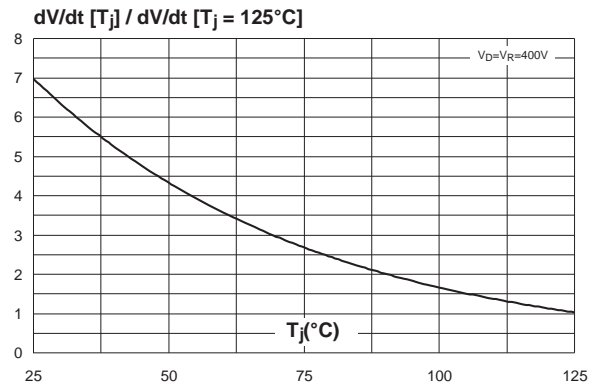
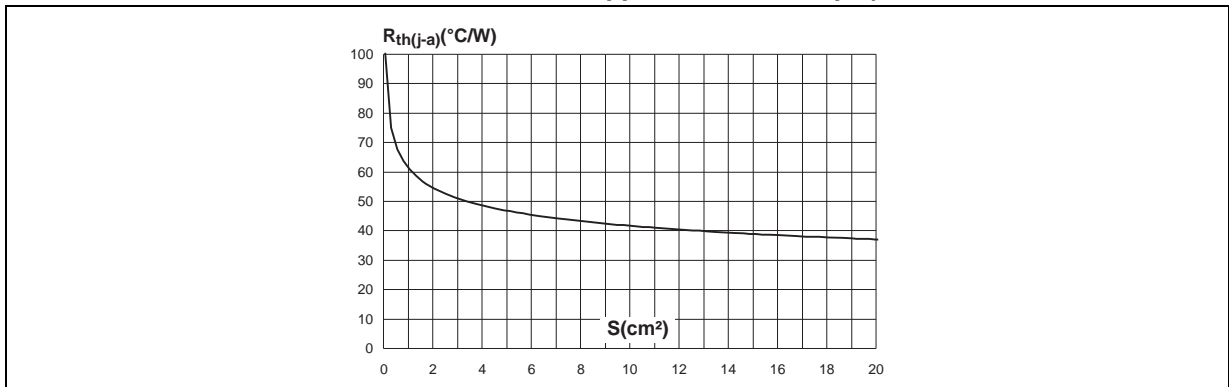

Figure 11. DPAK thermal resistance junction to ambient versus copper surface under tab (printed circuit board FR4, copper thickness: 35 μm)



2 Package information

- Epoxy meets UL94, V0
- Lead-free package
- Recommended torque: 0.4 to 0.6 N·m

In order to meet environmental requirements, ST offers these devices in different grades of ECOPACK® packages, depending on their level of environmental compliance. ECOPACK® specifications, grade definitions and product status are available at: www.st.com. ECOPACK® is an ST trademark.

2.1 DPAK package information

Figure 12. DPAK package outline

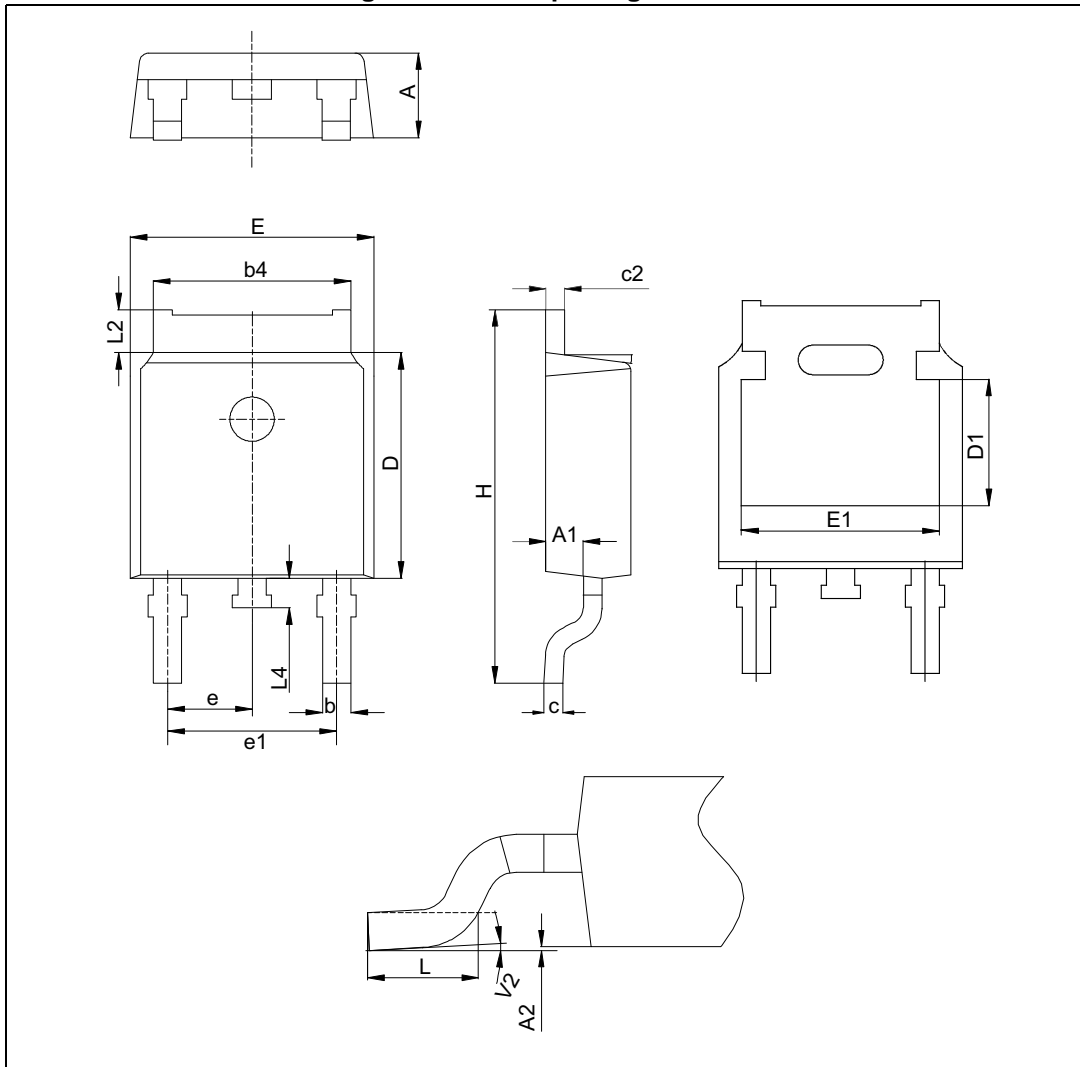

Note: This package drawing may slightly differ from the physical package. However, all the specified dimensions are guaranteed.

Table 6. DPAK package mechanical data

Ref.	Dimensions					
	Millimeters			Inches ⁽¹⁾		
	Min.	Typ.	Max.	Min.	Typ.	Max.
A	2.18		2.40	0.0858		0.0945
A1	0.90		1.10	0.0354		0.0433
A2	0.03		0.23	0.0012		0.0091
b	0.64		0.90	0.0252		0.0354
b4	4.95		5.46	0.1949		0.2150
c	0.46		0.61	0.0181		0.0240
c2	0.46		0.60	0.0181		0.0236
D	5.97		6.22	0.2350		0.2449
D1	4.95		5.60	0.1949		0.2204
E	6.35		6.73	0.2500		0.2650
E1	4.32		5.50	0.1701		0.2165
e		2.286			0.0900	
e1	4.40		4.70	0.1732		0.1850
H	9.35		10.40	0.3681		0.4094
L	1.00		1.78	0.0394		0.0701
L2		1.27			0.0500	
L4	0.60		1.02	0.0236		0.0402
V2	-8°		8°	-8°		8°

1. Inch dimensions are only for reference

Figure 13. Footprint (dimensions in mm, drawing not in scale)

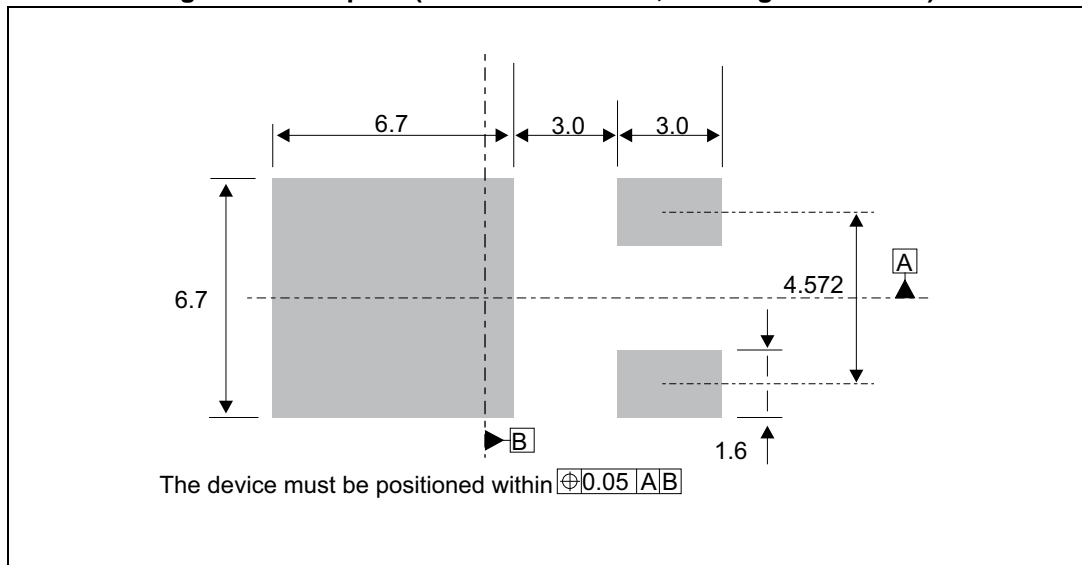

2.2 IPAK package information

Figure 14. IPAK package outline

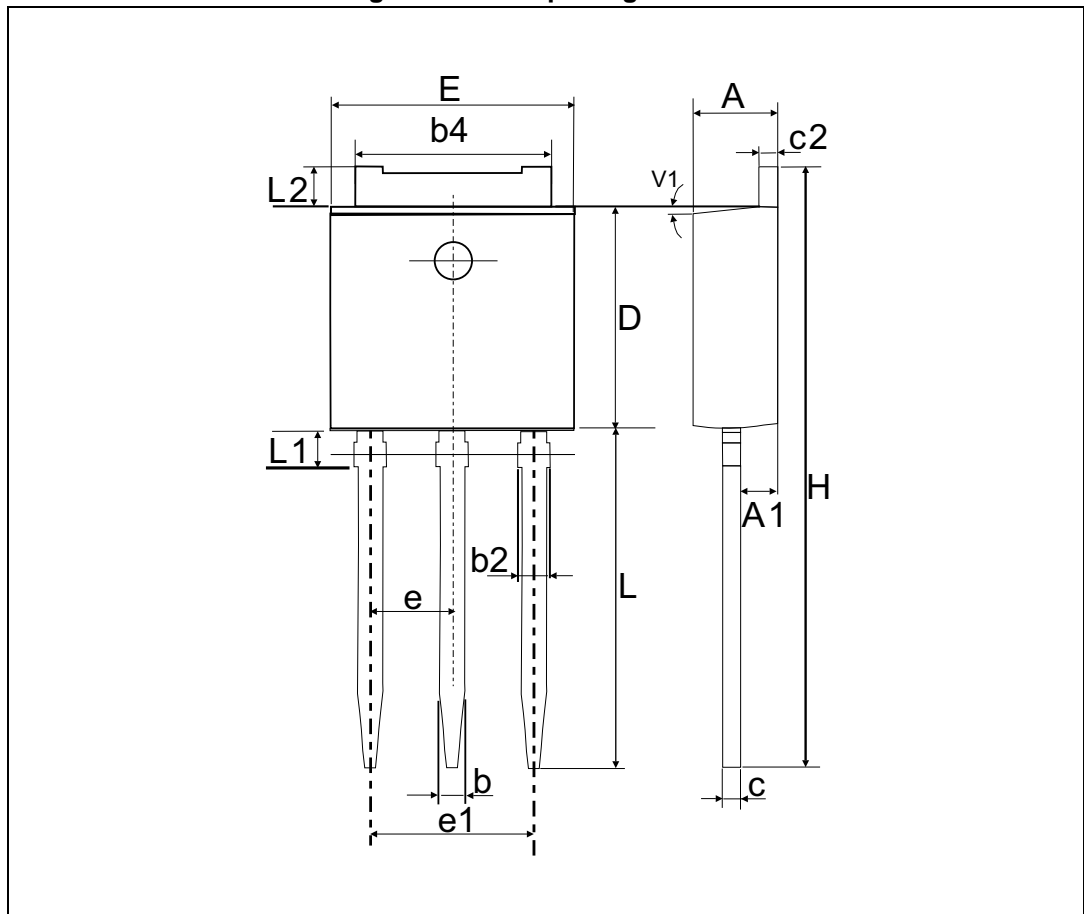

Note: This package drawing may slightly differ from the physical package. However, all the specified dimensions are guaranteed.

Table 7. IPAK package mechanical data

Ref.	Dimensions					
	Millimeters			Inches ⁽¹⁾		
	Min.	Typ.	Max.	Min.	Typ.	Max.
A	2.20		2.40	0.0866		0.0945
A1	0.90		1.10	0.0354		0.0433
b	0.64		0.90	0.0252		0.0354
b2			0.95			0.0374
b4	5.20		5.43	0.2047		0.2138
c	0.45		0.60	0.0177		0.0236
c2	0.46		0.60	0.0181		0.0236
D	6		6.20	0.2362		0.2441
E	6.40		6.65	0.2520		0.2618
e		2.28			0.0898	
e1	4.40		4.60	0.1732		0.1811
H		16.10			0.6339	
L	9		9.60	0.3543		0.3780
L1	0.8		1.20	0.0315		0.0472
L2		0.80	1.25		0.0315	0.0492
V1		10°			10°	

1. Inch dimensions are only for reference

3 Ordering information

Figure 15. Order information scheme

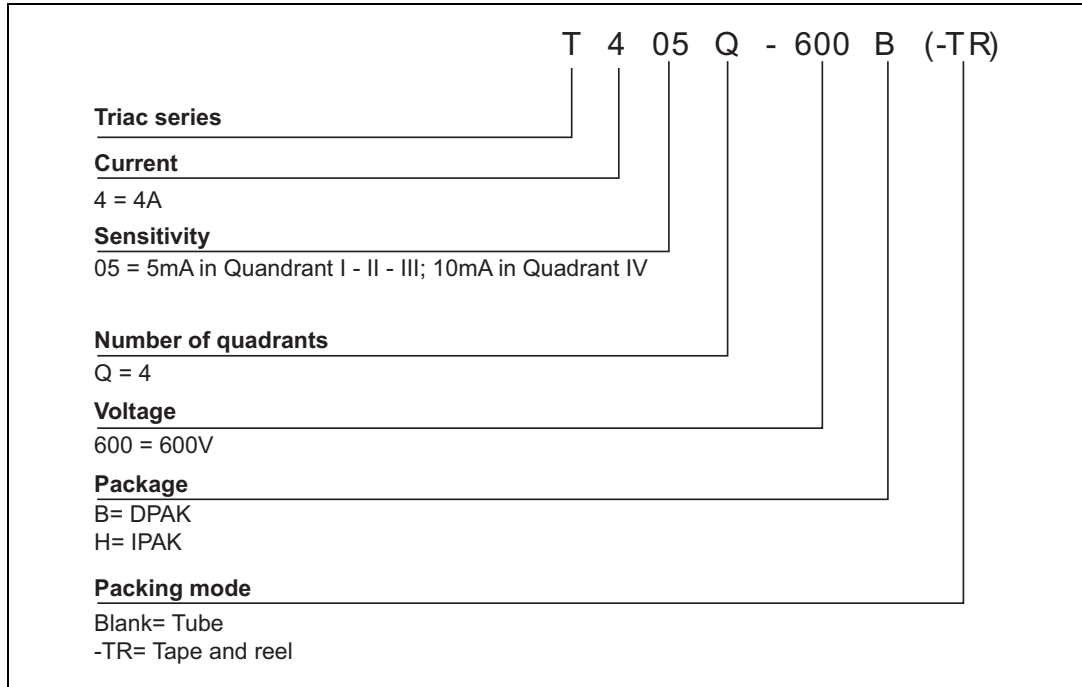

Table 8. Product selector

Part Number	Voltage	Sensitivity	Type	Package
T405Q-600B-TR	600 V	5 / 10 mA	Sensitive	DPAK
T405Q-600H	600 V	5 / 10 mA	Sensitive	IPAK

Table 9. Ordering information

Order code	Marking	Package	Weight	Base qty	Delivery mode
T405Q-600B-TR	T405Q 600	DPAK	0.3 g	2500	Tape and reel
T405Q-600H	T405Q 600	IPAK	0.4 g	75	Tube

4 Revision history

Table 10. Document revision history

Date	Revision	Changes
July-2002	1	First issue.
29-May-2014	2	Updated DPAK and IPAK package information and reformatted to current standard.
25-Sep-2015	3	Updated Features in cover page. Updated Table 3 and Section 2: Package information.
11-Feb-2016	4	Updated DPAK package information and reformatted to current standard. Added V_{DSM} parameter.

IMPORTANT NOTICE – PLEASE READ CAREFULLY

STMicroelectronics NV and its subsidiaries ("ST") reserve the right to make changes, corrections, enhancements, modifications, and improvements to ST products and/or to this document at any time without notice. Purchasers should obtain the latest relevant information on ST products before placing orders. ST products are sold pursuant to ST's terms and conditions of sale in place at the time of order acknowledgement.

Purchasers are solely responsible for the choice, selection, and use of ST products and ST assumes no liability for application assistance or the design of Purchasers' products.

No license, express or implied, to any intellectual property right is granted by ST herein.

Resale of ST products with provisions different from the information set forth herein shall void any warranty granted by ST for such product.

ST and the ST logo are trademarks of ST. All other product or service names are the property of their respective owners.

Information in this document supersedes and replaces information previously supplied in any prior versions of this document.

© 2016 STMicroelectronics – All rights reserved

Mouser Electronics

Authorized Distributor

Click to View Pricing, Inventory, Delivery & Lifecycle Information:

[STMicroelectronics:](#)

[T405Q-600H](#) [T405Q-600B-TR](#)