



Is Now Part of



ON Semiconductor®

To learn more about ON Semiconductor, please visit our website at
www.onsemi.com

Please note: As part of the Fairchild Semiconductor integration, some of the Fairchild orderable part numbers will need to change in order to meet ON Semiconductor's system requirements. Since the ON Semiconductor product management systems do not have the ability to manage part nomenclature that utilizes an underscore (_), the underscore (_) in the Fairchild part numbers will be changed to a dash (-). This document may contain device numbers with an underscore (_). Please check the ON Semiconductor website to verify the updated device numbers. The most current and up-to-date ordering information can be found at www.onsemi.com. Please email any questions regarding the system integration to Fairchild_questions@onsemi.com.

ON Semiconductor and the ON Semiconductor logo are trademarks of Semiconductor Components Industries, LLC dba ON Semiconductor or its subsidiaries in the United States and/or other countries. ON Semiconductor owns the rights to a number of patents, trademarks, copyrights, trade secrets, and other intellectual property. A listing of ON Semiconductor's product/patent coverage may be accessed at www.onsemi.com/site/pdf/Patent-Marking.pdf. ON Semiconductor reserves the right to make changes without further notice to any products herein. ON Semiconductor makes no warranty, representation or guarantee regarding the suitability of its products for any particular purpose, nor does ON Semiconductor assume any liability arising out of the application or use of any product or circuit, and specifically disclaims any and all liability, including without limitation special, consequential or incidental damages. Buyer is responsible for its products and applications using ON Semiconductor products, including compliance with all laws, regulations and safety requirements or standards, regardless of any support or applications information provided by ON Semiconductor. "Typical" parameters which may be provided in ON Semiconductor data sheets and/or specifications can and do vary in different applications and actual performance may vary over time. All operating parameters, including "Typicals" must be validated for each customer application by customer's technical experts. ON Semiconductor does not convey any license under its patent rights nor the rights of others. ON Semiconductor products are not designed, intended, or authorized for use as a critical component in life support systems or any FDA Class 3 medical devices or medical devices with a same or similar classification in a foreign jurisdiction or any devices intended for implantation in the human body. Should Buyer purchase or use ON Semiconductor products for any such unintended or unauthorized application, Buyer shall indemnify and hold ON Semiconductor and its officers, employees, subsidiaries, affiliates, and distributors harmless against all claims, costs, damages, and expenses, and reasonable attorney fees arising out of, directly or indirectly, any claim of personal injury or death associated with such unintended or unauthorized use, even if such claim alleges that ON Semiconductor was negligent regarding the design or manufacture of the part. ON Semiconductor is an Equal Opportunity/Affirmative Action Employer. This literature is subject to all applicable copyright laws and is not for resale in any manner.

FNA41560 / FNA41560B2

Motion SPM® 45 Series

Features

- UL Certified No. E209204 (UL1557)
- 600 V - 15 A 3-Phase IGBT Inverter with Integral Gate Drivers and Protection
- Low Thermal Resistance Using Ceramic Substrate
- Low-Loss, Short-Circuit Rated IGBTs
- Built-In Bootstrap Diodes and Dedicated Vs Pins Simplify PCB Layout
- Built-In NTC Thermistor for Temperature Monitoring
- Separate Open-Emitter Pins from Low-Side IGBTs for Three-Phase Current Sensing
- Single-Grounded Power Supply
- Optimized for 5 kHz Switching Frequency
- Isolation Rating: 2000 V_{rms} / min.

Applications

- Motion Control - Home Appliance / Industrial Motor

Related Resources

- [AN-9070 - Motion SPM® 45 Series Users Guide](#)
- [AN-9071 - Motion SPM® 45 Series Thermal Performance Information](#)
- [AN-9072 - Motion SPM® 45 Series Mounting Guidance](#)
- [RD-344 - Reference Design \(Three Shunt Solution\)](#)
- [RD-345 - Reference Design \(One Shunt Solution\)](#)

General Description

FNA41560 / FNA41560B2 is a Motion SPM® 45 module providing a fully-featured, high-performance inverter output stage for AC Induction, BLDC, and PMSM motors. These modules integrate optimized gate drive of the built-in IGBTs to minimize EMI and losses, while also providing multiple on-module protection features including under-voltage lockouts, over-current shutdown, thermal monitoring, and fault reporting. The built-in, high-speed HVIC requires only a single supply voltage and translates the incoming logic-level gate inputs to the high-voltage, high-current drive signals required to properly drive the module's robust short-circuit-rated IGBTs. Separate negative IGBT terminals are available for each phase to support the widest variety of control algorithms.

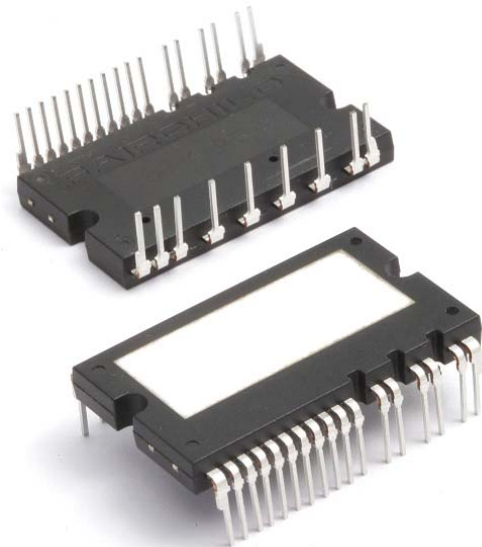

Figure 1. Package Overview

Package Marking and Ordering Information

| Device | Device Marking | Package | Packing Type | Quantity |
|------------|----------------|-----------|--------------|----------|
| FNA41560 | FNA41560 | SPMAA-A26 | Rail | 12 |
| FNA41560B2 | FNA41560B2 | SPMAA-C26 | Rail | 12 |

Integrated Power Functions

- 600 V - 15 A IGBT inverter for three-phase DC / AC power conversion (please refer to Figure 3)

Integrated Drive, Protection, and System Control Functions

- For inverter high-side IGBTs: gate drive circuit, high-voltage isolated high-speed level shifting control circuit Under-Voltage Lock-Out (UVLO) protection
- For inverter low-side IGBTs: gate drive circuit, Short-Circuit Protection (SCP) control supply circuit Under-Voltage Lock-Out (UVLO) protection
- Fault signaling: corresponding to UVLO (low-side supply) and SC faults
- Input interface: active-HIGH interface, works with 3.3 / 5 V logic, Schmitt trigger input

Pin Configuration



Figure 2. Top View

Pin Descriptions

| Pin Number | Pin Name | Pin Description |
|------------|-------------|---|
| 1 | V_{TH} | Thermistor Bias Voltage |
| 2 | R_{TH} | Series Resistor for the Use of Thermistor (Temperature Detection) |
| 3 | P | Positive DC-Link Input |
| 4 | U | Output for U-Phase |
| 5 | V | Output for V-Phase |
| 6 | W | Output for W-Phase |
| 7 | N_U | Negative DC-Link Input for U-Phase |
| 8 | N_V | Negative DC-Link Input for V-Phase |
| 9 | N_W | Negative DC-Link Input for W-Phase |
| 10 | C_{SC} | Capacitor (Low-Pass Filter) for Short-circuit Current Detection Input |
| 11 | V_{FO} | Fault Output |
| 12 | $IN_{(WL)}$ | Signal Input for Low-Side W-Phase |
| 13 | $IN_{(VL)}$ | Signal Input for Low-Side V-Phase |
| 14 | $IN_{(UL)}$ | Signal Input for Low-Side U-Phase |
| 15 | COM | Common Supply Ground |
| 16 | $V_{CC(L)}$ | Low-Side Common Bias Voltage for IC and IGBTs Driving |
| 17 | $V_{CC(H)}$ | High-Side Common Bias Voltage for IC and IGBTs Driving |
| 18 | $IN_{(WH)}$ | Signal Input for High-Side W-Phase |
| 19 | $IN_{(VH)}$ | Signal Input for High-Side V-Phase |
| 20 | $IN_{(UH)}$ | Signal Input for High-Side U-Phase |
| 21 | $V_{S(W)}$ | High-Side Bias Voltage Ground for W-Phase IGBT Driving |
| 22 | $V_{B(W)}$ | High-Side Bias Voltage for W-Phase IGBT Driving |
| 23 | $V_{S(V)}$ | High-Side Bias Voltage Ground for V-Phase IGBT Driving |
| 24 | $V_{B(V)}$ | High-Side Bias Voltage for V-Phase IGBT Driving |
| 25 | $V_{S(U)}$ | High-Side Bias Voltage Ground for U-Phase IGBT Driving |
| 26 | $V_{B(U)}$ | High-Side Bias Voltage for U-Phase IGBT Driving |

Internal Equivalent Circuit and Input/Output Pins



Figure 3. Internal Block Diagram

1st Notes:

1. Inverter high-side is composed of three IGBTs, freewheeling diodes, and one control IC for each IGBT.
2. Inverter low-side is composed of three IGBTs, freewheeling diodes, and one control IC for each IGBT. It has gate drive and protection functions.
3. Inverter power side is composed of four inverter DC-link input terminals and three inverter output terminals.

Absolute Maximum Ratings ($T_J = 25^\circ\text{C}$, unless otherwise specified.)

Inverter Part

| Symbol | Parameter | Conditions | Rating | Unit |
|------------------------|------------------------------------|--|------------|------------------|
| V_{PN} | Supply Voltage | Applied between P - N_U, N_V, N_W | 450 | V |
| $V_{PN(\text{Surge})}$ | Supply Voltage (Surge) | Applied between P - N_U, N_V, N_W | 500 | V |
| V_{CES} | Collector - Emitter Voltage | | 600 | V |
| $\pm I_C$ | Each IGBT Collector Current | $T_C = 25^\circ\text{C}, T_J < 150^\circ\text{C}$ | 15 | A |
| $\pm I_{CP}$ | Each IGBT Collector Current (Peak) | $T_C = 25^\circ\text{C}, T_J < 150^\circ\text{C}$, Under 1 ms Pulse Width | 30 | A |
| P_C | Collector Dissipation | $T_C = 25^\circ\text{C}$ per Chip | 41 | W |
| T_J | Operating Junction Temperature | (2nd Note 1) | - 40 ~ 150 | $^\circ\text{C}$ |

2nd Notes:

1. The maximum junction temperature rating of the power chips integrated within the Motion SPM® 45 product is 150°C.

Control Part

| Symbol | Parameter | Conditions | Rating | Unit |
|----------|----------------------------------|--|-----------------------|------|
| V_{CC} | Control Supply Voltage | Applied between $V_{CC(H)}, V_{CC(L)}$ - COM | 20 | V |
| V_{BS} | High - Side Control Bias Voltage | Applied between $V_{B(U)} - V_{S(U)}, V_{B(V)} - V_{S(V)}, V_{B(W)} - V_{S(W)}$ | 20 | V |
| V_{IN} | Input Signal Voltage | Applied between $IN_{(UH)}, IN_{(VH)}, IN_{(WH)}, IN_{(UL)}, IN_{(VL)}, IN_{(WL)}$ - COM | -0.3 ~ $V_{CC} + 0.3$ | V |
| V_{FO} | Fault Output Supply Voltage | Applied between V_{FO} - COM | -0.3 ~ $V_{CC} + 0.3$ | V |
| I_{FO} | Fault Output Current | Sink Current at V_{FO} pin | 1 | mA |
| V_{SC} | Current-Sensing Input Voltage | Applied between C_{SC} - COM | -0.3 ~ $V_{CC} + 0.3$ | V |

Bootstrap Diode Part

| Symbol | Parameter | Conditions | Rating | Unit |
|-----------|------------------------------------|--|-----------|------------------|
| V_{RRM} | Maximum Repetitive Reverse Voltage | | 600 | V |
| I_F | Forward Current | $T_C = 25^\circ\text{C}, T_J < 150^\circ\text{C}$ | 0.50 | A |
| I_{FP} | Forward Current (Peak) | $T_C = 25^\circ\text{C}, T_J < 150^\circ\text{C}$, Under 1 ms Pulse Width | 1.50 | A |
| T_J | Operating Junction Temperature | | -40 ~ 150 | $^\circ\text{C}$ |

Total System

| Symbol | Parameter | Conditions | Rating | Unit |
|-----------------------|--|---|-----------|------------------|
| $V_{PN(\text{PROT})}$ | Self-Protection Supply Voltage Limit (Short-Circuit Protection Capability) | $V_{CC} = V_{BS} = 13.5 \sim 16.5 \text{ V}$ $T_J = 150^\circ\text{C}$, Non-Repetitive, < 2 μs | 400 | V |
| T_{STG} | Storage Temperature | | -40 ~ 125 | $^\circ\text{C}$ |
| V_{ISO} | Isolation Voltage | 60 Hz, Sinusoidal, AC 1 Minute, Connect Pins to Heat Sink Plate | 2000 | V_{rms} |

Thermal Resistance

| Symbol | Parameter | Conditions | Min. | Typ. | Max. | Unit |
|----------------|-------------------------------------|---------------------------------------|------|------|------|-----------------------------|
| $R_{th(j-c)Q}$ | Junction to Case Thermal Resistance | Inverter IGBT Part (per 1 / 6 module) | - | - | 3.0 | $^\circ\text{C} / \text{W}$ |
| $R_{th(j-c)F}$ | | Inverter FWDi Part (per 1 / 6 module) | - | - | 4.3 | $^\circ\text{C} / \text{W}$ |

2nd Notes:

2. For the measurement point of case temperature (T_C), please refer to Figure 2.

Electrical Characteristics (T_J = 25°C, unless otherwise specified.)

Inverter Part

| Symbol | Parameter | Conditions | Min. | Typ. | Max. | Unit |
|----------------------|---|---|------|------|------|------|
| V _{CE(SAT)} | Collector - Emitter Saturation Voltage | V _{CC} = V _{BS} = 15 V V _{IN} = 5 V I _C = 15 A, T _J = 25°C | - | 1.8 | 2.3 | V |
| V _F | FWDI Forward Voltage | V _{IN} = 0 V I _F = 15 A, T _J = 25°C | - | 1.8 | 2.3 | V |
| HS | t _{ON} t _{C(ON)} t _{OFF} t _{C(OFF)} t _{rr} | Switching Times V _{PN} = 300 V, V _{CC} = V _{BS} = 15 V, I _C = 15 A T _J = 25°C V _{IN} = 0 V ↔ 5 V, Inductive Load (2nd Note 3) | 0.45 | 0.75 | 1.25 | μs |
| | | | - | 0.25 | 0.50 | μs |
| | | | - | 0.75 | 1.25 | μs |
| | | | - | 0.25 | 0.50 | μs |
| | | | - | 0.15 | - | μs |
| LS | t _{ON} t _{C(ON)} t _{OFF} t _{C(OFF)} t _{rr} | Switching Times V _{PN} = 300 V, V _{CC} = V _{BS} = 15 V, I _C = 15 A T _J = 25°C V _{IN} = 0 V ↔ 5 V, Inductive Load (2nd Note 3) | 0.45 | 0.75 | 1.25 | μs |
| | | | - | 0.25 | 0.50 | μs |
| | | | - | 0.75 | 1.25 | μs |
| | | | - | 0.25 | 0.50 | μs |
| | | | - | 0.15 | - | μs |
| I _{CES} | Collector - Emitter Leakage Current | V _{CE} = V _{CES} | - | - | 1 | mA |

2nd Notes:

3. t_{ON} and t_{OFF} include the propagation delay of the internal drive IC. t_{C(ON)} and t_{C(OFF)} are the switching time of IGBT itself under the given gate driving condition internally. For the detailed information, please see Figure 4.

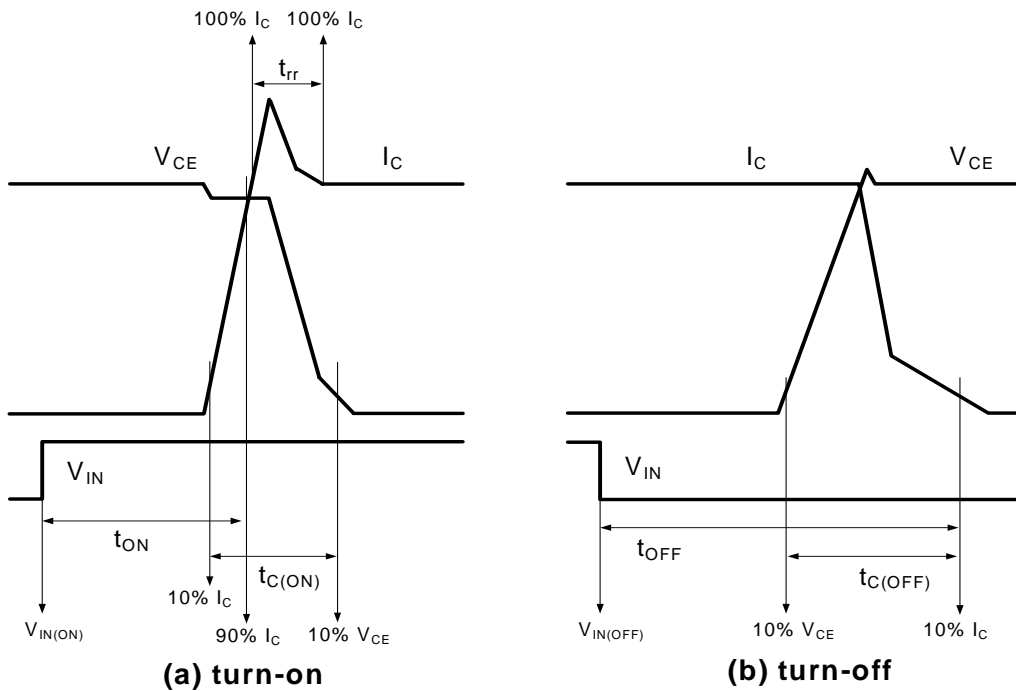

Figure 4. Switching Time Definition

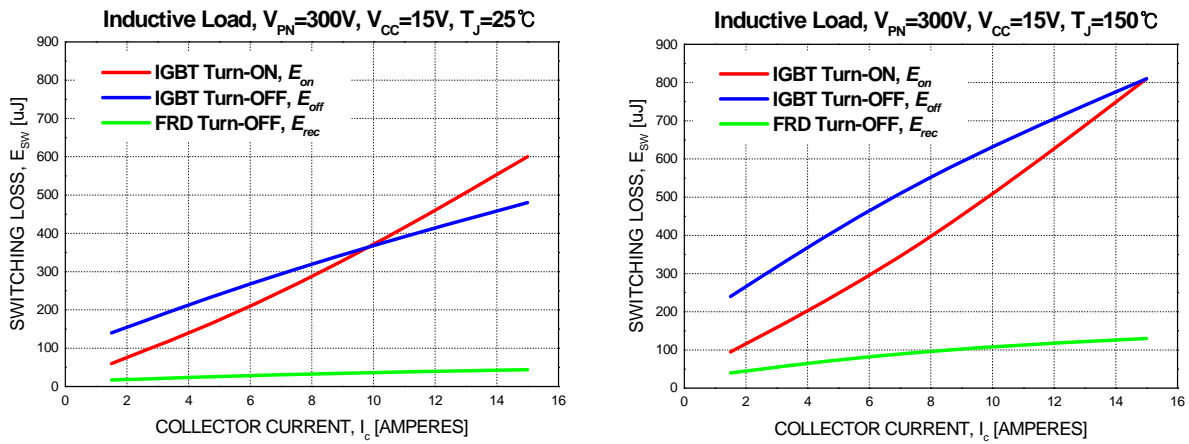

Figure 5. Switching Loss Characteristics (Typical)

Control Part

| Symbol | Parameter | Conditions | Min. | Typ. | Max. | Unit | |
|---------------|---|---|---|------|------|------|------------|
| I_{QCCH} | Quiescent V_{CC} Supply Current | $V_{CC(H)} = 15 V$, $I_{N(UH, VH, WH)} = 0 V$ | $V_{CC(H)} - COM$ | - | - | 0.10 | mA |
| I_{QCCL} | | $V_{CC(L)} = 15 V$, $I_{N(UL, VL, WL)} = 0 V$ | $V_{CC(L)} - COM$ | - | - | 2.65 | mA |
| I_{PCCH} | Operating V_{CC} Supply Current | $V_{CC(L)} = 15 V$, $f_{PWM} = 20 kHz$, duty = 50%, Applied to One PWM Signal Input for High-Side | $V_{CC(H)} - COM$ | - | - | 0.15 | mA |
| I_{PCCL} | | $V_{CC(L)} = 15 V$, $f_{PWM} = 20 kHz$, duty = 50%, Applied to One PWM Signal Input for Low-Side | $V_{CC(L)} - COM$ | - | - | 3.65 | mA |
| I_{QBS} | Quiescent V_{BS} Supply Current | $V_{BS} = 15 V$, $I_{N(UH, VH, WH)} = 0 V$ | $V_{B(U)} - V_{S(U)}$, $V_{B(V)} - V_{S(V)}$, $V_{B(W)} - V_{S(W)}$ | - | - | 0.30 | mA |
| I_{PBS} | Operating V_{BS} Supply Current | $V_{CC} = V_{BS} = 15 V$, $f_{PWM} = 20 kHz$, Duty = 50%, Applied to One PWM Signal Input for High-Side | $V_{B(U)} - V_{S(U)}$, $V_{B(V)} - V_{S(V)}$, $V_{B(W)} - V_{S(W)}$ | - | - | 2.00 | mA |
| V_{FOH} | Fault Output Voltage | $V_{SC} = 0 V$, V_{FO} Circuit: 10 k Ω to 5 V Pull-up | | 4.5 | - | - | V |
| V_{FOL} | | $V_{SC} = 1 V$, V_{FO} Circuit: 10 k Ω to 5 V Pull-up | | - | - | 0.5 | V |
| $V_{SC(ref)}$ | Short-Circuit Current Trip Level | $V_{CC} = 15 V$ (2nd Note 4) | | 0.45 | 0.50 | 0.55 | V |
| UV_{CCD} | Supply Circuit Under-Voltage Protection | Detection level | | 10.5 | - | 13.0 | V |
| UV_{CCR} | | Reset level | | 11.0 | - | 13.5 | V |
| UV_{BSD} | | Detection level | | 10.0 | - | 12.5 | V |
| UV_{BSR} | | Reset level | | 10.5 | - | 13.0 | V |
| t_{FOD} | Fault-Out Pulse Width | | | 30 | - | - | μs |
| $V_{IN(ON)}$ | ON Threshold Voltage | Applied between $I_{N(UH)}$, $I_{N(VH)}$, $I_{N(WH)}$, $I_{N(UL)}$, $I_{N(VL)}$, $I_{N(WL)} - COM$ | | - | - | 2.6 | V |
| $V_{IN(OFF)}$ | OFF Threshold Voltage | | | 0.8 | - | - | V |
| R_{TH} | Resistance of Thermister | @ $T_{TH} = 25^\circ C$, (2nd Note 5) | | - | 47 | - | k Ω |
| | | @ $T_{TH} = 100^\circ C$ | | - | 2.9 | - | k Ω |

2nd Notes:

- Short-circuit protection is functioning only at the low-sides.
- T_{TH} is the temperature of the thermister itself. To know case temperature (T_C), please make the experiment considering your application.



Figure. 6. R-T Curve of The Built-In Thermistor

Bootstrap Diode Part

| Symbol | Parameter | Conditions | Min. | Typ. | Max. | Unit |
|----------|-----------------------|---|------|------|------|------|
| V_F | Forward Voltage | $I_F = 0.1 \text{ A}, T_C = 25^\circ\text{C}$ | - | 2.5 | - | V |
| t_{rr} | Reverse-Recovery Time | $I_F = 0.1 \text{ A}, T_C = 25^\circ\text{C}$ | - | 80 | - | ns |

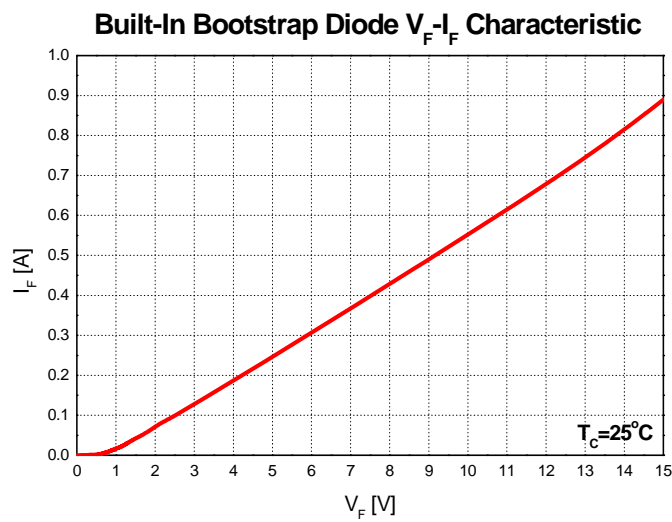

Figure 7. Built-In Bootstrap Diode Characteristic

2nd Notes:

- 6. Built-in bootstrap diode includes around 15 Ω resistance characteristic.

Recommended Operating Conditions

| Symbol | Parameter | Conditions | Min. | Typ. | Max. | Unit |
|--------------------------|--|---|------|------|------|-------------|
| V_{PN} | Supply Voltage | Applied between P - N_U, N_V, N_W | - | 300 | 400 | V |
| V_{CC} | Control Supply Voltage | Applied between $V_{CC(H)}, V_{CC(L)}$ - COM | 13.5 | 15.0 | 16.5 | V |
| V_{BS} | High-Side Bias Voltage | Applied between $V_{B(U)} - V_{S(U)}, V_{B(V)} - V_{S(V)}, V_{B(W)} - V_{S(W)}$ | 13.0 | 15.0 | 18.5 | V |
| $dV_{CC}/dt, dV_{BS}/dt$ | Control Supply Variation | | -1 | - | 1 | V / μ s |
| t_{dead} | Blanking Time for Preventing Arm-Short | For each input signal | 1.5 | - | - | μ s |
| f_{PWM} | PWM Input Signal | $-40^\circ\text{C} < T_J < 150^\circ\text{C}$ | - | - | 20 | kHz |
| V_{SEN} | Voltage for Current Sensing | Applied between N_U, N_V, N_W - COM (Including Surge-Voltage) | -4 | | 4 | V |
| $P_{WIN(ON)}$ | Minimum Input Pulse Width | (2nd Note 7) | 0.5 | - | - | μ s |
| $P_{WIN(OFF)}$ | | | 0.5 | - | - | |

2nd Notes:

7. This product might not make response if input pulse width is less than the recommended value.

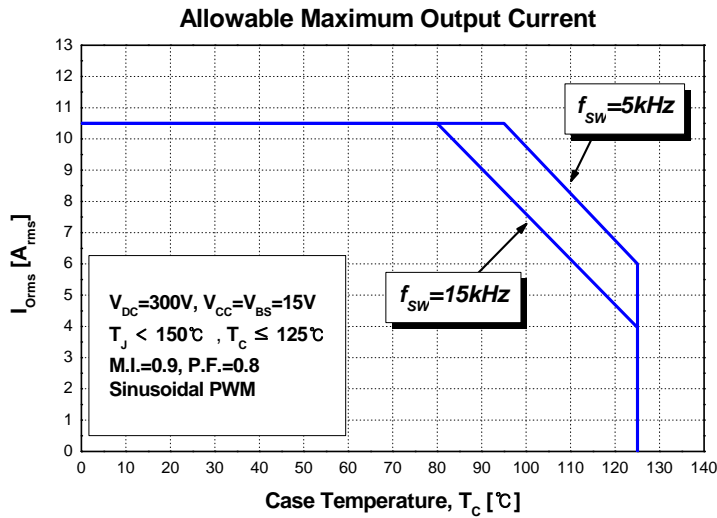

Figure 8. Allowable Maximum Output Current

2nd Notes:

8. This allowable output current value is the reference data for the safe operation of this product. This may be different from the actual application and operating condition.

Mechanical Characteristics and Ratings

| Parameter | Conditions | Min. | Typ. | Max. | Unit | |
|-----------------|--------------------|-------------------------|-------|-------|------|---------|
| Device Flatness | See Figure 9 | 0 | - | + 120 | μm | |
| Mounting Torque | Mounting Screw: M3 | Recommended 0.7 N • m | 0.6 | 0.7 | 0.8 | N • m |
| | See Figure 10 | Recommended 7.1 kg • cm | 6.2 | 7.1 | 8.1 | kg • cm |
| Weight | | - | 11.00 | - | g | |



Figure 9. Flatness Measurement Position

Pre - Screwing : 1→2

Final Screwing : 2→1



Figure 10. Mounting Screws Torque Order

2nd Notes:

- 9. Do not make over torque when mounting screws. Much mounting torque may cause ceramic cracks, as well as bolts and Al heat-sink destruction.
- 10. Avoid one side tightening stress. Figure 10 shows the recommended torque order for mounting screws. Uneven mounting can cause the ceramic substrate of the SPM® 45 package to be damaged. The pre-screwing torque is set to 20 ~ 30% of maximum torque rating.

Time Charts of Protective Function



- a1 : Control supply voltage rises: after the voltage rises UV_{CCR} , the circuits start to operate when next input is applied.
- a2 : Normal operation: IGBT ON and carrying current.
- a3 : Under-voltage detection (UV_{CCD}).
- a4 : IGBT OFF in spite of control input condition.
- a5 : Fault output operation starts.
- a6 : Under-voltage reset (UV_{CCR}).
- a7 : Normal operation: IGBT ON and carrying current.

Figure 11. Under-Voltage Protection (Low-Side)



- b1 : Control supply voltage rises: after the voltage reaches UV_{BSR} , the circuits start to operate when next input is applied.
- b2 : Normal operation: IGBT ON and carrying current.
- b3 : Under-voltage detection (UV_{BSD}).
- b4 : IGBT OFF in spite of control input condition, but there is no fault output signal.
- b5 : Under-voltage reset (UV_{BSR}).
- b6 : Normal operation: IGBT ON and carrying current.

Figure 12. Under-Voltage Protection (High-Side)

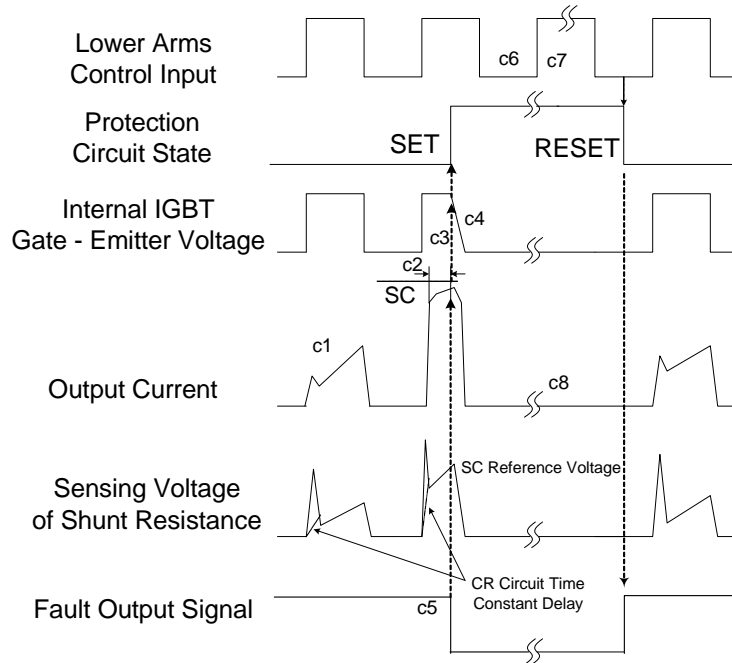

(with the external shunt resistance and CR connection)

- c1 : Normal operation: IGBT ON and carrying current.
- c2 : Short-circuit current detection (SC trigger).
- c3 : Hard IGBT gate interrupt.
- c4 : IGBT turns OFF.
- c5 : Input "LOW": IGBT OFF state.
- c6 : Input "HIGH": IGBT ON state, but during the active period of fault output, the IGBT doesn't turn ON.
- c7 : IGBT OFF state.

Figure 13. Short-Circuit Protection (Low-Side Operation Only)

Input/Output Interface Circuit



Figure 14. Recommended MCU I/O Interface Circuit

2nd Notes:

11. RC coupling at each input (parts shown dotted) might change depending on the PWM control scheme in the application and the wiring impedance of the application's printed circuit board. The input signal section of the Motion SPM® 45 product integrates a 5 kΩ (typ.) pull-down resistor. Therefore, when using an external filtering resistor, pay attention to the signal voltage drop at input terminal.

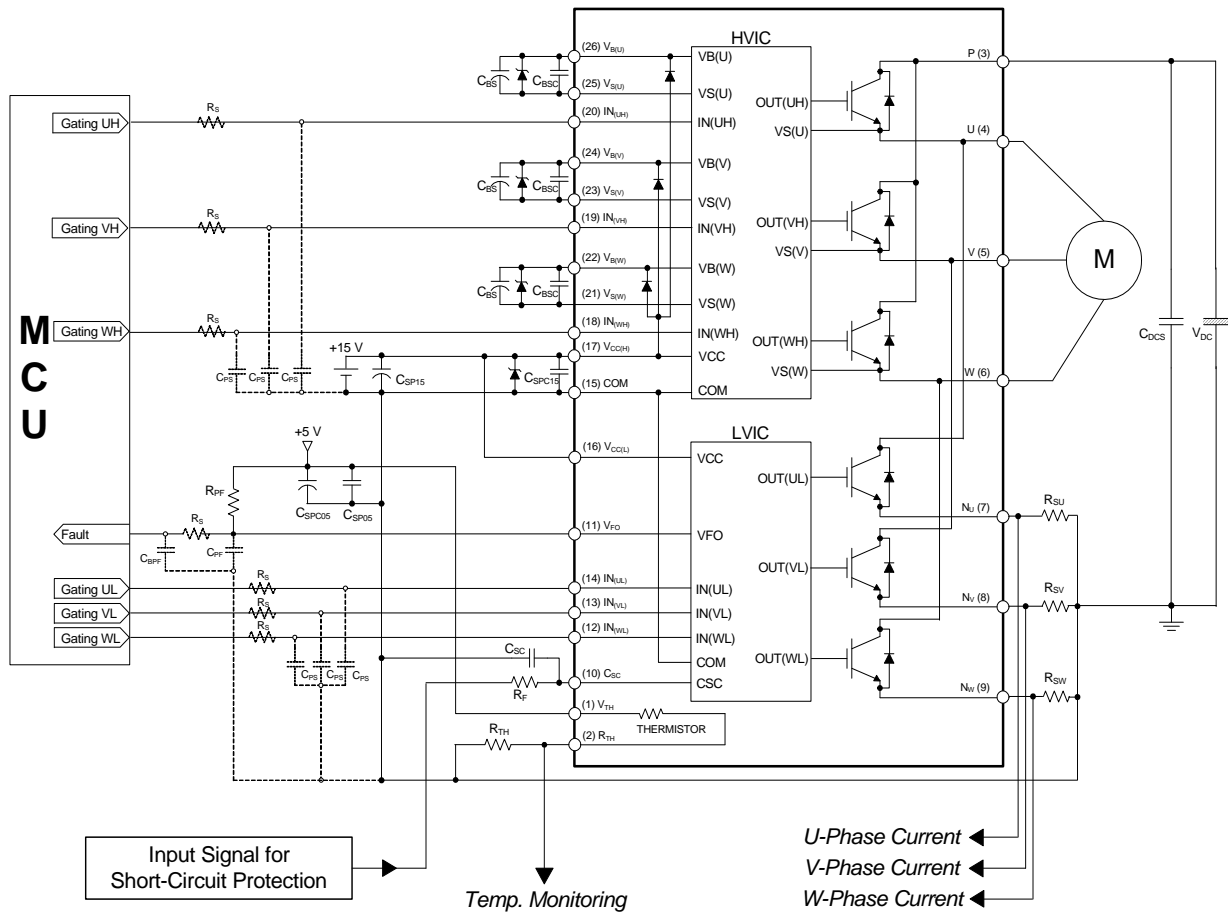
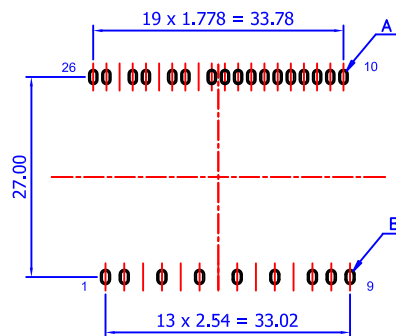

Figure 15. Typical Application Circuit

3rd Notes:

- 1) To avoid malfunction, the wiring of each input should be as short as possible (less than 2 - 3 cm).
- 2) By virtue of integrating an application-specific type of HVIC inside the Motion SPM® 45 product, direct coupling to MCU terminals without any optocoupler or transformer isolation is possible.
- 3) V_{FO} output is open-drain type. This signal line should be pulled up to the positive side of the MCU or control power supply with a resistor that makes I_{FO} up to 1 mA (please refer to Figure 14).
- 4) C_{SP15} of around seven times larger than bootstrap capacitor C_{BS} is recommended.
- 5) Input signal is active-HIGH type. There is a 5 k Ω resistor inside the IC to pull down each input signal line to GND. RC coupling circuits is recommended for the prevention of input signal oscillation. $R_S C_{PS}$ time constant should be selected in the range 50 ~ 150 ns (recommended $R_S = 100 \Omega$, $C_{PS} = 1$ nF).
- 6) To prevent errors of the protection function, the wiring around R_F and C_{SC} should be as short as possible.
- 7) In the short-circuit protection circuit, please select the $R_F C_{SC}$ time constant in the range 1.5 ~ 2 μ s.
- 8) The connection between control GND line and power GND line which includes the N_U , N_V , N_W must be connected to only one point. Please do not connect the control GND to the power GND by the broad pattern. Also, the wiring distance between control GND and power GND should be as short as possible.
- 9) Each capacitor should be mounted as close to the pins of the Motion SPM 45 product as possible.
- 10) To prevent surge destruction, the wiring between the smoothing capacitor and the P & GND pins should be as short as possible. The use of a high-frequency non-inductive capacitor of around 0.1 ~ 0.22 μ F between the P and GND pins is recommended.
- 11) Relays are used in almost every systems of electrical equipment in home appliances. In these cases, there should be sufficient distance between the MCU and the relays.
- 12) The zener diode or transient voltage suppressor should be adopted for the protection of ICs from the surge destruction between each pair of control supply terminals (recommended zener diode is 22 V / 1 W, which has the lower zener impedance characteristic than about 15 Ω).
- 13) Please choose the electrolytic capacitor with good temperature characteristic in C_{BS} . Also, choose 0.1 ~ 0.2 μ F R-category ceramic capacitors with good temperature and frequency characteristics in C_{BSC} .
- 14) For the detailed information, please refer to the AN-9070, AN-9071, AN-9072, RD-344, and RD-345.



- NOTES: UNLESS OTHERWISE SPECIFIED
- A) THIS PACKAGE DOES NOT COMPLY TO ANY CURRENT PACKAGING STANDARD
 - B) ALL DIMENSIONS ARE IN MILLIMETERS
 - C) DIMENSIONS ARE EXCLUSIVE OF BURRS, MOLD FLASH, AND TIE BAR EXTRUSIONS
 - D) () IS REFERENCE
 - E) [] IS ASS'Y QUALITY
 - F) DRAWING FILENAME: MOD26ACREV3

LAND PATTERN RECOMMENDATIONS



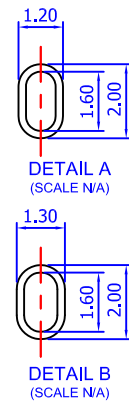
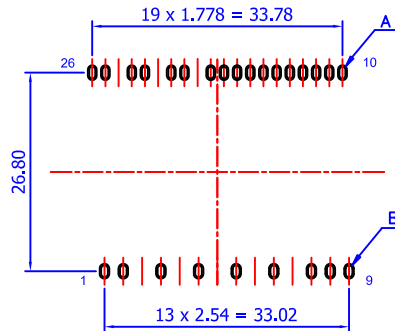
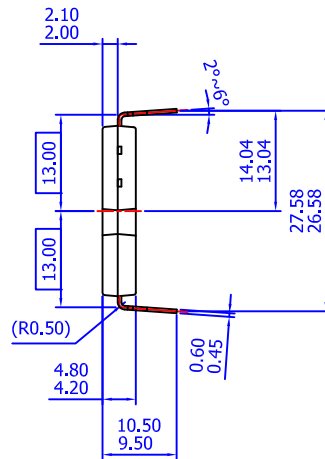

- NOTES: UNLESS OTHERWISE SPECIFIED
 A) THIS PACKAGE DOES NOT COMPLY TO ANY CURRENT PACKAGING STANDARD
 B) ALL DIMENSIONS ARE IN MILLIMETERS
 C) DIMENSIONS ARE EXCLUSIVE OF BURRS, MOLD FLASH, AND TIE BAR EXTRUSIONS
 D) () IS REFERENCE
 E) [] IS ASS'Y QUALITY
 F) DRAWING FILENAME: MOD26AAREV3

LAND PATTERN RECOMMENDATIONS



ON Semiconductor and  are trademarks of Semiconductor Components Industries, LLC dba ON Semiconductor or its subsidiaries in the United States and/or other countries. ON Semiconductor owns the rights to a number of patents, trademarks, copyrights, trade secrets, and other intellectual property. A listing of ON Semiconductor's product/patent coverage may be accessed at www.onsemi.com/site/pdf/Patent-Marking.pdf. ON Semiconductor reserves the right to make changes without further notice to any products herein. ON Semiconductor makes no warranty, representation or guarantee regarding the suitability of its products for any particular purpose, nor does ON Semiconductor assume any liability arising out of the application or use of any product or circuit, and specifically disclaims any and all liability, including without limitation special, consequential or incidental damages. Buyer is responsible for its products and applications using ON Semiconductor products, including compliance with all laws, regulations and safety requirements or standards, regardless of any support or applications information provided by ON Semiconductor. "Typical" parameters which may be provided in ON Semiconductor data sheets and/or specifications can and do vary in different applications and actual performance may vary over time. All operating parameters, including "Typicals" must be validated for each customer application by customer's technical experts. ON Semiconductor does not convey any license under its patent rights nor the rights of others. ON Semiconductor products are not designed, intended, or authorized for use as a critical component in life support systems or any FDA Class 3 medical devices or medical devices with a same or similar classification in a foreign jurisdiction or any devices intended for implantation in the human body. Should Buyer purchase or use ON Semiconductor products for any such unintended or unauthorized application, Buyer shall indemnify and hold ON Semiconductor and its officers, employees, subsidiaries, affiliates, and distributors harmless against all claims, costs, damages, and expenses, and reasonable attorney fees arising out of, directly or indirectly, any claim of personal injury or death associated with such unintended or unauthorized use, even if such claim alleges that ON Semiconductor was negligent regarding the design or manufacture of the part. ON Semiconductor is an Equal Opportunity/Affirmative Action Employer. This literature is subject to all applicable copyright laws and is not for resale in any manner.

PUBLICATION ORDERING INFORMATION

LITERATURE FULFILLMENT:

Literature Distribution Center for ON Semiconductor
19521 E. 32nd Pkwy, Aurora, Colorado 80011 USA
Phone: 303-675-2175 or 800-344-3860 Toll Free USA/Canada
Fax: 303-675-2176 or 800-344-3867 Toll Free USA/Canada
Email: orderlit@onsemi.com

N. American Technical Support: 800-282-9855 Toll Free
USA/Canada
Europe, Middle East and Africa Technical Support:
Phone: 421 33 790 2910
Japan Customer Focus Center
Phone: 81-3-5817-1050

ON Semiconductor Website: www.onsemi.com
Order Literature: <http://www.onsemi.com/orderlit>
For additional information, please contact your local
Sales Representative

Mouser Electronics

Authorized Distributor

Click to View Pricing, Inventory, Delivery & Lifecycle Information:

[ON Semiconductor:](#)

[FNA41560B2](#)