



SERIES TL 1100 SWITCHES

TACT SWITCHES - 12mm x 12mm

TACT SWITCHES

NAVIGATION SWITCHES

PUSHBUTTON SWITCHES

TOGGLE SWITCHES

ROCKER SWITCHES

SLIDE SWITCHES

SNAP-ACTION SWITCHES

DIP SWITCHES

KEYLOCK SWITCHES

ROTARY SWITCHES

DETECTOR SWITCHES

CAP. OPTIONS

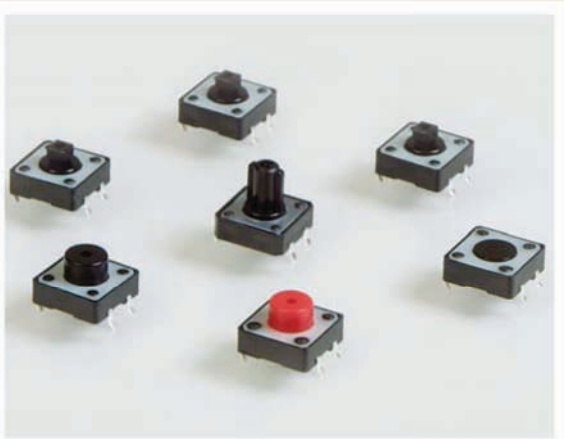

SPECIFICATIONS

Contact Rating:	50mA @ 12 VDC
Life Expectancy:	100,000 cycles
Contact Resistance:	100mΩ max., typical @ 2-4 VDC 100mA for both silver and gold plated contacts
Insulation Resistance:	100MΩ min.
Dielectric Strength:	250VAC
Actuation Force:	160± 50 gf, 260± 50 gf
Operating Temperature:	-20°C to 70°C
Travel:	0.3 Typ.

FEATURES & BENEFITS

- ▶ Reliable dome contact technology
- ▶ Strong tactile/audible feedback
- ▶ Multiple operating force options

APPLICATIONS/MARKETS

- ▶ Telecommunications
- ▶ Consumer Electronics
- ▶ Audio/visual
- ▶ Medical
- ▶ Testing/instrumentation
- ▶ Computer/servers/peripherals

HOW TO ORDER

SERIES	MODEL NO.	ACTUATOR ("L" Dimension)	OPERATING FORCE	CONTACT MATERIAL	CAP (Where Avail.)	CAP COLOR
TL	1100	(None)* = 3.3mm □ A = 3.8mm □ B = 4.554mm D = 4.3mm E = 7.5mm F = 12mm Right Angle Options C* = 6.45mm □ G = 11.2mm	F160 F260	Q = Silver R = Gold	See Cap Options *Caps available for these options only	

▶ ▶ ▶ Example Ordering Number
TL-1100-C-F260-Q-TAK-GRY

□ – Square Snap-on Actuator Head
"L" Dimension is 7.5mm

Specifications subject to change without notice.

TL 1100

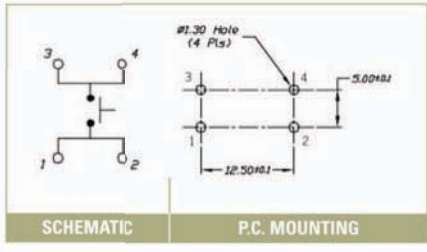
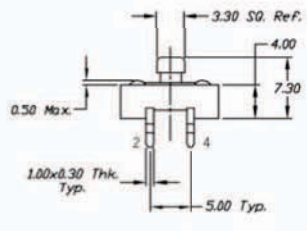
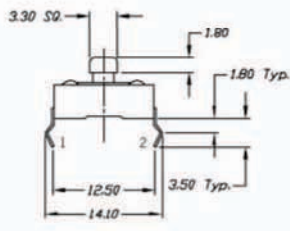



TL 1100 A

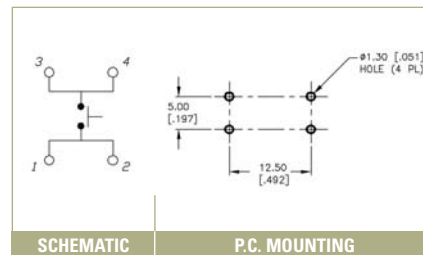
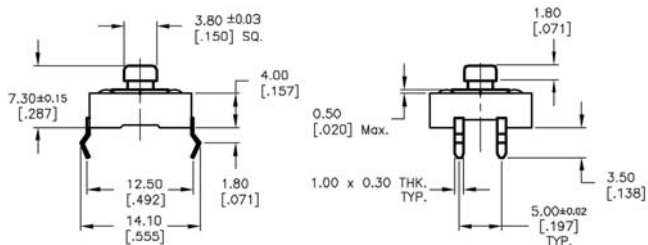

SCHEMATIC

P.C. MOUNTING

TL 1100 C

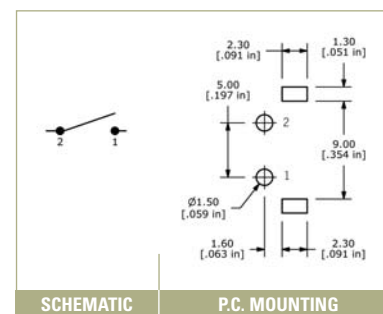
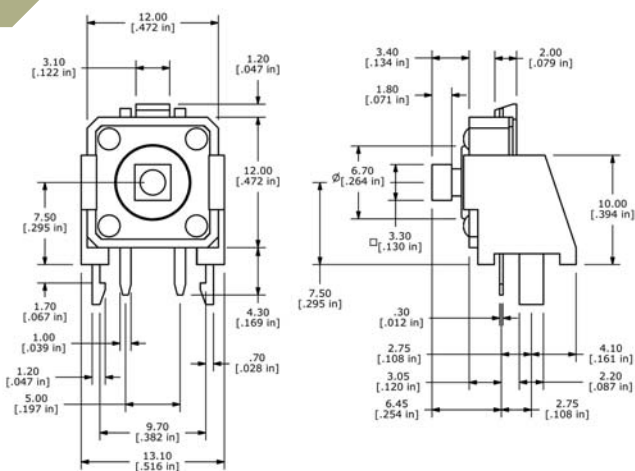

SCHEMATIC

P.C. MOUNTING

TL 1100 B & D

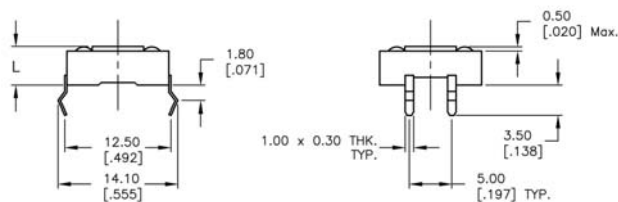

Actuator Length (L) in mm

B = 4.55mm

D = 4.3mm

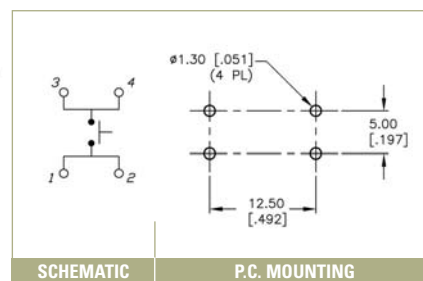

SCHEMATIC

P.C. MOUNTING

TL 1100 E

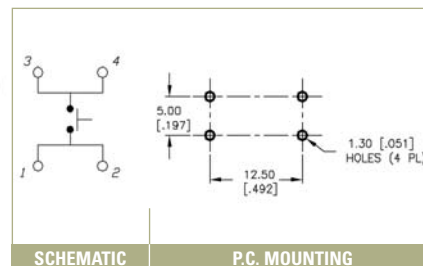
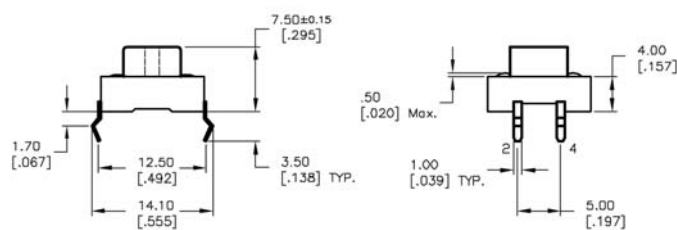

SCHEMATIC

P.C. MOUNTING



SERIES TL1100 SWITCHES

TACT SWITCHES - 12mm x 12mm

TACT SWITCHES

NAVIGATION SWITCHES

PUSHBUTTON SWITCHES

TOGGLE SWITCHES

ROCKER SWITCHES

SLIDE SWITCHES

SNAP-ACTION SWITCHES

DIP SWITCHES

KEYLOCK SWITCHES

ROTARY SWITCHES

DETECTOR SWITCHES

CAP OPTIONS

TL 1100 F

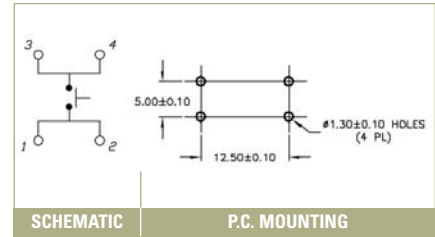
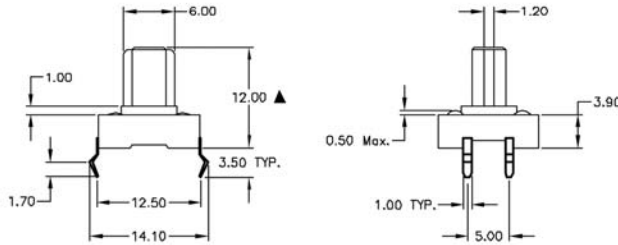

TL 1100 G

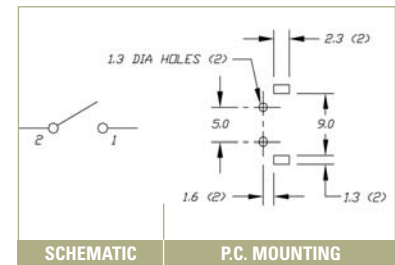
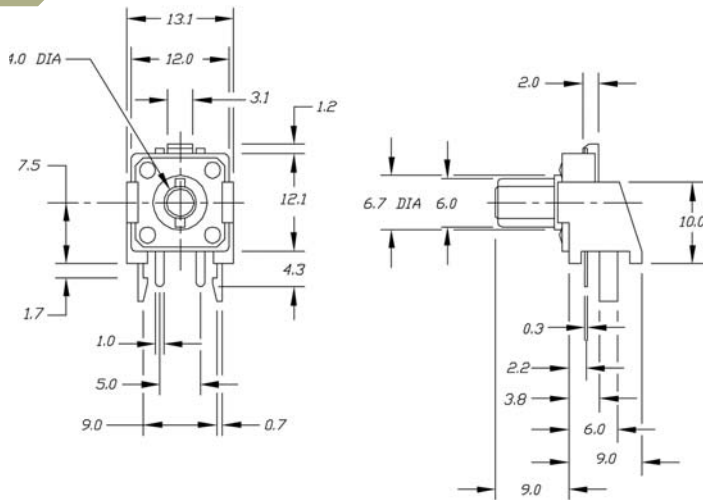

Mouser Electronics

Authorized Distributor

Click to View Pricing, Inventory, Delivery & Lifecycle Information:

E-Switch:

[TL1100CF160Q](#) [TL1100GF160Q](#) [TL1100DF160Q](#) [TL1100FF160Q](#) [TL1100EF160Q](#) [TL1100BF160Q](#)
[TL1100F160Q6JBLK](#) [TL1100F260Q](#) [TL1100F160Q](#) [TL1100TF260Q](#) [TL1100TF260R](#) [TL1100EF160QSSDOME](#)
[TL1100EF260Q](#) [TL1100F260Q4JWHT](#) [TL1100AF160Q](#) [TL1100BF260Q](#) [TL1100CF160Q.08BLK](#)
[TL1100CF160Q.08RED](#) [TL1100CF160Q.09BLU](#) [TL1100CF160Q.09GRY](#) [TL1100CF160Q4JBLK](#)
[TL1100CF160Q4JGRY](#) [TL1100CF160Q5JGRY](#) [TL1100CF160Q6JBLK](#) [TL1100CF260Q.08RED](#) [TL1100DF260Q](#)
[TL1100F160Q4JBLK](#) [TL1100F160Q4JWHT](#) [TL1100F160Q5JBLK](#) [TL1100F160Q6JGRY](#) [TL1100F160Q6JRED](#)
[TL1100F260Q4JBLK](#) [TL1100F260Q4JGRY](#) [TL1100F260Q5JBLK](#) [TL1100F260Q5JBLU](#) [TL1100F260R](#)
[TL1100RF260Q](#) [TL1100SF260Q](#) [TL1100F260Q6JGRY](#) [TL1100CF260R](#)