

THIS DRAWING IS UNPUBLISHED. RELEASED FOR PUBLICATION
 © COPYRIGHT - By - ALL RIGHTS RESERVED.

REVISIONS					
P	LTR	DESCRIPTION	DATE	DWN	APVD
	R	REVISED PER ECR-16-000368	05APR2016	T.Q	W.H

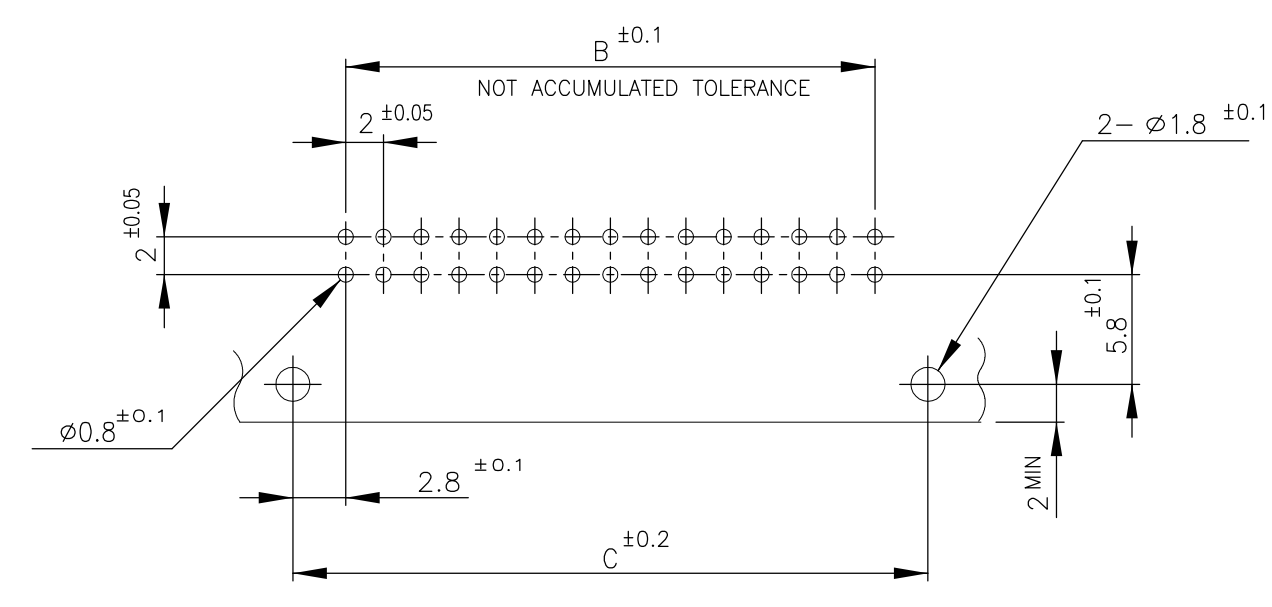
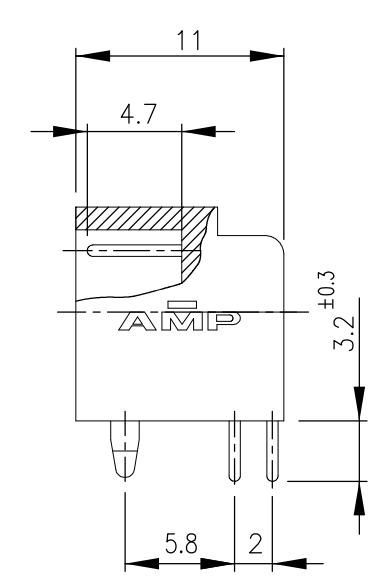
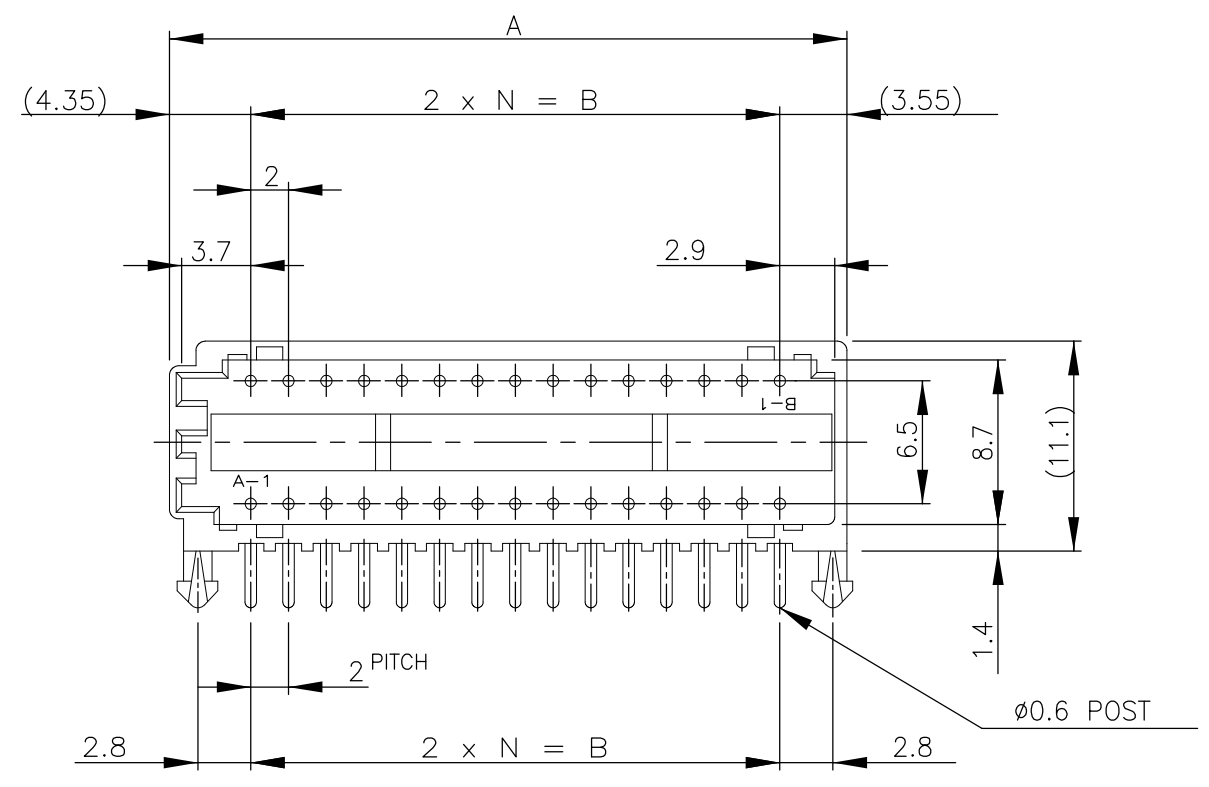

NOTE

- MATERIAL : HOUSING / 66 NYLON UL94V-0 NATURAL
 Ø0.6 POST / TIN BRASS 3/4 H

RECOMMENDABLE P.C.B MOUNTING DIMENSIONS
 (PCB THK=1.6)

TOLERANCES UNLESS OTHERWISE SPECIFIED:

10 ≥ *	:	±0.2
30 ≥ * > 10	:	±0.25
100 ≥ * > 30	:	±0.3
ANGLE	:	±3°

THIS DRAWING IS A CONTROLLED DOCUMENT.	
DIMENSIONS: mm	TOLERANCES UNLESS OTHERWISE SPECIFIED:
	0 PLC ± -
	1 PLC ± -
	2 PLC ± -
	3 PLC ± -
	4 PLC ± -
	ANGLES ± -
MATERIAL SEE NOTE	FINISH SEE NOTE

DWN	S.XU	31JAN03
CHK	S.YAO	31JAN03
APVD	T. SASAKI	31JAN03
PRODUCT SPEC	108-60020	
APPLICATION SPEC	-	
WEIGHT	0.000000	
CUSTOMER DRAWING		

35.9	28	33.6	14	30	3-292138-0
33.9	26	31.6	13	28	2- -8
31.9	24	29.6	12	26	2- -6
29.9	22	27.6	11	24	2- -4
27.9	20	25.6	10	22	2- -2
25.9	18	23.6	9	20	2- -0
23.9	16	21.6	8	18	1- -8
21.9	14	19.6	7	16	1-292138-6
A	B	C	N	POS	P/N



POST HEADER (HORIZONTAL)
 CT DOUBLE ROW CONNECTOR

SIZE	CAGE CODE	DRAWING NO	RESTRICTED TO
A3	00779	C-292138	-
SCALE	SHEET	REV	
NTS	1 OF 1	R	

Mouser Electronics

Authorized Distributor

Click to View Pricing, Inventory, Delivery & Lifecycle Information:

[TE Connectivity:](#)

[2-292138-4](#)