

61ZE01PS  
(ON ENVIROM) 台機理図

REFERENCE ONLY  
JAE

版数 REV.	年月日 DATE	DCN NO.	変更内容 DESCRIPTION	製図 DR.	担当 CHK.	査閲 APPD.	承認 APPD.

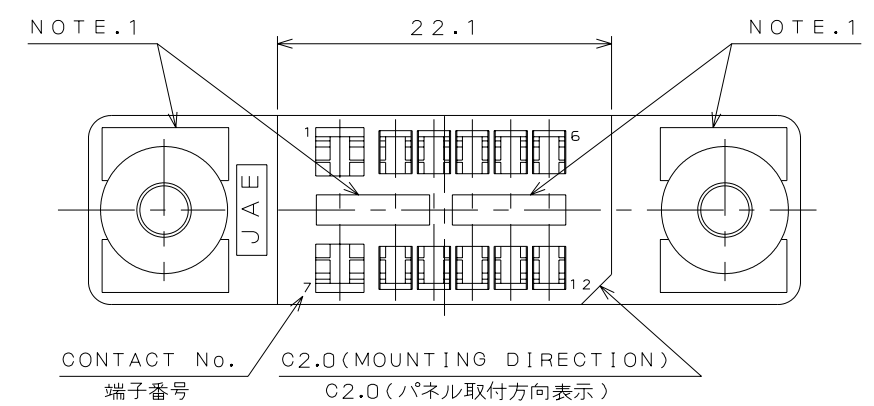
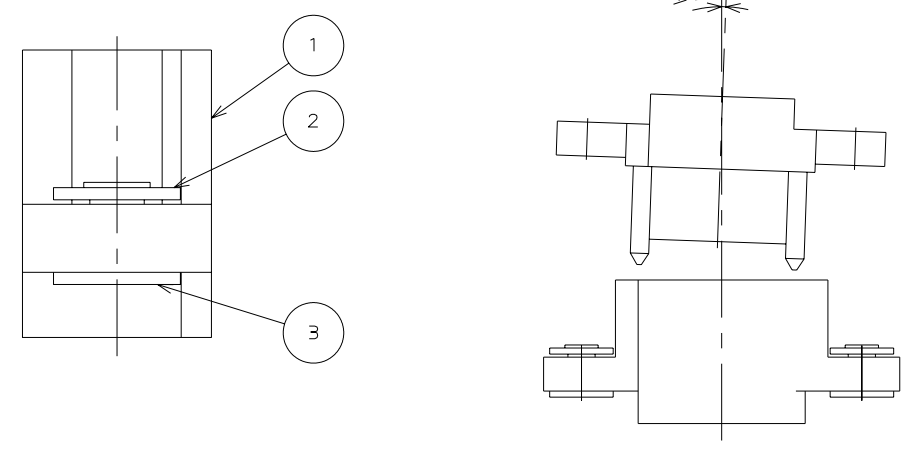
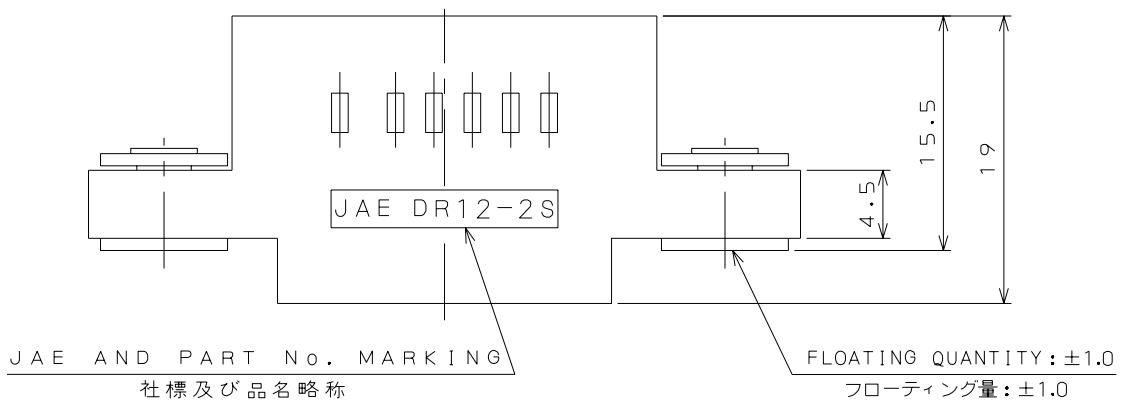
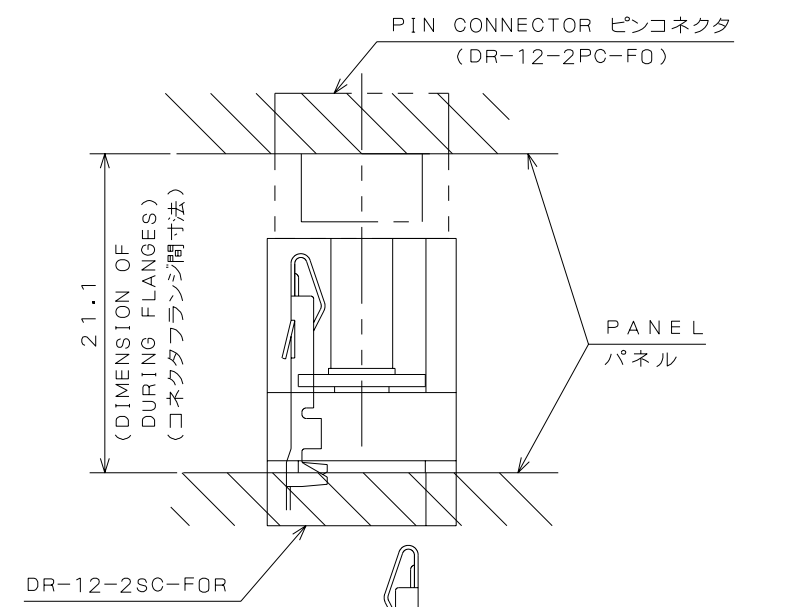
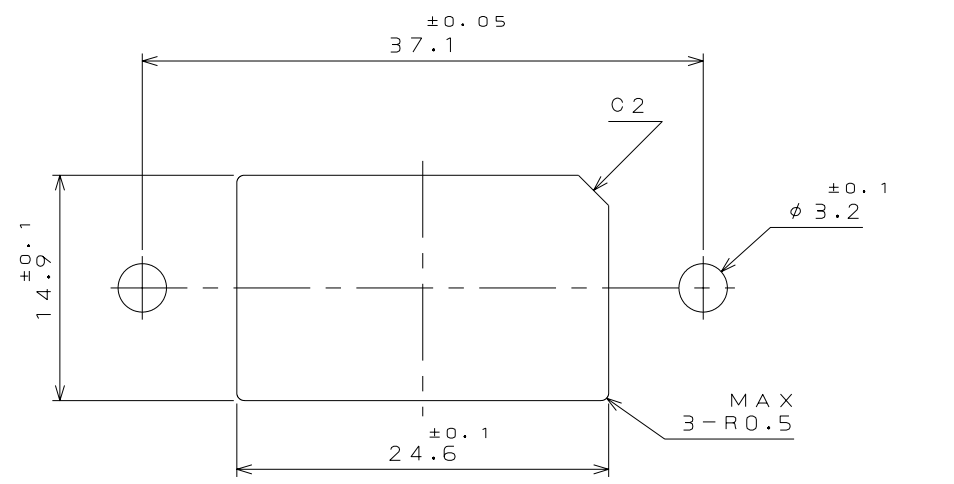
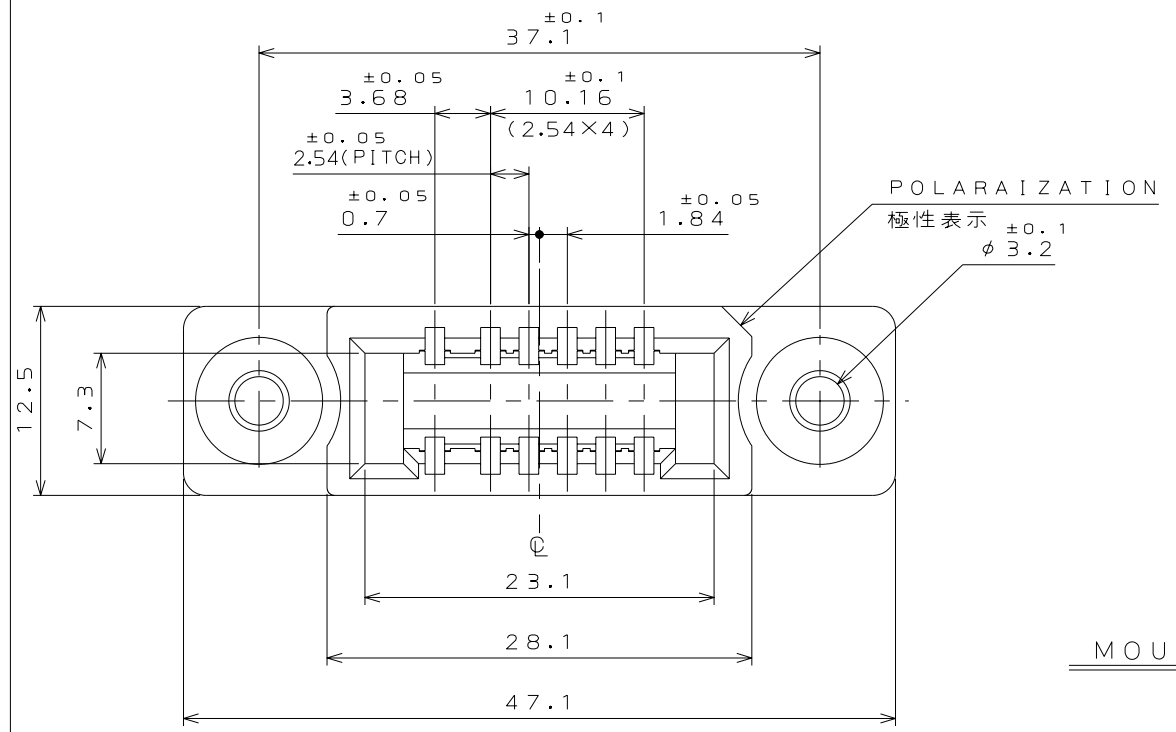

NOTE.1 ADD SHAPES IMPROVING PRODUCTIVITY.  
注1. 図示の位置にヒケ逃げを設ける。

符号 NO.	名称 DESCRIPTION	個数 QTY.	材料 MATERIAL	仕上 FINISH	備考 REMARKS
3	FLOATING RIVET	2	COPPER ALLOY	NICKEL PLATED	
2	WASHER	2	COPPER ALLOY	NICKEL PLATED	
1	INSULATOR	1	GLASS FILLED PBT (COLOR: BLACK)	UL94V-0	
仕様書 (SPECIFICATION) JACS-3063-1 T86-12		第1版 (ORIGINAL DATE) 5.Jul.2005		尺度 (SCALE) 2:1	シリーズ (SERIES) DR
一般公差 (GENERAL TOLERANCE)		製図 DR.		名称 (TITLE) DR-12-2SC-F0R	
寸法 (DIMENSION)		担当 CHK. Y.TAKAGI			
角度 (ANGLES)		査閲 APPD.			
. $\pm 0.8$ .X $\pm 0.4$ .XX $\pm 0.1$ .XXX $\pm$		承認 APPD. Y.KUBOTA			
		質量 (MASS)			

日本航空電子工業株式会社  
JAPAN AVIATION ELECTRONICS INDUSTRY, LTD.  
JAE

図面番号 (DRAWING NO.)  
SJ103219  
版数 (REV.)  
1

DCF-C-212E(03.08)

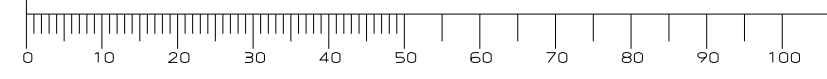

# Mouser Electronics

Authorized Distributor

Click to View Pricing, Inventory, Delivery & Lifecycle Information:

[JAE Electronics:](#)

[DR-12-2SC-F0R](#)