

# 13~25A Compatible, Position Misalignment Absorption Type Power Supply Connector for PCB Connections

## FX30B Series

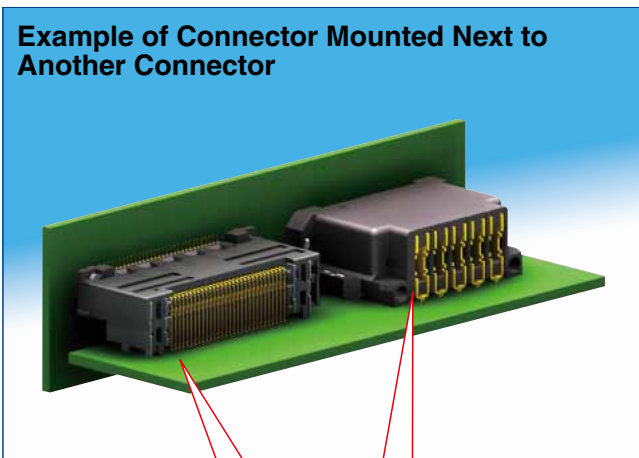

FX18 Series  
(without position misalignment absorption function)

FX30B Series  
(with position misalignment absorption function)

### ■ Features

1. **Contact Pitch : 3.81mm , 7.62mm**
2. **Current Capacity : 13~25A/pin (Page 2.)**  
\*For details, see the derating curve.(Described on page 4.)
3. **Connection Type: Coplanar / Vertical / Parallel**
4. **Number of Pos. : 2 / 3 / 4 / 5 Pos.**
5. **Position Misalignment Absorption Movable Amount: ±0.3mm**  
(1)Reliable to mounting misalignment when using multiple connectors.  
(2)Other products without position misalignment absorption can be used together.
6. **Effective Mating Length : 2mm**  
The effective mating length is 2mm long, so it has an enough margin for the mating stroke. (3.0mm for longer contacts)
7. **Multi-point Contact Structure**  
It has superior contact reliability by employing an independent four-point contact spring structure.
8. **Low Insertion / Extraction Force**  
It offers low insertion/extraction force by employing a two-step contact timing sequence.
9. **Robustness**  
Reinforcement metal fittings that securely fix the connector to the PCB are added on both sides of the connector, providing excellent deformation resistance for up, down, left and right directions.
10. **Large Guide Form Leads Superior Mating Ability**  
A large induction form has been provided, allowing easy mating operations. (Induction amount : ±1.3 mm, with position misalignment absorption amount : ±1.6mm)
11. **Protected structure**  
Our proprietary protective wall prevents foreign materials from contacting the sensitive areas. (Compatible to JIS C 0922 Probes for verification B)
12. **UL, C-UL and TÜV certifications have been achieved.**

### ■ Mating variations

#### Coplanar connection type

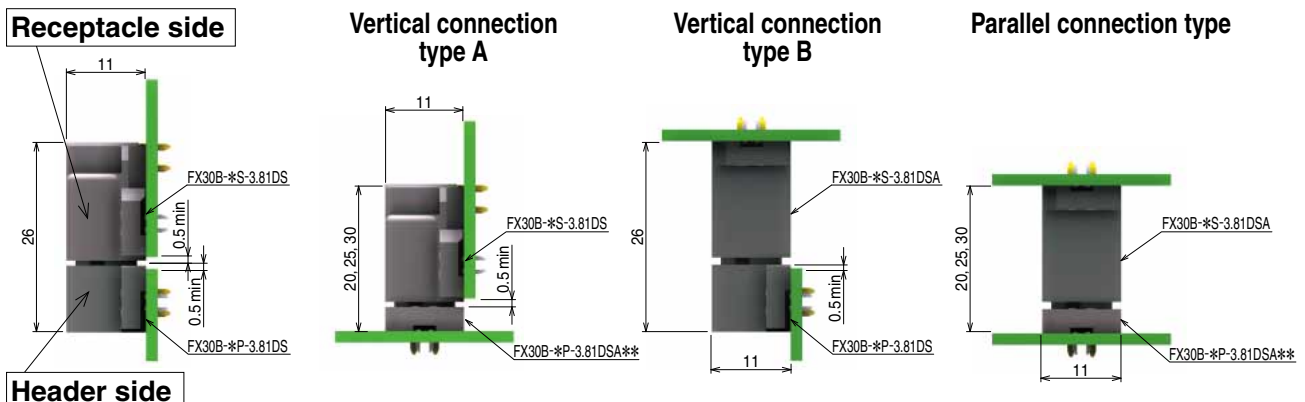

## Product Specifications

FULL CONTACT TYPE (P=3.81mm)		2 pos.	3 pos.	4 pos.	5 pos.		
Ratings	Current rating (Note 3)	Ambient temp 25°C	23A	22A	20A	20A	Operating temperature range : -55 to +105°C (Note 1)
		UL/C-UL	16A	15A	13A	13A	
	TÜV	17A	16A	15A	15A		
Voltage rating	UL/C-UL	250V		AC/DC		Operating humidity range : Relative humidity 85% max. (Not dewed)	
	TÜV	150V		AC/DC			
SKIPPED CONTACT TYPE (P=7.62mm)		2 pos.	3 pos.				
Ratings	Current rating (Note 3)	Ambient temp 25°C	25A		24A		Storage temperature range : -10 to +60°C (Note 2)
		UL/C-UL	18A		16A		
	TÜV	19A		18A			
Voltage rating	UL/C-UL	600V		AC/DC		Storage humidity range : 40% to 70% (Note 2)	
	TÜV						
UL/C-UL/TÜV		UL/C-UL	E52653		(Acc. to UL1977 / CSA C22.2 No.182.3-M1987)		
File No. and Confirmation No.		TÜV	R50275872		(Acc. to EN61984 : 2009)		

Item	Specification	Conditions
1. Contact resistance	2mΩ or less	Measured at 10 mA
2. Insulation resistance	1000MΩ or more	Measured at 250 V DC
3. Withstanding voltage	No flashover or breakdown	Conduct electricity by applying a voltage of 750 V AC for 1 minute
4. Insertion/extraction lifespan	Contact resistance : 5 mΩ or less	Insert/extract 100 times
5. Vibration resistance	No electric outage of 1μs or greater	Frequency : 10 to 55Hz, half amplitude : 0.75mm, 10 cycles in each of 3 axis directions for 5 minutes/cycle
6. Shock resistance	No electric outage of 1μs or greater	Acceleration of 490 m/s <sup>2</sup> , duration 11 ms, sine half-wave, 3 cycles in each of the 3 axes each in both directions
7. Humidity resistance	Contact resistance : 5mΩ or less Insulation resistance : 1000MΩ or more	Temperature : 40°C, humidity : 90 to 95%, left for 96 hours
8. Temperature cycle	Contact resistance : 5mΩ or less Insulation resistance : 1000MΩ or more	Temperature : -55 → 105°C Time : 30 → 30 min., 5 cycles
9. Solder heat resistance	No melting of resin part, which affects the product performance	Solder tank : solder tank temperature : 260°C, 10 seconds Manual soldering : soldering iron temperature : 380°C, 10 seconds

Note 1 : Includes temperature rise caused by current flow.

Note 2 : The term "storage" refers to the long-term storage condition of unused products before PCB mounting.

Note 3 : Current rating per 1 contact is used.

## Materials / Finish

### ●Receptacle/Header Common

Part	Material	Color/Finish	Specification
Insulator	Polyamide resin	Black	UL94V-0
Power supply contact	Copper alloy	Contact area : Gold plating Mounting area : Pure tin plating	—
Reinforcement metal fitting	Phosphorous bronze	Whole body : Pure tin plating	—

## Product Number Structure

Refer to the chart below when determining the product specifications from the product number.

Please select from the product numbers listed in this catalog when placing orders.

### ●Receptacle

**FX30B - 5 S - 3.81 DS**

①      ② ③      ④      ⑤

### ●Header

**FX30B - 5 P - 3.81 DSA 20**

①      ② ③      ④      ⑤      ⑥

### ●Receptacle (One pin skipped type)

**FX30B - 3 S - 7.62 DS**

①      ② ③      ④      ⑤

### ●Header (One pin skipped type)

**FX30B - 3 P - 7.62 DSA 20**

①      ② ③      ④      ⑤      ⑥

① Series Name	FX30B
② Number of Contacts	2 to 5
③ Connector Type	S : Receptacle type P : Header type
④ Contact Pitch	3.81mm
⑤ Product Type	DS : Right angle type DSA : Straight type
⑥ Stacking Height Type	

## Functional diagram

### ● Right angle receptacle



### ● Right angle header



Coplanar connection

Vertical connection

### ● Straight receptacle



### ● Straight header



Parallel connection

## Stacking height dimensions for parallel connection type

### Stacking height combinations table

	FX30B-*P-3.81DSA20 FX30B-*P-7.62DSA20	FX30B-*P-3.81DSA25 FX30B-*P-7.62DSA25	FX30B-*P-3.81DSA30 FX30B-*P-7.62DSA30
FX30B-*S-3.81DSA FX30B-*S-7.62DSA	20mm	25mm	30mm

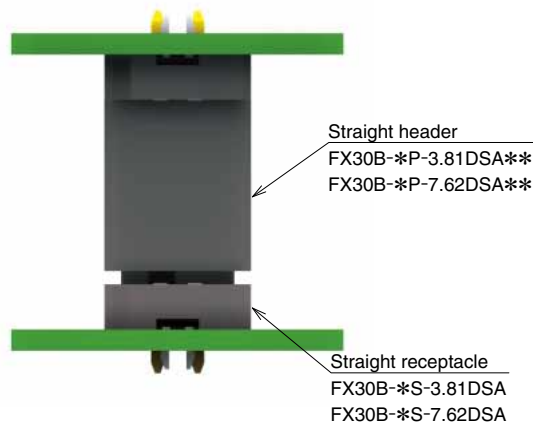

◆ Derating curve ● Normal type

(Electricity conducted through the 5 pins of 5-pin coplanar connection type connector)

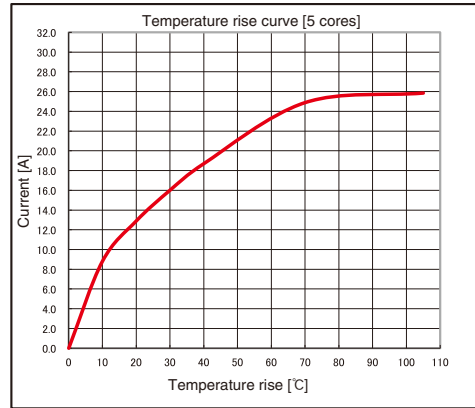
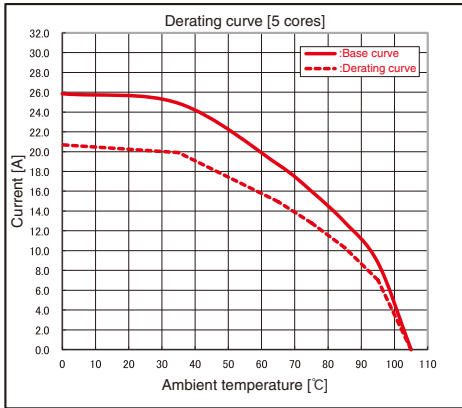

(Electricity conducted through the 4 pins of 4-pin coplanar connection type connector)

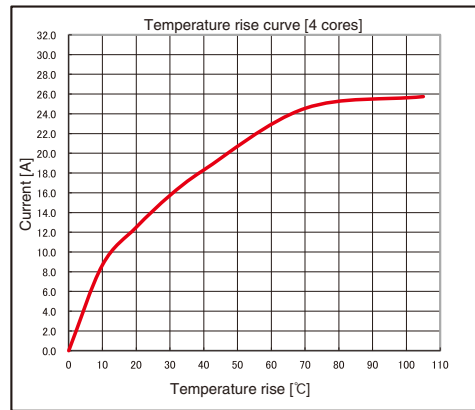
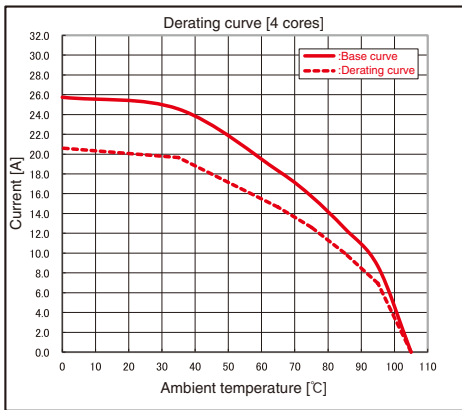

(Electricity conducted through the 3 pins of 3-pin coplanar connection type connector)

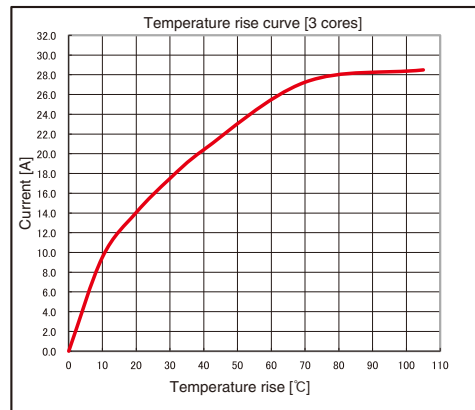
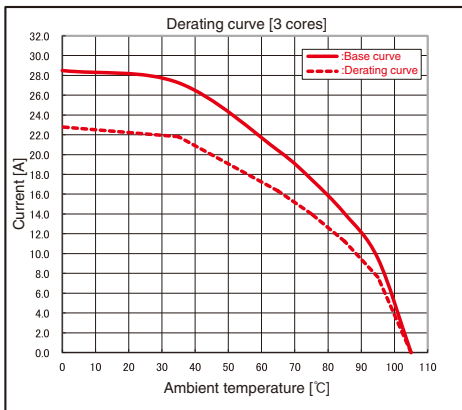

(Electricity conducted through the 2 pins of 2-pin coplanar connection type connector)

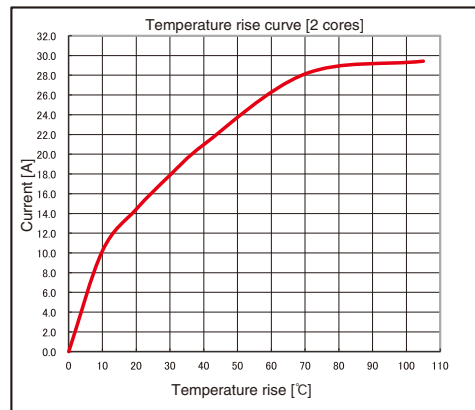
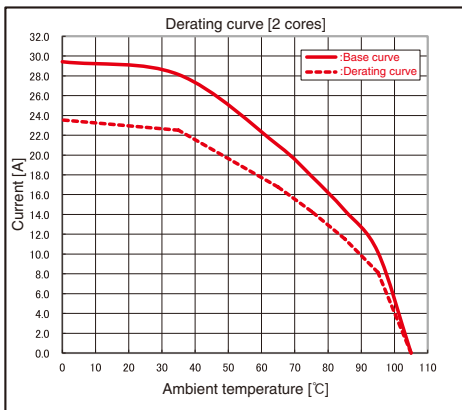

Note: The derating curve is created by multiplying a derating factor of 0.8 to the current value of the base curve.

◆ **Derating curve** ● One pin skipped type

(Electricity conducted through the 3 pins of 3-pin coplanar connection type connector)

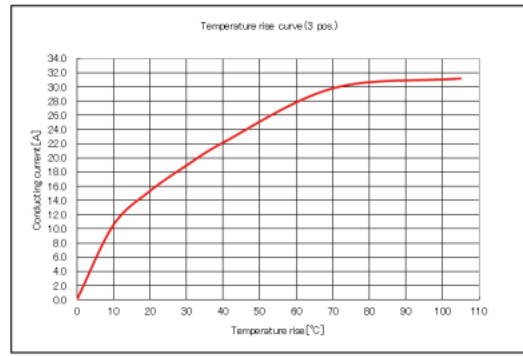
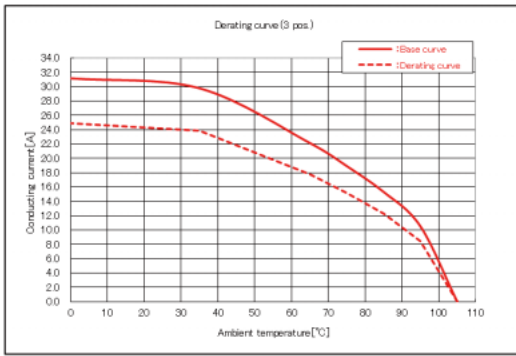

(Electricity conducted through the 2 pins of 2-pin coplanar connection type connector)

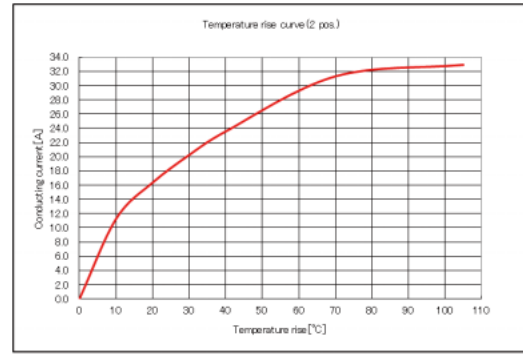
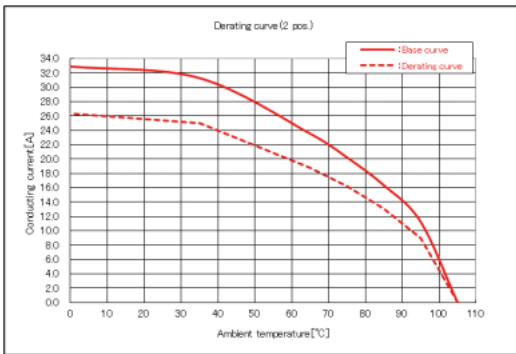

Note: The derating curve is created by multiplying a derating factor of 0.8 to the current value of the base curve.

●Right angle receptacle (S-DS type)

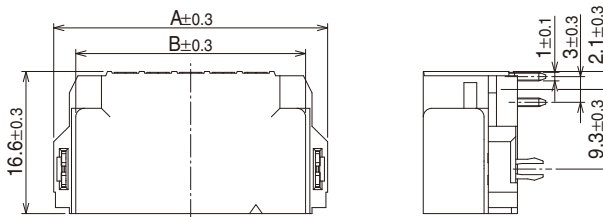

◆Diagram of recommended PCB layout dimensions

(Note) PCB thickness : t= 1.6mm

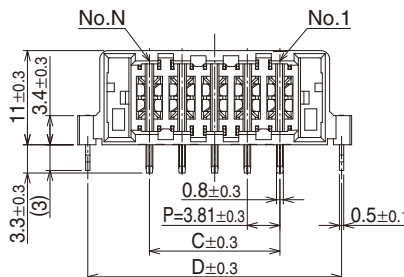
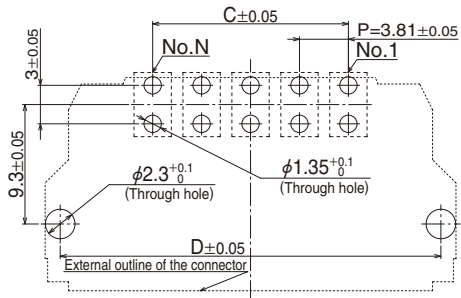

Unit : mm

Part No.	HRS No.	A	B	C	D	N (No. of Contacts)
FX30B-2S-3.81DS	570-3600-6 00	20.56	15.41	3.81	18.21	2
FX30B-3S-3.81DS	570-3601-9 00	24.37	19.22	7.62	22.02	3
FX30B-4S-3.81DS	570-3602-1 00	28.18	23.03	11.43	25.83	4
FX30B-5S-3.81DS	570-3603-4 00	31.99	26.84	15.24	29.64	5

●Straight receptacle (S-DSA type)

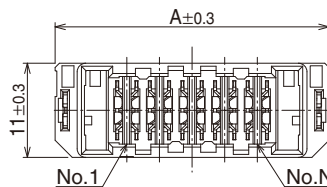

◆Diagram of recommended PCB layout dimensions

(Note) PCB thickness : t= 1.6mm

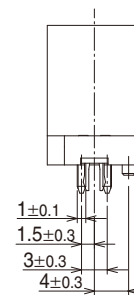
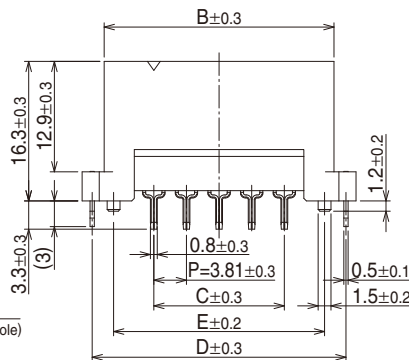
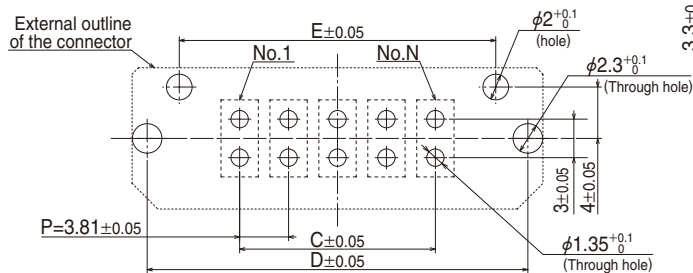

Unit : mm

Part No.	HRS No.	A	B	C	D	E	N (No. of Contacts)
FX30B-2S-3.81DSA	570-3500-1 00	20.56	15.41	3.81	18.21	13.21	2
FX30B-3S-3.81DSA	570-3501-4 00	24.37	19.22	7.62	22.02	17.02	3
FX30B-4S-3.81DSA	570-3502-7 00	28.18	23.03	11.43	25.83	20.83	4
FX30B-5S-3.81DSA	570-3503-0 00	31.99	26.84	15.24	29.64	24.64	5

●Right angle header (P-DS type)

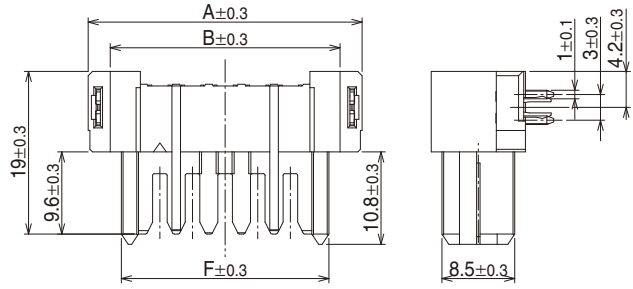

◆Diagram of recommended PCB layout dimensions

(Note) PCB thickness : t= 1.6mm

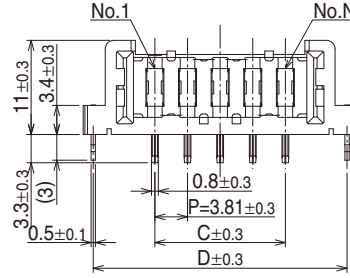
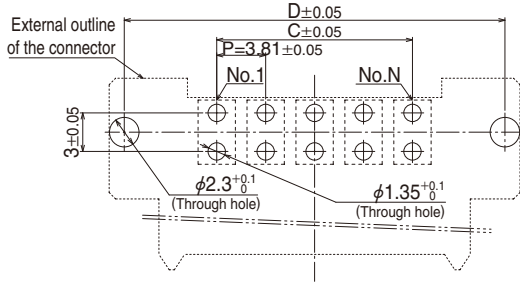

Unit : mm

Part No.	HRS No.	A	B	C	D	F	N (No. of Contacts)
FX30B-2P-3.81DS	570-3400-7 00	20.56	15.41	3.81	18.21	12.81	2
FX30B-3P-3.81DS	570-3401-0 00	24.37	19.22	7.62	22.02	16.62	3
FX30B-4P-3.81DS	570-3402-2 00	28.18	23.03	11.43	25.83	20.43	4
FX30B-5P-3.81DS	570-3403-5 00	31.99	26.84	15.24	29.64	24.24	5

●Straight header - 20 (P-DSA20 type)

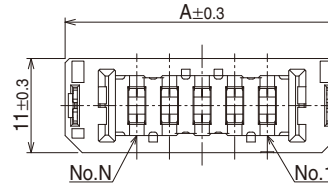
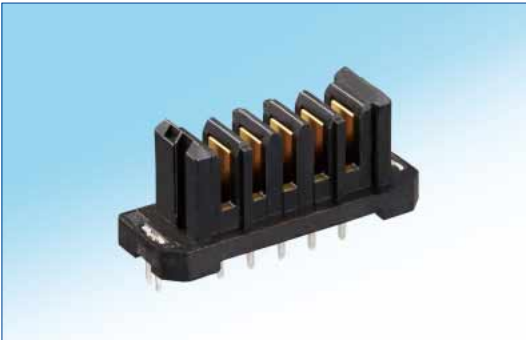

◆Diagram of recommended PCB layout dimensions

(Note) PCB thickness : t= 1.6mm

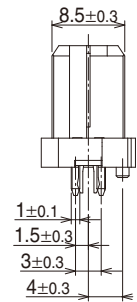
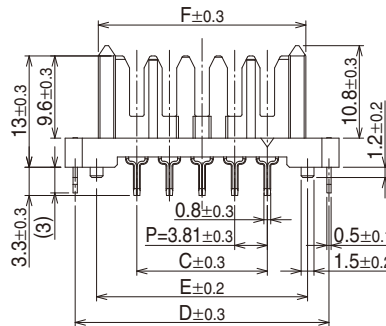
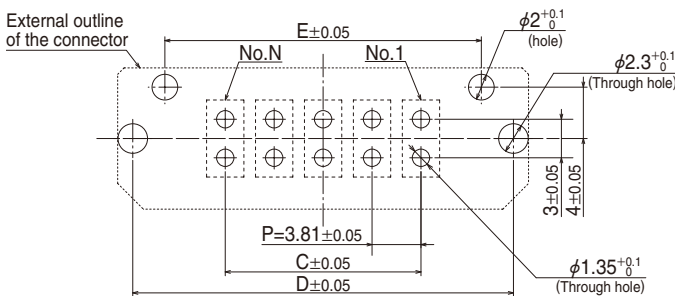

Unit : mm

Part No.	HRS No.	A	C	D	E	F	N (No. of Contacts)
FX30B-2P-3.81DSA20	570-3100-3 00	20.56	3.81	18.21	13.21	12.81	2
FX30B-3P-3.81DSA20	570-3101-6 00	24.37	7.62	22.02	17.02	16.62	3
FX30B-4P-3.81DSA20	570-3102-9 00	28.18	11.43	25.83	20.83	20.43	4
FX30B-5P-3.81DSA20	570-3103-1 00	31.99	15.24	29.64	24.64	24.24	5

●Straight header - 25 (P-DSA25 type)

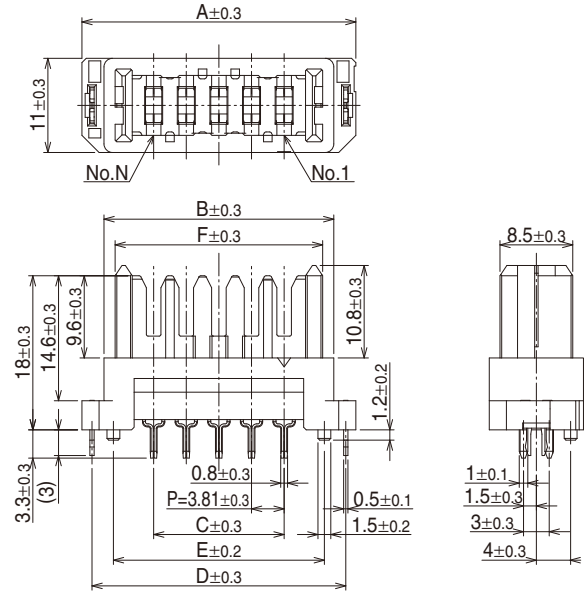
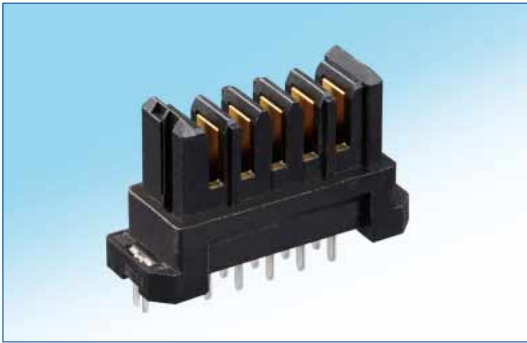

◆Diagram of recommended PCB layout dimensions  
(Note) PCB thickness : t = 1.6mm

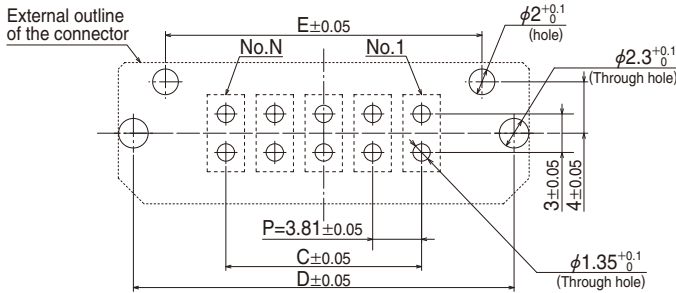

Unit : mm

Part No.	HRS No.	A	B	C	D	E	F	N (No. of Contacts)
FX30B-2P-3.81DSA25	570-3200-8 00	20.56	15.41	3.81	18.21	13.21	12.81	2
FX30B-3P-3.81DSA25	570-3201-0 00	24.37	19.22	7.62	22.02	17.02	16.62	3
FX30B-4P-3.81DSA25	570-3202-3 00	28.18	23.03	11.43	25.83	20.83	20.43	4
FX30B-5P-3.81DSA25	570-3203-6 00	31.99	26.84	15.24	29.64	24.64	24.24	5

●Straight header - 30 (P-DSA30 type)

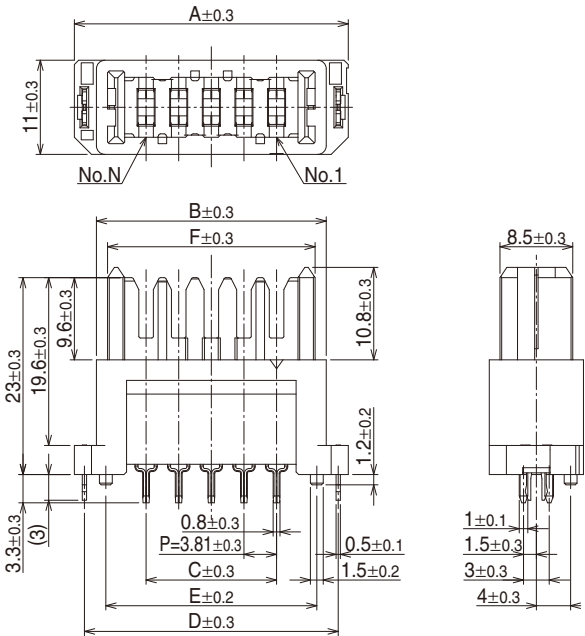

◆Diagram of recommended PCB layout dimensions  
(Note) PCB thickness : t = 1.6mm

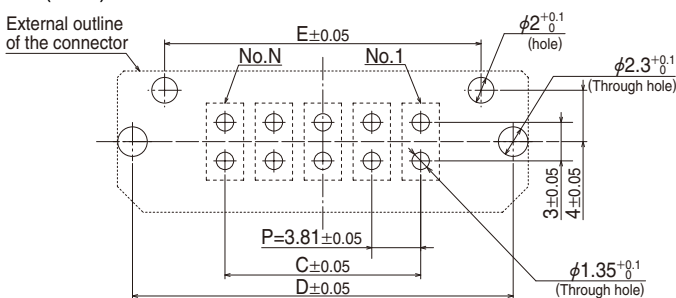

Unit : mm

Part No.	HRS No.	A	B	C	D	E	F	N (No. of Contacts)
FX30B-2P-3.81DSA30	570-3300-2 00	20.56	15.41	3.81	18.21	13.21	12.81	2
FX30B-3P-3.81DSA30	570-3301-5 00	24.37	19.22	7.62	22.02	17.02	16.62	3
FX30B-4P-3.81DSA30	570-3302-8 00	28.18	23.03	11.43	25.83	20.83	20.43	4
FX30B-5P-3.81DSA30	570-3303-0 00	31.99	26.84	15.24	29.64	24.64	24.24	5



●Right angle receptacle (S-DS type) One pin skipped type

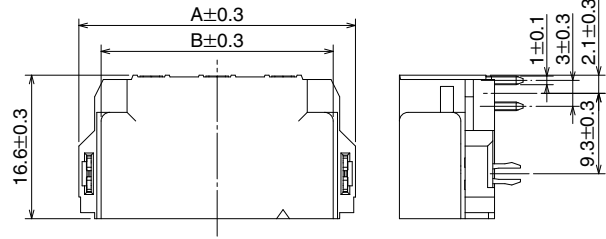

◆Diagram of recommended PCB layout dimensions

(Note) PCB thickness : t= 1.6mm

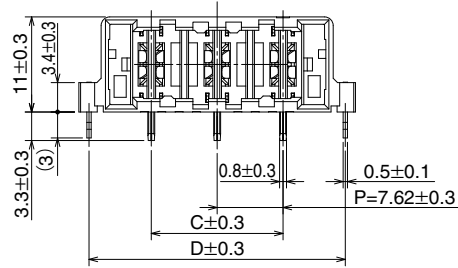
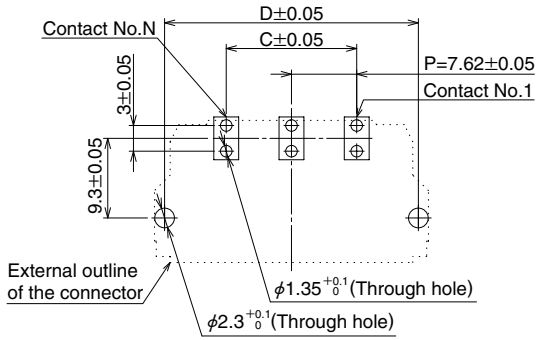

Unit : mm

Part No.	HRS No.	A	B	C	D	N (No. of Contacts)
FX30B-2S-7.62DS	570-3604-7 00	24.37	19.22	7.62	22.02	2
FX30B-3S-7.62DS	570-3605-0 00	31.99	26.84	15.24	29.64	3

●Straight receptacle (S-DSA type) One pin skipped type

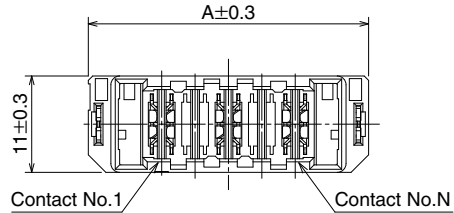

◆Diagram of recommended PCB layout dimensions

(Note) PCB thickness : t= 1.6mm

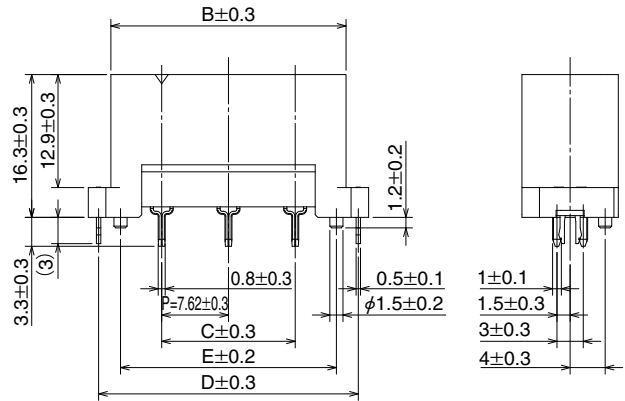
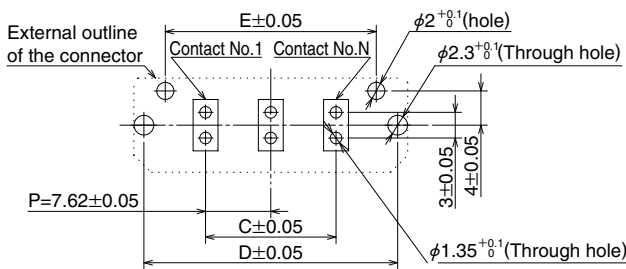

Unit : mm

Part No.	HRS No.	A	B	C	D	E	N (No. of Contacts)
FX30B-2S-7.62DSA	570-3504-2 00	24.37	19.22	7.62	22.02	17.02	2
FX30B-3S-7.62DSA	570-3505-5 00	31.99	26.84	15.24	29.64	24.64	3

●Right angle header (P-DS type) One pin skipped type

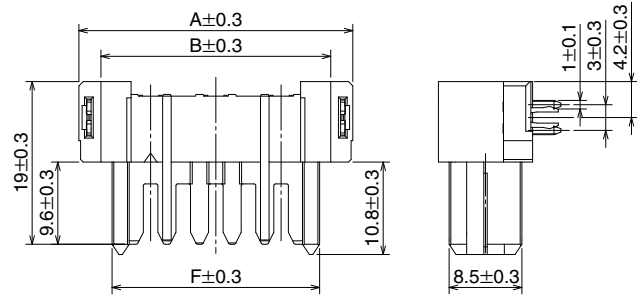

◆Diagram of recommended PCB layout dimensions  
(Note) PCB thickness : t= 1.6mm

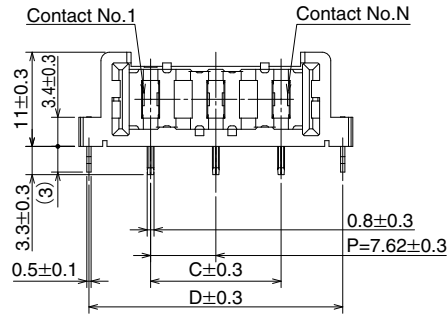
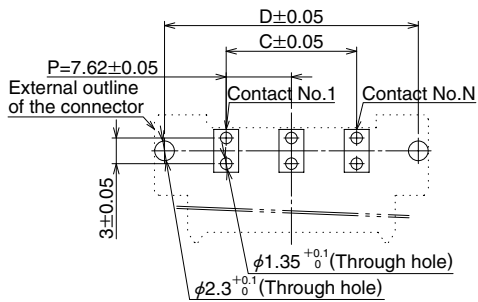

Unit : mm

Part No.	HRS No.	A	B	C	D	F	N (No. of Contacts)
FX30B-2P-7.62DS	570-3404-8 00	24.37	19.22	7.62	22.02	16.62	2
FX30B-3P-7.62DS	570-3405-0 00	31.99	26.84	15.24	29.64	24.24	3

●Straight header - 20 (P-DSA20 type) One pin skipped type

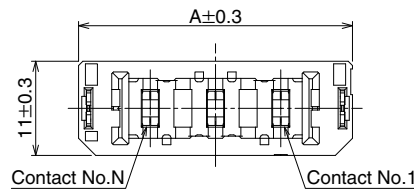

◆Diagram of recommended PCB layout dimensions  
(Note) PCB thickness : t= 1.6mm

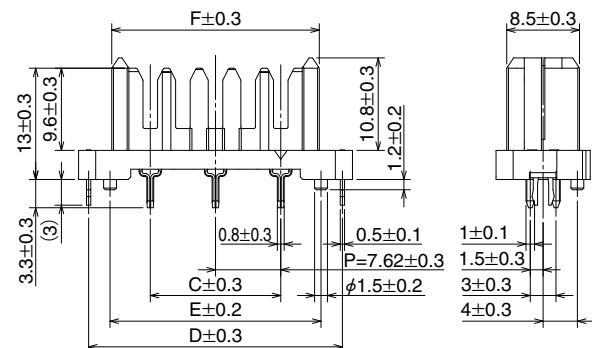
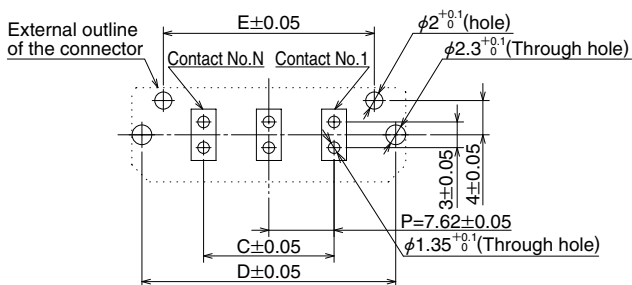

Unit : mm

Part No.	HRS No.	A	C	D	E	F	N (No. of Contacts)
FX30B-2P-7.62DSA20	570-3104-4 00	24.37	7.62	22.02	17.02	16.62	2
FX30B-3P-7.62DSA20	570-3105-7 00	31.99	15.24	29.64	24.64	24.24	3

●Straight header - 25 (P-DSA25 type) One pin skipped type

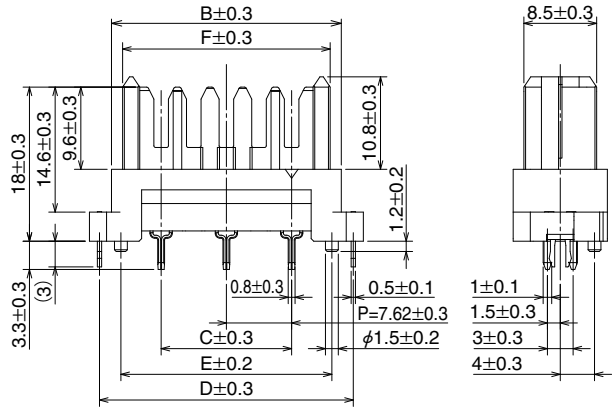
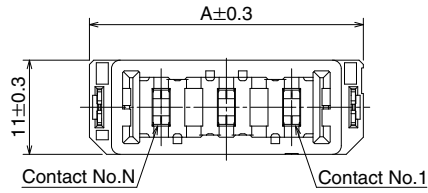

◆Diagram of recommended PCB layout dimensions

(Note) PCB thickness : t= 1.6mm

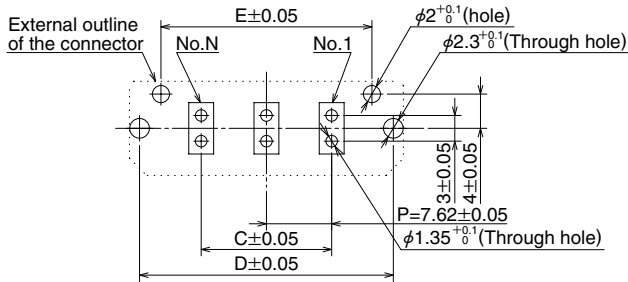

Unit : mm

Part No.	HRS No.	A	B	C	D	E	F	N (No. of Contacts)
FX30B-2P-7.62DSA25	570-3205-1 00	24.37	19.22	7.62	22.02	17.02	16.62	2
FX30B-3P-7.62DSA25	570-3206-4 00	31.99	26.84	15.24	29.64	24.64	24.24	3

●Straight header - 30 (P-DSA30 type) One pin skipped type

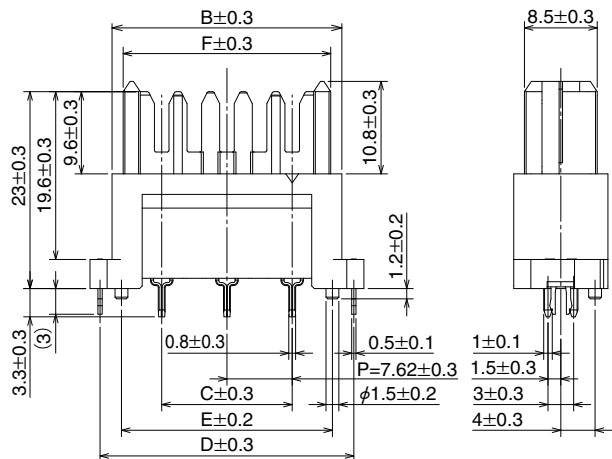
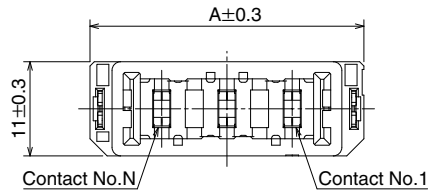

◆Diagram of recommended PCB layout dimensions

(Note) PCB thickness : t= 1.6mm

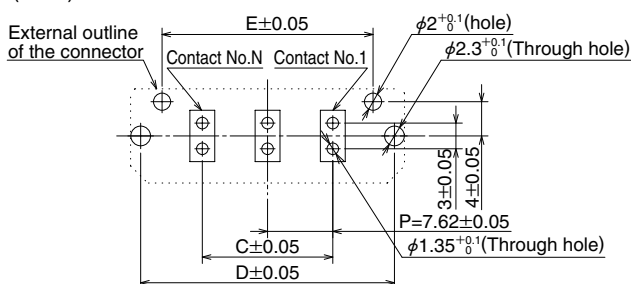

Unit : mm

Part No.	HRS No.	A	B	C	D	E	F	N (No. of Contacts)
FX30B-2P-7.62DSA30	570-3304-3 00	24.37	19.22	7.62	22.02	17.02	16.62	2
FX30B-3P-7.62DSA30	570-3205-6 00	31.99	26.84	15.24	29.64	24.64	24.24	3

## ◆Tray Packaging State Diagram

### ●Right angle receptacle (S-DS type)

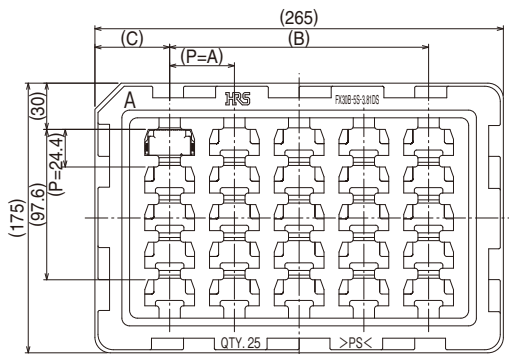

### ●Normal type Unit : mm

Part No.	A	B	C	Quantity
FX30B-2S-3.81DS	30	180	42.5	35
FX30B-3S-3.81DS	35.5	177.5	43.75	30
FX30B-4S-3.81DS				
FX30B-5S-3.81DS	42	168	48.5	25

### ●Straight receptacle (S-DSA type)

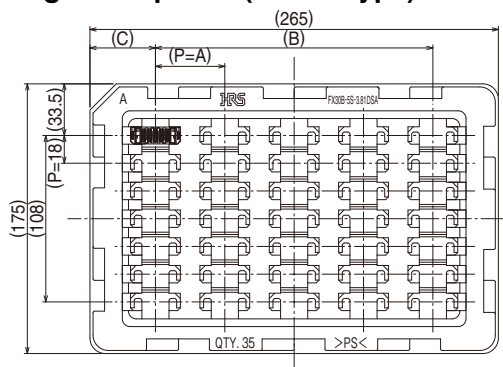

### ●One pin skipped type Unit : mm

Part No.	A	B	C	Quantity
FX30B-2S-7.62DS	35.5	177.5	43.75	30
FX30B-3S-7.62DS	42	168	48.5	25

### ●Normal type Unit : mm

Part No.	A	B	C	Quantity
FX30B-2S-3.81DSA	31.5	189	38	49
FX30B-3S-3.81DSA	38	190	37.5	42
FX30B-4S-3.81DSA	45	180	42.5	35
FX30B-5S-3.81DSA				

### ●One pin skipped type Unit : mm

Part No.	A	B	C	Quantity
FX30B-2S-7.62DSA	38	190	37.5	42
FX30B-3S-7.62DSA	45	180	42.5	35

### ●Right angle header (P-DS type)

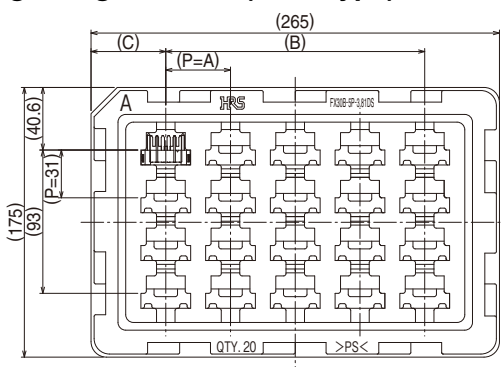

### ●Normal type Unit : mm

Part No.	A	B	C	Quantity
FX30B-2P-3.81DS	30	180	42.5	28
FX30B-3P-3.81DS	35.5	177.5	43.75	24
FX30B-4P-3.81DS				
FX30B-5P-3.81DS	42	168	48.5	20

### ●One pin skipped type Unit : mm

Part No.	A	B	C	Quantity
FX30B-2P-7.62DS	35.5	177.5	43.75	24
FX30B-3P-7.62DS	42	168	48.5	20

### ●Straight header - \*\* (P-DSA\*\* type)

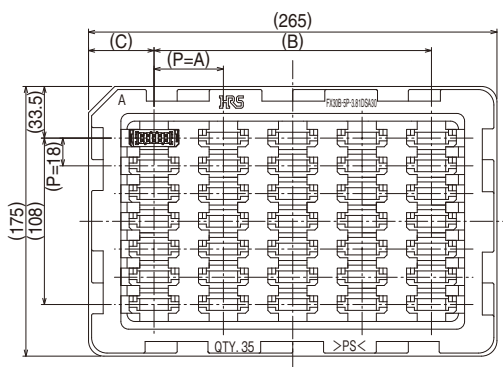

### ●Normal type Unit : mm

Part No.	A	B	C	Quantity
FX30B-2P-3.81DSA**	31.5	189	38	49
FX30B-3P-3.81DSA**	38	190	37.5	42
FX30B-4P-3.81DSA**	45	180	42.5	35
FX30B-5P-3.81DSA**				

### ●One pin skipped type Unit : mm

Part No.	A	B	C	Quantity
FX30B-2P-7.62DSA**	38	190	37.5	42
FX30B-3P-7.62DSA**	45	180	42.5	35

Note : The above illustration shows a tray form example. Please refer to “delivery specifications” for official individual forms.

## ◆Cleaning conditions

### ●Organic Solvent Cleaning

Solvent	Room temperature cleaning	Heated cleaning
IPA (Isopropyl alcohol)	○	○

### ●Water Cleaning

When using water cleaner (terpene, alkali saponifier, etc.), please select a cleaner according to the chart of effects to metal and resin issued by each cleaner manufacture. In addition, please make sure that the connectors are not left behind without removing moisture.

### ●Precautions for Cleaning

If flax or cleaner remains in the connector after it was cleaned using organic solvent or water cleaner, the performance of the connector may deteriorate. Make sure that the connectors are cleaned thoroughly.

## ◆Usage precautions

●A position misalignment absorption function is provided in this product. Please use this product within the dimensions shown in the below diagram, while taking into account the connector mounting position misalignments and PCB mating position misalignments.

●The purpose of the position misalignment absorption function provided on this product is to absorb the misalignments between the connector mounting positions and between the PCB mating positions. **This function cannot be used for the purpose to absorb mating position misalignments due to vibrations.** Please use the connectors after the PCBs have been fixed so that the connector positions are fixed securely. Avoid supporting PCBs by connectors only, and be sure to fix the PCBs using methods other than the connectors.

●This connector is designed to correct minor mating misalignments. This ability creates a structure that allows more for more movement and shifting between its pieces than with other similar connectors. The PCB boards need to be secured as well. If they are not, vibration or other external forces will cause the connectors to become unmated.

●This product has a structure to absorb position misalignments by the spring displacement of the contacts in pitch directions. Therefore, **a spring reaction force will be generated in the pitch directions when absorbing the position misalignments** (Approximately 4 N per 1 core) Please make sure that the structure bodies (positioning pins, screws, guiding rails, and other connectors, etc.) that will be used as the positioning base have enough strength against the spring reaction force.

### ●Allowable Mating Gap

The effective mating length of this product is 2mm.

Use the connectors so that the gap between the header and receptacle when they are mated is within 1.0 or 1.3mm.

Particularly make sure the gap does not exceed the limits due to warping of PCB, etc.

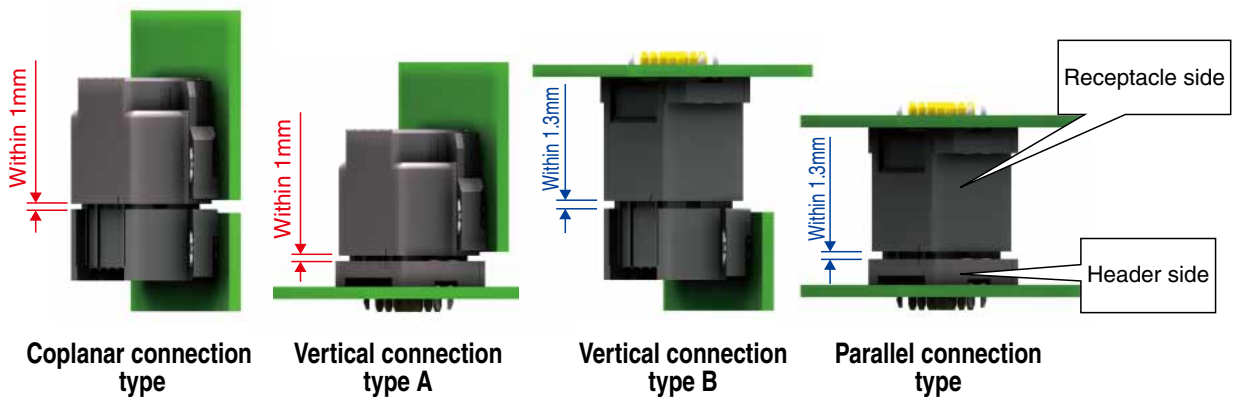
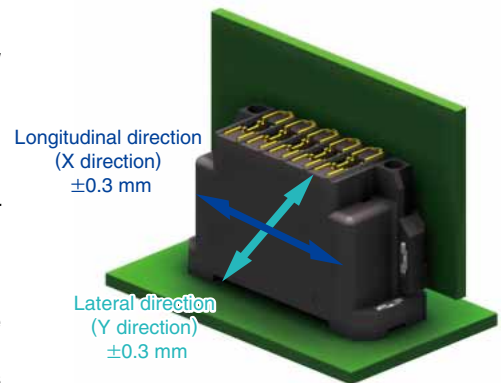

●A reverse insertion prevention structure and an abnormal mating position prevention structure have been provided in this connector, however, if the connectors are mated with an excessive force, connector breakage may result. Avoid improper mating of connectors by applying an excessive force and connect them correctly while confirming the connector polarities shown below. shown below. tors by applying an excessive force and connect them correctly while confirming the connector polarities shown below.

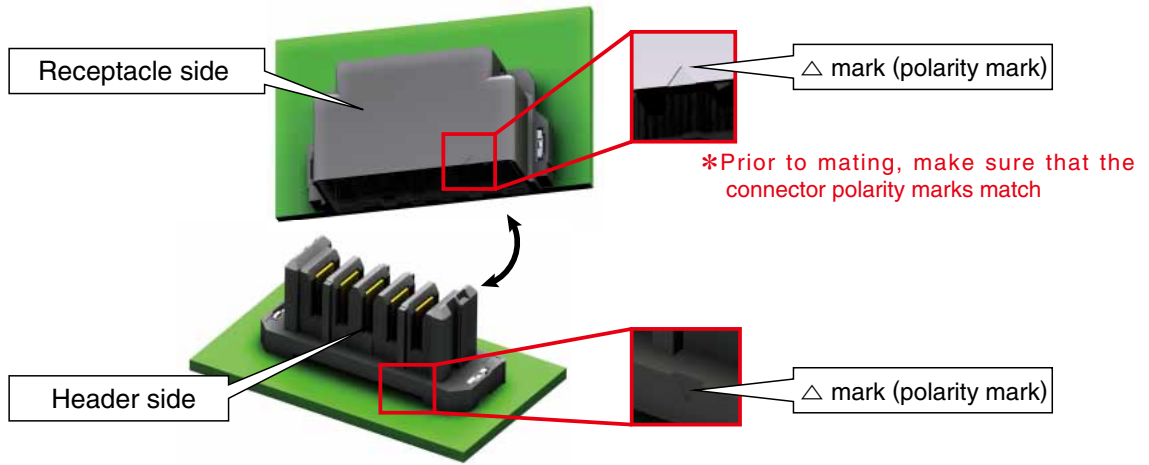

●A structure in which the contact deformation does not occur under normal mating operations has been provided on this connector, however, please make sure of the following; connector edge does not come to contact with the opening for mating, connectors are not mated diagonally in an abnormal manner, and foreign substances or hard objects, etc. do not touch the contacts. Pay attention so that contact deformation which causes a contact defect does not occur.



●If the connector is inserted/extracted forcibly in a wrong direction or it is rotated when inserting/extracting, a connector breakdown or contact defect may result. Please be careful.



●This product cannot be used for the purpose of current interruption application. (Prohibition of hot-swapping)

MEMO :

A series of horizontal dashed lines for taking notes.

**USA:**

**HIROSE ELECTRIC (U.S.A.), INC. HEADQUARTERS CHICAGO OFFICE**  
 2300 Warrenville Road, Suite 150,  
 Downers Grove, IL 60515  
 Phone : +1-630-282-6700  
<http://www.hirose.com/us/>

**USA:**

**HIROSE ELECTRIC (U.S.A.), INC. SAN JOSE OFFICE**  
 2841 Junction Ave, Suite 200  
 San Jose, CA. 95134  
 Phone : +1-408-253-9640  
 Fax : +1-408-253-9641  
<http://www.hirose.com/us/>

**USA:**

**HIROSE ELECTRIC (U.S.A.), INC. DETROIT OFFICE (AUTOMOTIVE)**  
 17197 N. Laurel Park Drive, Suite 253,  
 Livonia, MI 48152  
 Phone : +1-734-542-9963  
 Fax : +1-734-542-9964  
<http://www.hirose.com/us/>

**THE NETHERLANDS:**

**HIROSE ELECTRIC EUROPE B.V.**  
 Hogehillweg #8 1101 CC Amsterdam Z-O  
 Phone : +31-20-6557460  
 Fax : +31-20-6557469  
<http://www.hirose.com/eu/>

**GERMANY:**

**HIROSE ELECTRIC EUROPE B.V. GERMAN BRANCH**  
 Schoenbergstr. 20, 73760 ostfildern  
 Phone : +49-711-456002-1  
 Fax : +49-711-456002-299  
<http://www.hirose.com/eu/>

**GERMANY:**

**HIROSE ELECTRIC EUROPE B.V. NUREMBERG OFFICE**  
 Neumeyerstrasse 22-26, 90411 Nurnberg  
 Phone : +49-911 32 68 89 63  
 Fax : +49-911 32 68 89 69  
<http://www.hirose.com/eu/>

**GERMANY:**

**HIROSE ELECTRIC EUROPE B.V. HANOVER OFFICE**  
 Bayernstr. 3, Haus C 30855 Langenhagen, Germany  
 Phone : +49-511 97 82 61 30  
 Fax : +49-511 97 82 61 35  
<http://www.hirose.com/eu/>

**FRANCE:**

**HIROSE ELECTRIC EUROPE B.V. PARIS OFFICE**  
 Regus La Garenne Colombes, Place de La Belgique,  
 71 Boulevard National La Garenne Colombes, 92250, France  
 Phone : +33 (0) 1 7082 3170  
 Fax : +33 (1) 7082 3101  
<http://www.hirose.com/eu/>

**UNITED KINGDOM:**

**HIROSE ELECTRIC EUROPE BV (UK BRANCH)**  
 4 Newton Court, Kelvin Drive, Knowlhill,  
 Milton Keynes, MK5 8NH  
 Phone : +44-1908 202050  
 Fax : +44-1908 202058  
<http://www.hirose.com/eu/>

**CHINA:**

**HIROSE ELECTRIC (SHANGHAI) CO., LTD.**  
 1601, Henderson Metropolitan, NO.300, East Nanjing  
 Road, Huangpu District, Shanghai, China 200001  
 Phone : +86-21-6391-3355  
 Fax : +86-21-6391-3335  
<http://www.hirose.com/cn/>

**CHINA:**

**HIROSE ELECTRIC (SHANGHAI) CO.,LTD. BEIJING BRANCH**  
 A1001, Ocean International Center, Building 56# East 4th  
 Ring Middle Road, ChaoYang District, Beijing, 100025  
 Phone : +86-10-5165-9332  
 Fax : +86-10-5908-1381  
<http://www.hirose.com/cn/>

**CHINA:**

**HIROSE ELECTRIC TECHNOLOGIES (SHENZHEN) CO., LTD.**  
 Room 09-13, 19/F, Office Tower Shun Hing Square, Di Wang Commercial Centre,  
 5002 Shen Nan Dong Road, Shenzhen City, Guangdong Province, 518008  
 Phone : +86-755-8207-0851  
 Fax : +86-755-8207-0873  
<http://www.hirose.com/cn/>

**HONG KONG:**

**HIROSE ELECTRIC HONGKONG TRADING CO., LTD.**  
 Room 1001, West Wing, Tsim Sha Tsui Centre, 66  
 Mody Road, Tsim Sha Tsui East, Kowloon, Hong Kong  
 Phone : +852-2803-5338  
 Fax : +852-2591-6560  
<http://www.hirose.com/hk/>

**TAIWAN:**

**HIROSE ELECTRIC TAIWAN CO., LTD.**  
 103 8F, No.87, Zhengzhou Rd., Taipei  
 Phone : +886-2-2555-7377  
 Fax : +886-2-2555-7350  
<http://www.hirose.com/tw/>

**KOREA:**

**HIROSE KOREA CO.,LTD.**  
 250, Huimanggongwon-ro, Siheung-si,  
 Gyeonggi-do, Korea, 15083  
 Phone : +82-31-496-7000 or 7124  
 Fax : +82-31-496-7100  
<http://www.hirose.co.kr/>

**SINGAPORE:**

**HIROSE ELECTRIC SINGAPORE PTE. LTD.**  
 10 Anson Road #26-16, International Plaza  
 079903, Singapore  
 Phone : +65-6324-6113  
 Fax : +65-6324-6123  
<http://www.hirose.com/sg/>

**INDIA:**

**HIROSE ELECTRIC SINGAPORE PTE. LTD. DELHI LIAISON OFFICE**  
 Office NO.552, Regus-Green Boulevard, Level5, Tower C,  
 Sec62, Plot B-9A, Block B, Noida, 201301, Uttar Pradesh, India  
 Phone : +91-12-660-8018  
 Fax : +91-120-4804949  
<http://www.hirose.com/sg/>

**INDIA:**

**HIROSE ELECTRIC SINGAPORE PTE. LTD. BANGALORE LIAISON OFFICE**  
 Unit No-403, 4th Floor, No-84, Barton Centre, Mahatma  
 Gandhi (MG) Road, Bangalore 560 001, Karnataka, India  
 Phone : +91-80-4120 1907  
 Fax : +91-80-4120 9908  
<http://www.hirose.com/sg/>

**MALAYSIA:**

**PENANG REPRESENTATIVE OFFICE**  
 1-21-01, Suntech @ Penang Cybercity (1164), Lintang  
 Mayang Pasir 3,11950, Bayan Baru, Penang, Malaysia.  
 Phone : +604-619-2564  
 Fax : +604-619-2574  
<http://www.hirose.com/sg/>

**THAILAND:**

**BANGKOK OFFICE (REPRESENTATIVE OFFICE)**  
 Unit 4703, 47th FL., 1 Empire Tower, South Sathorn  
 Road, Yannawa, Sathorn, Bangkok 10120 Thailand  
 Phone : +66-2-686-1255  
 Fax : +66-2-686-3433  
<http://www.hirose.com/sg/>



**HIROSE ELECTRIC CO.,LTD.**

2-6-3,Nakagawa Chuoh,Tsuzuki-Ku,Yokohama-Shi 224-8540,JAPAN  
 TEL: +81-45-620-3526 Fax: +81-45-591-3726  
<http://www.hirose.com>  
<http://www.hirose-connectors.com>

Dec.1.2018 Copyright 2018 HIROSE ELECTRIC CO., LTD. All Rights Reserved.



# Mouser Electronics

Authorized Distributor

Click to View Pricing, Inventory, Delivery & Lifecycle Information:

## Hirose Electric:

[FX30B-2P-3.81DSA25](#) [FX30B-2S-3.81DS](#) [FX30B-5P-3.81DS](#) [FX30B-2P-3.81DS](#) [FX30B-4S-3.81DSA](#) [FX30B-5P-3.81DSA30](#) [FX30B-5P-3.81DSA20](#) [FX30B-4S-3.81DS](#) [FX30B-2P-3.81DSA20](#) [FX30B-3P-3.81DS](#) [FX30B-4P-3.81DSA25](#) [FX30B-4P-3.81DS](#) [FX30B-5S-3.81DS](#) [FX30B-5P-3.81DSA25](#) [FX30B-5S-3.81DSA](#) [FX30B-4P-3.81DSA20](#) [FX30B-2S-3.81DSA](#) [FX30B-3S-3.81DSA](#) [FX30B-4P-3.81DSA30](#) [FX30B-3P-3.81DSA30](#) [FX30B-3P-3.81DSA25](#) [FX30B-3P-3.81DSA20](#) [FX30B-3S-3.81DS](#) [FX30B-2P-3.81DSA30](#) [FX30B-3S-7.62DSA](#) [FX30B-3P-7.62DSA20](#) [FX30B-3S-7.62DS](#) [FX30B-2S-7.62DSA](#) [FX30B-2P-7.62DSA30](#) [FX30B-3P-7.62DSA25](#) [FX30B-2S-7.62DS](#) [FX30B-2P-7.62DS](#) [FX30B-2P-7.62DSA25](#) [FX30B-2P-7.62DSA20](#) [FX30B-3P-7.62DSA30](#) [FX30B-3P-7.62DS](#)