

LOC	DIST	REVISIONS					
E	B	P	LTR	DESCRIPTION	DATE	DWN	APVD
		A1		REVISED PER ECO-11-005150	28APR11	RK	HMR

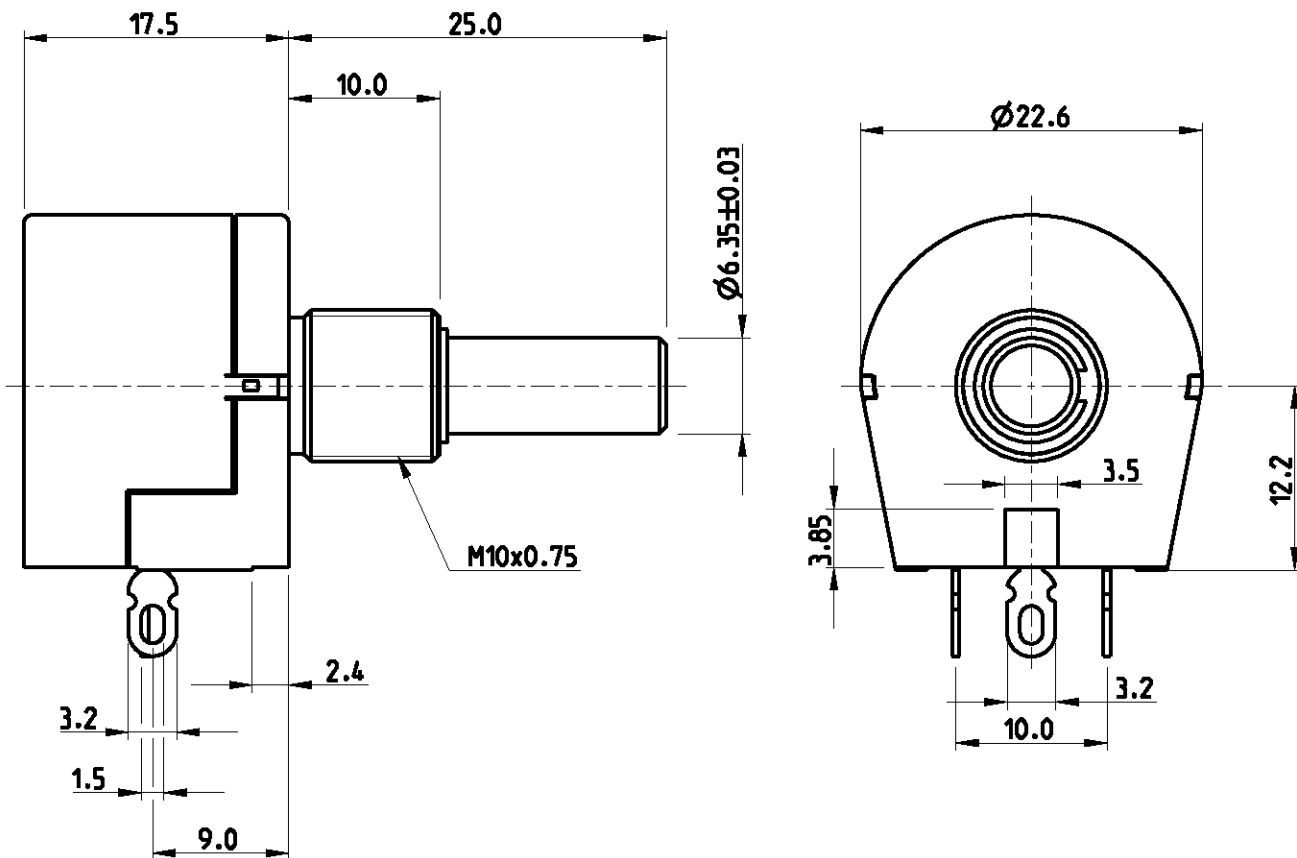

RoHS Compliant

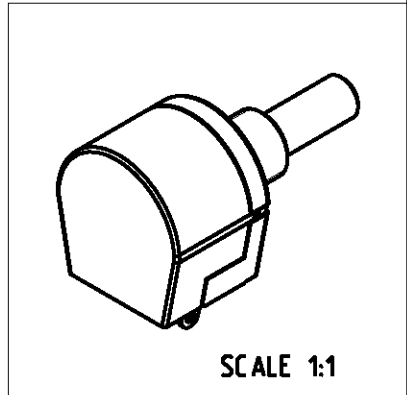

FOR FURTHER INFORMATION SEE DATA SHEET FOR SERIES TW - WIRE WOUND SPINDLE OPERATED POTENTIOMETER

2009 RELEASED FOR PUBLICATION ALL RIGHTS RESERVED. THIS DRAWING IS UNPUBLISHED. BY

DIMENSIONS:	DWN	08-JAN-09	MATERIAL	-	FINISH	-
mm	CHK	08-JAN-09				
TOLERANCES UNLESS OTHERWISE SPECIFIED:	APVD	08-JAN-09				
0 PLC ±0.2	STEPHEN.P		NAME WIRE WOUND SPINDLE OPERATED POTENTIOMETER			
1 PLC ±0.1	PRODUCT SPEC	-	SERIES TW			
2 PLC ±	APPLICATION SPEC	-	SIZE	CAGE CODE	DRAWING NO	RESTRICTED TO
3 PLC ±			A 4	00779	C-1676979	-
4 PLC ±	WEIGHT	-	CUSTOMER DRAWING			
ANGLES ±5°			SCALE	2:1	SHEET 1 OF 1	REV A1

Mouser Electronics

Authorized Distributor

Click to View Pricing, Inventory, Delivery & Lifecycle Information:

[TE Connectivity:](#)

[TW1103KA](#)