



Features

- RoHS lead-free-solder and lead-solder-exempted products are available.
- Extremely wide input voltage ranges up to 150 VDC
- 4 outputs up to 60 V
- 1500 to 1800 VAC i/o electric strength test
- Electrical isolation between outputs
- Programmable input undervoltage lockout
- Shutdown/inhibit input
- Adjustable output voltages with flexible load distribution
- Frequency synchronization
- Outputs no-load, overload, and short-circuit proof
- Operating ambient temperature from -40 to 85 °C
- Thermal protection
- Low profile: 10.5 mm or 8.9 mm with open frame
- Basic insulation
- Flexible output possibilities between 5 V and 60 V

Safety-approved to IEC/EN 60950-1 and UL/CSA 60950-1 2nd Ed.



Description

The IMX35 Series of board-mountable, 35 Watt DC-DC converters has been designed according to the latest industry requirements and standards. The converters are particularly suitable for use in mobile or stationary applications in transport, railways, industry, or telecommunication, where variable input voltages or high transient voltages are prevalent.

Covering a total input voltage range from 9 V up to 150 V with 4 different models, the converters are available with up to four electrically isolated outputs from 5 V to 60 V, externally adjustable and with flexible load distribution. A shutdown input allows remote converter on/off. Features include consistently high efficiency over the entire input voltage range, high reliability, and excellent dynamic response to load and line changes.

The converters are designed and built according to the international safety standards IEC/EN/UL 60950, and

approved by CSA. The converters provide basic insulation.

The circuit is comprised of 2 planar magnetics devices, and all components are automatically assembled and securely soldered onto a single PCB without any wire connection. Magnetic feedback ensures maximum reliability and repeatability in the control loop over all operating conditions. Careful considerations of possible thermal stresses ensure the absence of hot spots providing long life in environments, where temperature cycles are present. The thermal design without using any potting material allows operation at full load up to an ambient temperature of 71 °C in free air and operation up to 105 °C with airflow. For extremely high vibration environments the case has holes for screw mounting.

Table of Contents

	Page		Page
Description	1	Electromagnetic Compatibility (EMC)	11
Model Selection	2	Immunity to Environmental Conditions	12
Functional Description	3	Mechanical Data	13
Electrical Input Data	4	Safety and Installation Instructions	14
Electrical Output Data	6	Options	15
Auxiliary Functions	9		

Copyright © 2015, Bel Power Solutions Inc. All rights reserved.

Model Selection

Table 1: Model Selection

Output 1		Output 2		Output 3		Output 4		Input voltage	Efficiency ¹	Model	Opt.	
$V_{O\ nom}$ [V]	$I_{O\ nom}$ [A]	$V_{O\ nom}$ [V]	$I_{O\ nom}$ [A]	$V_{O\ nom}$ [V]	$I_{O\ nom}$ [A]	$V_{O\ nom}$ [V]	$I_{O\ nom}$ [A]	$V_{i\ min}$ to $V_{i\ max}$ [V]	η_{min} [%]	η_{typ} [%]		
5	1.35	5	1.35	5	1.35	5	1.35	9 to 36	82.5	86	20IMX35D05D05-8	i
5	1.4	5	1.4	5	1.4	5	1.4	18 to 75	82	87	40IMX35D05D05-8	Z
5	1.4	5	1.4	5	1.4	5	1.4	40 to 121	83	86	70IMX35D05D05-8	G
5	1.4	5	1.4	5	1.4	5	1.4	60 to 150 ²	82	86	110IMX35D05D05-8	
12	0.65	12	0.65	12	0.65	12	0.65	9 to 36	83.7	86	20IMX35D12D12-8	
12	0.7	12	0.7	12	0.7	12	0.7	18 to 75	83.7	88	40IMX35D12D12-8	
12	0.7	12	0.7	12	0.7	12	0.7	40 to 121	84.5	88	70IMX35D12D12-8	
12	0.7	12	0.7	12	0.7	12	0.7	60 to 150 ²	84	88	110IMX35D12D12-8	
15	0.55	15	0.55	15	0.55	15	0.55	9 to 36	85	88	20IMX35D15D15-8	
15	0.6	15	0.6	15	0.6	15	0.6	18 to 75	83.6	89	40IMX35D15D15-8	
15	0.6	15	0.6	15	0.6	15	0.6	40 to 121	84	88	70IMX35D15D15-8	
15	0.6	15	0.6	15	0.6	15	0.6	60 to 150 ²	83	88	110IMX35D15D15-8	
5	1.35	12	0.65	12	0.65	5	1.35	9 to 36	84	88	20IMX35D05D12-8	
5	1.4	12	0.7	12	0.7	5	1.4	18 to 75	84	89	40IMX35D05D12-8	
5	1.4	12	0.7	12	0.7	5	1.4	40 to 121	84	88	70IMX35D05D12-8	
5	1.4	12	0.7	12	0.7	5	1.4	60 to 150 ²	83.6	88	110IMX35D05D12-8	
5	1.35	15	0.55	15	0.55	5	1.35	9 to 36	84	86	20IMX35D05D15-8	
5	1.4	15	0.6	15	0.6	5	1.4	18 to 75	83.5	89	40IMX35D05D15-8	
5	1.4	15	0.6	15	0.6	5	1.4	40 to 121	84	88	70IMX35D05D15-8	
5	1.4	15	0.6	15	0.6	5	1.4	60 to 150 ²	84	88	110IMX35D05D15-8	

¹ Efficiency at $T_A = 25\ ^\circ\text{C}$, $V_{O\ nom}$, $I_{O\ nom}$

² 154 V for 2 s.

Part Number Description

Input voltage range V_i

9 to 36 VDC	20
18 to 75 VDC	40
40 to 121 VDC	70
60 to 150 VDC	110

Series IMX35

Outputs 1 and 4 (1st power train) D05, D12, D15

Outputs 2 and 3 (2nd power train) D05, D12, D15

Operating ambient temperature range

$T_A = -40$ to $85\ ^\circ\text{C}$ -8

Options: Inhibit -i

Open frame Z

RoHS compliant for all six substances **G**

40 IMX35 D05 D05 -8 i Z G



Note: The sequence of options must follow the order above!

G Preferred for new designs

Product Marking

Converters without option Z are marked with type designation, input and output voltages and currents, applicable safety approval and recognition marks, company logo, production date, and serial no.

Functional Description

The IMX35 converters are comprised of 2 feedback-controlled interleaved-switching flyback powertrains using current mode PWM (pulse width modulation).

Each converter consists of 4 electrically isolated outputs deriving from 2 power trains. Vo1, Vo4 derive from the first powertrain and Vo2, Vo3 from the second one. Thus each pair of outputs is independent from the other one.

Voltage regulation for each pair of outputs is achieved with passive transformer feedback from the main transformer of the powertrain. Each pair of outputs has the same output voltage (i.e. D05, D12, etc.). If both powertrains have the same output

voltage (e.g. D12D12), all outputs may be simultaneously adjusted by the Trim input (pin 5). In case of different output voltages (e.g. D05D15), the Trim1 input influences only Vo1 and Vo4.

Current limitation is provided by the primary circuit for each powertrain and limits the possible output power for each pair of outputs. In the case of an overload on either of the power trains, which causes the output voltage to fall less than typically 60% of $V_{o\ nom}$, the entire converter will shut down and automatically restart in short intervals (hiccup mode).

The incorporated overtemperature protection shuts down the converter in excessive overtemperature conditions with automatic restart.



Fig. 1
Block diagram of quad-output models

Electrical Input Data

General conditions:

$T_A = 25\text{ }^\circ\text{C}$, unless specified

Pins 8 (shutdown or i), 6 (W), 5 (Trim or Trim1), and 1 (PUL) left open-circuit (not connected), unless specified.

Table 2: Input Data

Input			20IMX35			40IMX35			Unit
Characteristics		Conditions	min	typ	max	min	typ	max	
V_i	Input voltage range ¹	$T_{A\text{ min}}$ to $T_{A\text{ max}}$	9 ²		36	18 ²		75	VDC
$V_{i\text{ nom}}$	Nominal input voltage	$I_o = 0$ to $I_{o\text{ nom}}$	20			40			
$V_{i\text{ sur}}$	Repetitive surge voltage	Abs. max input (3 s)	40			100			
$t_{\text{start-up}}$	Converter start-up time ²	Switch on	0.25			0.25			s
		SD high	0.1			0.1			
t_{rise}	Rise time ³	$V_{i\text{ nom}}$ resist load	3			3			ms
		$I_{o\text{ nom}}$ capac. load	6	12		6	12		
$I_{i\text{ o}}$	No load input current	$I_o = 0$, $V_{i\text{ min}}$ to $V_{i\text{ max}}$	70			50			mA
I_{irr}	Reflected ripple current	$I_o = 0$ to $I_{o\text{ nom}}$	30			30			mA _{pp}
$I_{\text{inr p}}$	Inrush peak current ⁴	$V_i = V_{i\text{ nom}}$	8			9			A
C_i	Input capacitance	for surge calculation	2			1.3			μF
V_{SD}	Shut down voltage	Converter disabled	-10 to 0.7			-10 to 0.7			V
		Converter operating	open circuit or 2 to 20			open circuit or 2 to 20			
R_{SD}	Shutdown input resistance		approx. 10			approx. 10			kΩ
I_{SD}	Input current during shutdown	$V_{i\text{ min}}$ to $V_{i\text{ max}}$	12			6			mA
f_s	Switching frequency	$V_{i\text{ min}}$ to $V_{i\text{ max}}$, $I_o = 0$ to $I_{o\text{ nom}}$	220	240		220	240		kHz

Input			70IMX35			110IMX35			Unit
Characteristics		Conditions	min	typ	max	min	typ	max	
V_i	Input voltage range ¹	$T_{A\text{ min}}$ to $T_{A\text{ max}}$	40 ²		121	60 ²		150 ⁵	VDC
$V_{i\text{ nom}}$	Nominal input voltage	$I_o = 0$ to $I_{o\text{ nom}}$	70			110			
$V_{i\text{ sur}}$	Repetitive surge voltage	Abs. max input (3 s)	150			170			
$t_{\text{start-up}}$	Converter start-up time ²	Switch on	0.25			0.4			s
		SD high	0.1			0.1			
t_{rise}	Rise time ³	$V_{i\text{ nom}}$ resist load	3			3			ms
		$I_{o\text{ nom}}$ capac. load	6	12		6	12		
$I_{i\text{ o}}$	No load input current	$I_o = 0$, $V_{i\text{ min}}$ to $V_{i\text{ max}}$	30			20			mA
I_{irr}	Reflected ripple current	$I_o = 0$ to $I_{o\text{ nom}}$	30			30			mA _{pp}
$I_{\text{inr p}}$	Inrush peak current ⁴	$V_i = V_{i\text{ nom}}$	7			7			A
C_i	Input capacitance	for surge calculation	0.5			0.5			μF
V_{SD}	Shut down voltage	Converter disabled	-10 to 0.7			-10 to 0.7			V
		Converter operating	open circuit or 2 to 20			open circuit or 2 to 20			
R_{SD}	Shutdown input resistance		approx. 10			approx. 10			kΩ
I_{SD}	Input current during shutdown	$V_{i\text{ min}}$ to $V_{i\text{ max}}$	5			5			mA
f_s	Switching frequency	$V_{i\text{ min}}$ to $V_{i\text{ max}}$, $I_o = 0$ to $I_{o\text{ nom}}$	220	240		225 ⁶			kHz

¹ $V_{i\text{ min}}$ will not be as stated, if V_o is increased above $V_{o\text{ nom}}$ by use of Trim input. If the output voltage is set to a higher value, $V_{i\text{ min}}$ will be proportionately increased.

² Input undervoltage lockout at typ. 85% of $V_{i\text{ min}}$.

³ Measured with resistive and max. admissible capacitive load.

⁴ Source impedance according to ETS 300132-2, version 4.3.

⁵ 154 V during 2 s

⁶ Revision BA or later. Older converters had $f_s \leq 240$ kHz.

Inrush Current

The inrush current has been kept as low as possible by choosing a very small input capacitance. A series resistor may be installed in the input line in order to further reduce this current.



Fig. 2
 Typical inrush current at $V_{i, nom}$, $P_{o, nom}$ versus time (40IMX35).
 Source impedance according to ETS 300132-2 at $V_{i, nom}$.



Fig. 3
 Converter start-up and rise time (see table 2)

Reverse Polarity Protection

The built-in suppressor diode also provides for reverse polarity protection at the input by conducting current in the reverse direction. An external fuse is required to limit this current.

Table 3: Recommended external fuses in the non-earthed input line

Converter model	Fuse type
20IMX35	F8.0A
40IMX35	F4.0A
70IMX35	F2.0A
110IMX35	F1.5A

Input Transient Voltage Protection

A built-in suppressor diode provides effective protection against input transients, which may be generated for example by short-circuits across the input lines, where the network inductance may cause high energy pulses.

Table 4: Built-in transient voltage suppressor

Model	Breakdown voltage $V_{Br, nom}$ [V]	Peak power at 1 ms P_p [W]	Peak pulse current I_{pp} [A]
20IMX35	39	1500	22
40IMX35	100	1500	9.7
70IMX35	151	600	2.9
110IMX35	176	600	2.5

For very high energy transients as for example to achieve IEC/EN 61000-4-5 compliance (as per table *Electromagnetic Immunity*) an external inductor and capacitor are required. The components should have similar characteristics as listed in table below.

Table 5: Components for external circuitry for IEC/EN 61000-4-5, level 2

Model	Inductor (L)	Capacitor (C)	Diode (D)
20IMX35	22 μ H / 5 A	470 μ F / 40 V	1.5 k E47A
40IMX35	68 μ H / 2.7 A	2 x 100 μ F / 100 V	-
70IMX35	100 μ H / 1 A	2 x 82 μ F / 200 V	-
110IMX35	150 μ H / 0.8 A	2 x 82 μ F / 200 V	-



Fig. 4

Example for external circuitry to comply with IEC/EN 61000-4-5; the diode D is only necessary for 20IMX35 models.

Electrical Output Data

General conditions:

- $T_A = 25\text{ °C}$, unless T_C is specified
- Pins 8 (shutdown or i), 6 (W), 5 (Trim or Trim1), and 1 (PUL) left open-circuit (not connected), unless specified.

Table 6: Output data *per double-output powertrain* (V_{o1}/V_{o4} or V_{o2}/V_{o3} ; each power train has 2 outputs)

Output			2 x 5 V			2 x 12 V			2 x 15 V			Unit
Characteristics		Conditions	min	typ	max	min	typ	max	min	typ	max	
V_{o1} V_{o2}	Output voltage	$V_{i\text{ nom}}$ $I_o = 0.5 I_{o\text{ nom}}$	4.95		5.05	11.88		12.12	14.85		15.15	VDC
$I_{o\text{ nom}}$	Output current	$V_{i\text{ min}}$ to $V_{i\text{ max}}$	20IMX		2 x 1.35	2 x 0.65		2 x 0.55		A		
			40IMX		2 x 1.4	2 x 0.70		2 x 0.60				
			70IMX		2 x 1.4	2 x 0.70		2 x 0.60				
			110IMX		2 x 1.4	2 x 0.70		2 x 0.60				
I_{oL}	Current limit ¹	$V_{i\text{ nom}}, T_C = 25\text{ °C}$ $V_o = 93\% V_{o\text{ nom}}$	20IMX		3.5	1.8		1.5				
			40IMX		3.8	2.0		1.7				
			70IMX		3.8	2.0		1.7				
			110IMX		3.8	2.0		1.7				
ΔV_o	Line regulation	$V_{i\text{ min}}$ to $V_{i\text{ max}}, I_{o\text{ nom}}$			±1	±1		±1		%		
ΔV_{o1}	Load regulation	$V_{i\text{ nom}}$ $I_o = (0.1 \text{ to } 1) I_{o\text{ nom}}$			±3	±3		±3				
$V_{o1/2}$	Output voltage noise ⁵	$V_{i\text{ min}}$ to $V_{i\text{ max}}$ $I_o = I_{o\text{ nom}}$	2		80	120		150		mV _{pp}		
			3		40	60		70				
V_{oL}	Output overvoltage limit ⁴	Min. load 1%	115	130	115	130	115	130	%			
$C_{o\text{ ext}}$	Admissible capacitive load per power train ⁶	produced after 2011	0	6000	0	680	0	470	μF			
		produced until 2011	0	4000	0	470	0	330				
$V_{o\text{ d}}$	Dynamic load regulation	Voltage deviat.	$V_{i\text{ nom}}$		±250		±480		±520		mV	
t_d		Recovery time	$I_{o\text{ nom}} \leftrightarrow 1/2 I_{o\text{ nom}}$		0.75		0.75		0.75		ms	
α_{V_o}	Temperature coefficient $\Delta V_o/\Delta T_C$	$V_{i\text{ min}}$ to $V_{i\text{ max}}$ $I_o = (0.1 \text{ to } 1) I_{o\text{ nom}}$			±0.02		±0.02		±0.02		%/K	

¹ Both outputs of each powertrain connected in parallel. The current limit is primary side controlled. In the event of a sustained overload condition, the thermal protection may cause the converter to shut down (restart on cool-down).

² BW = 20 MHz, measured with an external capacitor of 1 μF across the output pins.

³ Measured with a probe according to EN 61204

⁴ The overvoltage protection is via a primary side second regulation loop, not tracking with Trim control.

⁵ Both outputs of each powertrain connected in parallel.

⁶ Sum of capacities on the outputs of each control powertrain.

Thermal Considerations

If a converter, mounted on a PCB, is located in free, quasi-stationary air (convection cooling) at the indicated maximum ambient temperature $T_{A \max}$ (see table *Temperature specifications*) and is operated at its nominal input voltage and output power, the case temperature T_C (T_{CZ} with option Z) measured at the measuring point of case temperature (see *Mechanical Data*) will approach the indicated value $T_{C \max}$ after the warm-up phase. However, the relationship between T_A and T_C depends heavily on the conditions of operation and integration into a system. The thermal conditions are influenced by input voltage, output current, airflow, temperature of surrounding components and the surfaces and properties of the printed circuit board. $T_{A \max}$ is therefore only an indicative value, and under practical operating conditions, the ambient temperature T_A may be higher or lower than this value.

Caution: The case temperature T_C (or T_{CZ}) measured at the measuring point of case temperature (see *Mechanical Data*) may under no circumstances exceed the specified maximum value. The installer must ensure that under all operating conditions T_C (or T_{CZ}) remains within the limits stated in the table *Temperature specifications*.

The converters provide the specified output power with free air convection cooling. In the upper temperature range the output power derating below should be observed.



Fig. 5
 Maximum allowed output power versus ambient temperature (models without option Z)

Overtemperature Protection

The converter is protected against possible overheating by means of an internal temperature monitoring circuit. It shuts down the converter above the internal temperature limit and attempts to automatically restart. This feature prevents excessive internal temperature building up which could occur under heavy overload conditions.

Short Circuit Behavior

The current limit characteristic shuts down the converter whenever a short circuit is applied to an output. It acts self-protecting and automatically recovers after removal of the overload condition (hiccup mode).

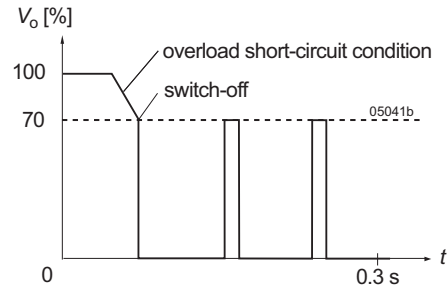

Fig. 6
 Overload switch off (hiccup mode), typical values.

Series and Parallel Connection

The outputs of one or several double-output powertrains may be connected in series respecting the current limitation.

Both outputs of the same powertrain can always be connected in parallel in will behave like a single output.

Several outputs of the same converter with equal output voltage (e.g. 5 V / 5 V) can be connected in parallel and will share their output currents almost equally.

If outputs of the same converter are being parallel and series-connected, it is recommended that outputs from the same powertrains are parallel-connected first. This applies for instance, if 24 V shall be generated by a converter with four 12 V outputs; see fig. 7.

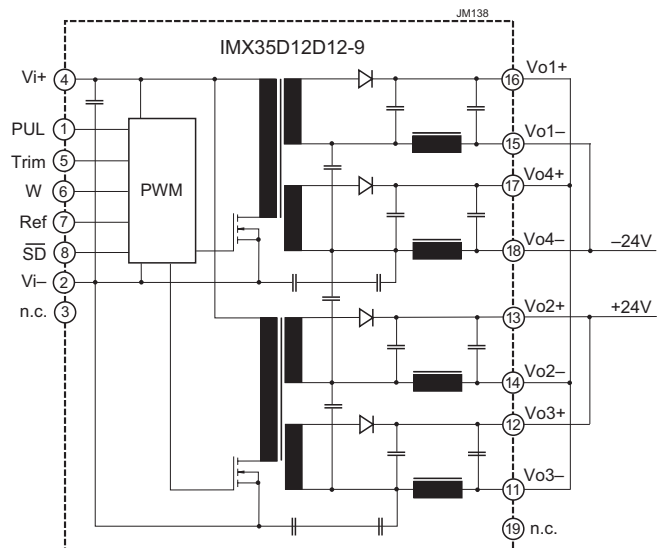

Fig. 7
 Generating 24 V with an IMX35D12D12-9

Note: Parallel operation of several converters may cause start-up problems. This becomes noticeable in applications, where one converter is not able to deliver alone the full resistive and capacitive load current, as it is required in true redundant systems.

Typical Performance Curves

General conditions:

- $T_A = 25^\circ\text{C}$, unless T_C is specified.
- Shut down and Trim pin left open-circuit.

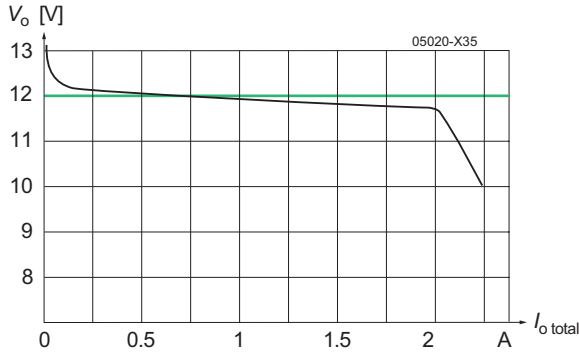

Fig. 8

V_o versus I_o (typ.) of double-output power trains, with both outputs in parallel (e.g., $V_{o1/4}$ of a 40IMX35D12D12)

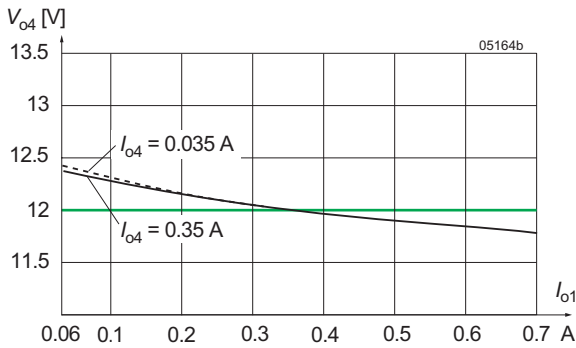

Fig. 9

Cross load regulation (typ.) on powertrain 1. V_{o4} versus I_{o1}

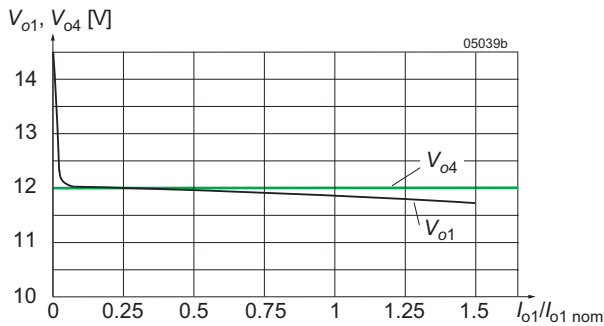

Fig. 10

Flexible load distribution (typ.) on power train 1 of a 40IMX35D12D12-8:

V_{o1} versus I_{o1} , $I_{o4} = 0.5 I_{o4 \text{ nom}}$

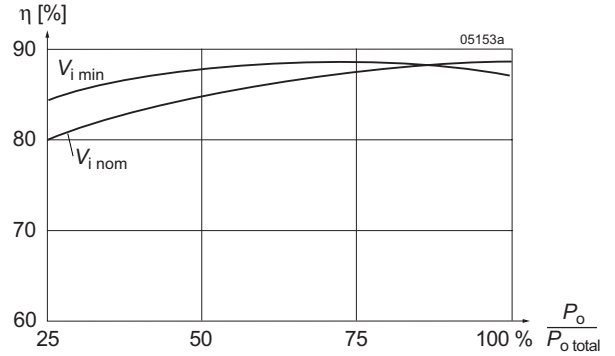

Fig. 11

Efficiency versus input voltage and load. Typical values (20IMX35D12D12-8)



Fig. 12

Efficiency versus input voltage and load. Typical values (40IMX35D12D12-8)

Auxiliary Functions

Adjustable Output Voltage

As a standard feature, the IMX35 offer adjustable output voltages in the range of 85 to 105% of $V_{o\text{ nom}}$. Fig. 12 shows the schematic diagram for the adjustment of quad-output models.

All models with equal output voltages have a Trim input at pin 5 referenced to the primary side, influencing all outputs simultaneously. Models with different output voltages exhibit a Trim1 input, influencing only the first power train (V_{o1} and V_{o4}).

Adjustment by means of an external resistor R_{ext} :

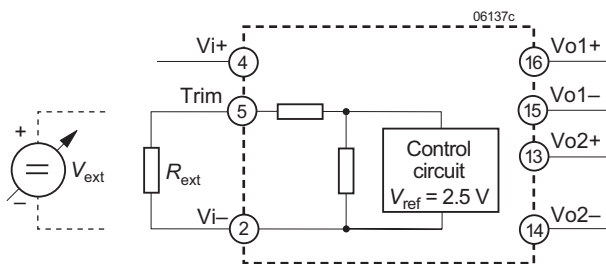

Fig. 13

Output voltage control by means of the Trim input

Adjustment of the output voltage by means of an external resistor R_{ext} is possible within the range of 100 to 105% of $V_{o\text{ nom}}$. R_{ext} should be connected between Trim (pin 5) and V_{i-} (pin 2). The following table indicates suitable resistor values for typical output voltages under nominal conditions ($V_{i\text{ nom}}$, $I_o = 0.5 I_{o\text{ nom}}$).

Note: Connection of R_{ext} to V_{i+} may damage the converter.

Table 7: R_{ext} for $V_o > V_{o\text{ nom}}$; approximate values ($V_{i\text{ nom}}$, $I_o = 0.5 I_{o\text{ nom}}$)

V_o [% $V_{o\text{ nom}}$]	R_{ext} [k Ω]	
	Trim	Trim1
105 to 108 (107 typically)	0	0
105	10	17
102	62	110
100	∞	∞

Adjustment by means of an external voltage source V_{ext}

For external output voltage adjustment in the range 85 to 105% of $V_{o\text{ nom}}$ a voltage source V_{ext} (0 to 20 V) is required, connected to Trim or Trim1 (pin 5) and V_{i-} . The table below indicates typical values V_o versus V_{ext} . Applying a control voltage of 15 to 20 V will set the converter into the hiccup mode. Direct paralleling of the Trim pins of converters of the same type connected in parallel is feasible.

Table 8: V_o versus V_{ext} for $V_o = 85$ to 105% $V_{o\text{ nom}}$; typical values ($V_{i\text{ nom}}$, $I_o = 0.5 I_{o\text{ nom}}$)

V_o [% $V_{o\text{ nom}}$]	V_{ext} [V]	
	Trim [V]	Trim1 [V]
>105	0	0
102	1.8	1.5
100	2.5	2.5
95	4.3	4.25
90	6.2	6.2
85	8	8

Synchronization (W)

It is possible to synchronize the switching frequency of one or more converters to an external clock signal.

This logic input W can be used to synchronize the oscillator to an external frequency source. This signal is edge-triggered with TTL thresholds and requires a source frequency of 490 to 540 kHz (duty cycle 10 to 90%). The external source frequency is internally divided by 2 to define the switching frequency of the converter. If unused, this pin can be connected to V_{i-} (pin 2) or left open-circuit.

Reference Output (Ref)

The converter provides a stable 5 V (± 0.1 V) reference signal on pin 7 (Ref). The output is protected by a 1 k Ω resistor. The signal may be used also in conjunction with the Trim input (pin 5) as a limited external voltage reference.

It is recommended to connect a filter capacitor (0.1 μF) between Ref and V_{i-} , if Ref is used.

Shutdown

The outputs of the converters may be enabled or disabled by means of a logic signal (TTL, CMOS, etc.) applied to shutdown (pin 8). If the shutdown function is not required, pin 8 should be left open-circuit:

Converter operating:	2.0 to 20 V
Converter disabled:	-10 to 0.7 V

Progr. Input Undervoltage Lockout PUL

A special feature of the converters (with Rev. BA or later) is the adjustable undervoltage lockout protection, which protects the converter (and the system) from high current caused by operation at low input voltages. This ensures easier start-up in distributed power systems.

The table below shows the band of switch on/off and the hysteresis.

Table 9: Trigger level and hysteresis (pin 1 left open)

Model	Trigger level	Hysteresis	Unit
20IMX35	7 to 8	<0.5	V
40IMX35	14 to 15.5	<1	
70IMX35	31 to 34	<3	
110IMX35	42 to 50	<8	

The undervoltage lockout levels may be programmed by using an external resistor R_{PUL} between PUL and V_{i-} to increase the preset levels as specified in table 10.

Table 10: Typical values for R_{PUL} and the respective lockout voltage for input voltage.

20IMX35		40IMX35	
R_{PUL} [kW]	$V_{i\ min}$ [V]	R_{PUL} [kW]	$V_{i\ min}$ [V]
∞	≤ 8	∞	≤ 15.5
39	10	43	22
19	12	16	26
13	14	10	28
9.1	16	0	32

70IMX35		110IMX35	
R_{PUL} [kW]	$V_{i\ min}$ [V]	R_{PUL} [kW]	$V_{i\ min}$ [V]
∞	31	∞	42
270	40	270	50
110	50	120	60
80	55	51	75

Electromagnetic Compatibility (EMC)

A suppressor diode together with an input filter form an

effective protection against high input transient voltages which typically occur in many installations, but especially in battery-driven mobile applications.

Electromagnetic Immunity

Table 11: Immunity type tests

Phenomenon	Standard	Class Level	Coupling mode ¹	Value applied	Waveform	Source imped.	Test procedure	In oper.	Perf. crit. ²
Electrostatic discharge to case	IEC/EN 61000-4-2	2	contact discharge (Trim pin open)	4000 V _p	1/50 ns	330 Ω	10 positive and 10 negative discharges	yes	B
		3	air discharge (Trim pin open)	8000 V _p					
Electromagnetic field	IEC/EN 61000-4-3	3 ³	antenna	10 V/m	AM 80% 1 kHz	n.a.	80 to 1000 MHz	yes	A
	ENV 50204	3	antenna	10 V/m	PM, 50% duty cycle, 200 Hz repetition frequ.	n.a.	900 MHz	yes	A
Electrical fast transients/burst	IEC/EN 61000-4-4	4	direct +i/-i	±4000 V _p	bursts of 5/50ns 2.5/5 kHz over 15 ms, burst period 300 ms	50 Ω	60 s positive, 60 s negative transients per coupling mode	yes	B
Surges	IEC/EN 61000-4-5	3 ⁴	+i/-i	±2000 V _p	1.2/50 μs	2 Ω	5 pos. and 5 neg. surges	yes	B
	EN 50155:2001	A ⁵	+i/c, -i/c	±1800 V _p	5/50 μs	100 Ω		yes	B
		B ⁶	+i/c, -i/c	8400 V _p	0.05/0.1 μs	100 Ω		yes	B
RF Conducted immunity	IEC/EN 61000-4-6	3	+i/-i	10 VAC (140 dBμV)	AM modulated 80%, 1 kHz	50 Ω	0.15 to 80 MHz 150 Ω	yes	A

¹ i = input, o = output, c = case (not with option Z)

² A = normal operation, no deviation from specification, B = temporary deviation from specs. possible.

³ Corresponds to EN 50121-3-2:2000, table 9.1

⁴ External components required; see fig. 4

⁵ Corresponds to EN 50155:1995, waveform D

⁶ Corresponds to EN 50155:1995, waveform G

Electromagnetic Emissions



Fig. 14

Typ. disturbances (quasi-peak and average) at the input according to EN 55011/22, measured at $V_{i\text{nom}}$ and $I_{o\text{nom}}$ (110IMX35D05D12-8 with input choke 2×1.1 mH).

Conducted emission according to EN 55011/55022, class A, can be achieved by adding an external common mode choke and an additional ceramic capacitor. The filter components should be placed as close as possible to the input of the converter; see figure 15.

Table 12: Input filter components

Model	Common mode choke L_1 (Murata)	Ceramic cap C_1
20IMX35	70 μ H / 3.6 A, PLH10AN7003R6P2	4.7 μ F / 50 V
40IMX35	160 μ H / 2.1 A, PLH10AN1612R1P2	2.2 μ F / 100 V
70IMX35	290 μ H / 1.2 A, PLH10AN2911R2P2	1 μ F / 200 V
110IMX35	370 μ H / 1.0 A, PLH10AN3711R0P2	1 μ F / 200 V



Fig. 15
External filter circuitry

Immunity to Environmental Conditions

Table 13: Mechanical and climatic stress

Test method		Standard	Test conditions	Status
Cab	Damp heat steady state	IEC/EN 60068-2-78 MIL-STD-810D section 507.2	Temperature: 40 \pm 2 $^{\circ}$ C Relative humidity: 93 $^{+2/-3}$ % Duration: 56 days	Converter not operating
--	Salt mist test sodium chloride (NaCl) solution ²	EN 50155:2007 sect. 12.2.10 class ST3 ²	Temperature: 35 \pm 2 $^{\circ}$ C Duration: 48 h	Converter not operating
Eb	Bump (half-sinusoidal)	IEC/EN 60068-2-29 MIL-STD-810D section 516.3	Acceleration amplitude: 25 $g_n = 245$ m/s ² Bump duration: 6 ms Number of bumps: 6000 (1000 in each direction)	Converter operating
Fc	Vibration (sinusoidal)	IEC/EN 60068-2-6 MIL-STD-810D section 514.3	Acceleration amplitude: 0.35 mm (10 – 60 Hz) 5 $g_n = 49$ m/s ² (60 - 2000 Hz) Frequency (1 Oct/min): 10 – 2000 Hz Test duration: 7.5 h (2.5 h in each axis)	Converter operating
Fh	Random vibration broad-band (digital control) and guidance	IEC/EN 60068-2-64	Acceleration spectral density: 0.05 g_n^2 /Hz Frequency band: 8 – 500 Hz Acceleration magnitude: 4.9 g_{rms} Test duration: 1.5 h (0.5 h in each axis)	Converter operating
Ea	Shock (half-sinusoidal)	IEC/EN 60068-2-27 MIL-STD-810D section 516.3	Acceleration amplitude: 50 $g_n = 490$ m/s ² Bump duration: 11 ms Number of bumps: 18 (3 in each direction)	Converter operating
--	Shock	EN 50155:2007 sect. 12.2.11 EN 61373 sect. 10, class B, body mounted ¹	Acceleration amplitude: 5.1 g_n Bump duration: 30 ms Number of bumps: 18 (3 in each direction)	Converter operating
--	Simulated long life testing at increased random vibration levels	EN 50155:2007 sect. 12.2.11 EN 61373 sect. 8 and 9, Body mounted ¹	Acceleration spectral density: 0.02 g_n^2 /Hz Frequency band: 5 – 150 Hz Acceleration magnitude: 0.8 $g_{n,rms}$ Test duration: 15 h (5 h in each axis)	Converter operating

¹ Body mounted = chassis of a railway coach

² Models without option Z

Temperatures

Table 14: Temperature specifications, valid for air pressure of 800 to 1200 hPa (800 to 1200 mbar)

Temperature		-8		Unit	
Characteristics	Conditions	min	max		
T_A	Ambient temperature	Operational ¹	-40 ³	°C	
T_C	Case temperature (without opt. Z) ²		-40 ³		85 ¹
T_{CZ}	Component temp. with opt. Z ²		-40 ³		105 ²
T_S	Storage temperature	Non operational	-55	105	

¹ See *Thermal Considerations*

² Temperature measurement point; see *Mechanical Data*

³ Start-up at -55 °C

Reliability

Table 15: MTBF at nom. load

Model	Ground benign 40 °C	Ground fixed		Ground mobile 50 °C	Device hours ¹	Unit
		40 °C	70 °C			
40IMX35 (MIL-HDBK-217F, T_C)	336 000	141 000	86 000	110 000	396 000	h
110IMX35 (Bellcore, T_A)	1445 000	529 000	294 000	144 000		

¹ The device hours are based upon the IMX35 series field failure rate recorded between 2000 and 2005

Mechanical Data

Dimensions in mm. Tolerances ± 0.3 mm, unless noted.

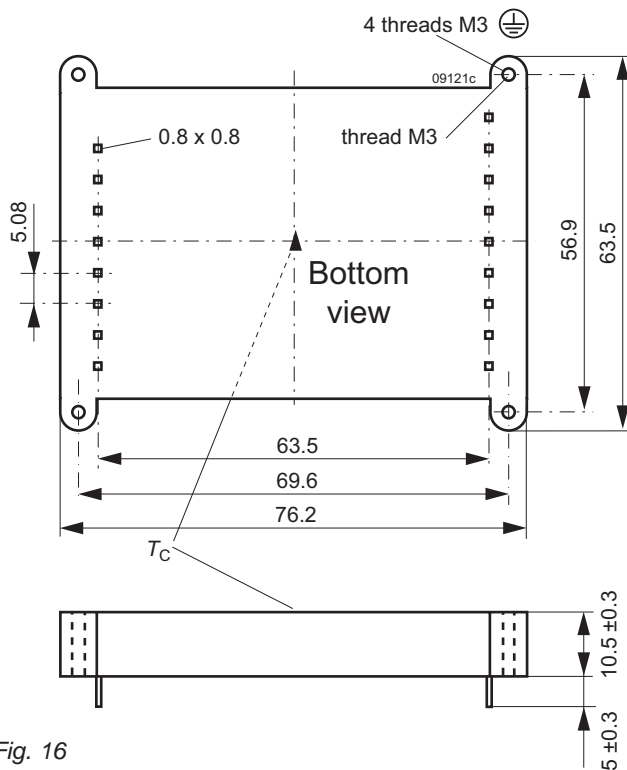

Fig. 16
 Case IMX35 (Standard)
 Material: Zinc; weight: approx. 67 g

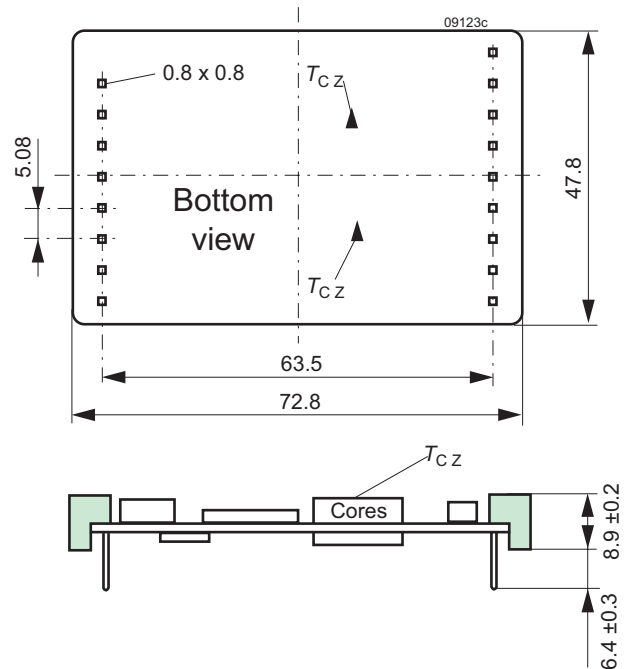

Fig. 17
 Case IMX35 open frame (option Z)
 Weight: approx. 43 g

Safety and Installation Instructions

Pin allocation

Table 16: Pin allocation

Pin No.	Quadruple output
1	PUL
2	Vi-
3	n.c.
4	Vi+
5	Trim or Trim1
6	W
7	Ref
8	\overline{SD} or i
11	Vo3-
12	Vo3+
13	Vo2+
14	Vo2-
15	Vo1-
16	Vo1+
17	Vo4+
18	Vo4-
19	n.c.



Fig. 18

Footprint. The holes in the PCB should have a diameter of 1.5 mm.

Installation Instructions

Installation of the converters must strictly follow the national safety regulations in compliance with the enclosure, mounting, creepage, clearance, casualty, markings, and segregation requirements of the end-use application.

Connection to the system shall be made via a printed circuit board with hole diameters of 1.5 mm for the pins.

The converters should be connected to a secondary circuit.

Do not open the converter.

Ensure that a converter failure (e.g., by an internal short-circuit) does not result in a hazardous condition.

Input Fuse

To prevent excessive current flowing through the input supply line in case of a short-circuit in the converter, an external fuse should be installed in the non-earthed input line. We recommend a fast acting fuse specified in table 3.

Standards and Approvals

All converters are safety-approved to IEC/EN 60950-1 and UL/CSA 60950-1 2nd Ed.

The converters have been evaluated for:

- Building-in
- Basic insulation input to output, based on their maximum input voltage
- Pollution degree 2 (not option Z)
- Connecting the input to a secondary circuit, which is subject to a maximum transient rating of 1500 V.

The converters are subject to manufacturing surveillance in accordance with the above mentioned standards.

CB scheme is available.

Railway Applications

To comply with Railway standards, all components are coated with a protective lacquer (except for option Z).

Protection Degree and Cleaning Liquids

The protection degree is IP 30 (not for option Z). In order to avoid damage, any penetration of cleaning fluids should be prevented, since the converters are not hermetically sealed.

However, open-frame models (option Z) leave the factory unlacquered; they may be lacquered by the customer, for instance together with the mother board. Cleaning liquids are not permitted – except washing at room temperature with isopropyl alcohol and de-ionized/distilled water (1 : 1).

Note: Cleaning liquids can damage the adhesive joints of the ferrite cores.

Isolation

The electric strength test is performed in the factory as a routine test in accordance with EN 50514, EN 60950, and UL 60950 and should not be repeated in the field. The Company will not honor any warranty claims resulting from electric strength field tests.

Table 17: Electric strength test voltages

Characteristic	Input to (outputs+case) 20/40IMX35 ³	Input to (outputs+case) 70/110IMX35 ³	Outputs to case all models ³	Between outputs all models	Unit
Factory test >1 s	1.2 / 1.5 ¹	1.8	0.5	0.15 ²	kVAC
Equivalent DC voltage	1.5 / 2.1 ¹	2.5	0.7	0.2 ²	kVDC
Insulation resistance at 500 VDC	>100	>100	–	–	MΩ

¹ 1.5 kVAC according to IEC 60950, sect. 6.2, Telecom equipment; type test with 1.5 kVAC / 60 s (IEE 802.3). IMX35 units produced before 2013 were tested with 1.2 kVAC only.

² The test voltage between outputs is not applied as routine test.

³ For open-frame models (option Z), only the insulation input to outputs is tested.

Options

i: Inhibit (Negative Shutdown Logic)

The outputs of the converter may be enabled or disabled by means of a logic signal (TTL, CMOS, etc.) applied to the inhibit pin 8. If the inhibit function is not required the inhibit (pin 8)



Fig. 19

If the inhibit pin is not used, connect it to Vi-.

should be connected to Vi- to enable the output (active low logic, fail safe).

Voltage at pin 8:

Converter operating:	-10 V to 0.8 V
Converter disabled:	2.4 V to 20 V or left open-circuit

Z: Open Frame

For applications, where the protection by a housing is not necessary or in the case that the motherboard should be lacquered after fitting the converter.

Note: The converters shall not be exposed to cleaning processes, as this will damage the glue of the ferrite cores.

G: RoHS-6

Converters with a type designation ending by G are RoHS-compliant for all six substances.

NUCLEAR AND MEDICAL APPLICATIONS - These products are not designed or intended for use as critical components in life support systems, equipment used in hazardous environments, or nuclear control systems.

TECHNICAL REVISIONS - The appearance of products, including safety agency certifications pictured on labels, may change depending on the date manufactured. Specifications are subject to change without notice.

Copyright © 2015, Bel Power Solutions Inc. All rights reserved.

www.belpowersolutions.com/power

Mouser Electronics

Authorized Distributor

Click to View Pricing, Inventory, Delivery & Lifecycle Information:

Bel Power Solutions:

[20IMX35D05D15-8G](#) [20IMX35D05D05-8G](#) [20IMX35D12D12-8G](#) [20IMX35D15D15-8G](#) [40IMX35D05D12-8-G](#)
[40IMX35D05D15-8-G](#) [70IMX35D05D12-8G](#) [110IMX35D05D05-8G](#) [110IMX35D12D12-8G](#) [40IMX35D12D12-8-G](#)
[110IMX35D05D12-8G](#) [40IMX35D05D05-8-G](#) [70IMX35D05D15-8G](#) [110IMX35D15D15-8G](#) [20IMX35D05D12-8G](#)
[70IMX35D15D15-8G](#) [70IMX35D12D12-8G](#) [110IMX35D05D15-8G](#) [70IMX35D05D05-8G](#) [40IMX35D15D15-8](#)
[70IMX35D05D15-8Z](#) [40IMX35D12D12-8IZ](#) [20IMX35D05D12-8ZG](#) [70IMX35D05D12-8](#) [110IMX35D15D15-8](#)
[40IMX35D12D12-8](#) [40IMX35D05D15-8](#) [110IMX35D05D05-8](#) [70IMX35D12D12-8](#) [110IMX35D12D12-8](#)
[70IMX35D05D15-8](#) [20IMX35D05D05-8](#) [20IMX35D15D15-8](#) [20IMX35D05D15-8](#) [20IMX35D12D12-8](#)
[40IMX35D15D15-8G](#) [40IMX35D05D12-8](#) [40IMX35D05D05-8](#) [20IMX35D05D12-8](#) [70IMX35D05D05-8](#)