

# General Specifications

## Electrical Capacity (Resistive Load)

**Logic Level:** 0.4VA maximum @ 28V AC/DC maximum  
(Applicable Range 0.1mA ~ 0.1A @ 20mV ~ 28V)  
Note: Find additional explanation of operating range in Supplement section.

## Other Ratings

**Contact Resistance:** 80 milliohms maximum  
**Insulation Resistance:** 500 megohms minimum @ 500V DC  
**Dielectric Strength:** 500V AC minimum for 1 minute minimum  
**Mechanical Life:** 50,000 operations minimum  
**Electrical Life:** 50,000 operations minimum  
**Nominal Operating Force:** 1.70N  
**Travel:** Pretravel .035" (0.9mm); Overtravel .008" (0.2mm); Total Travel .043" (1.1mm)

## Materials & Finishes

**Actuator:** Polyacetal  
**Case:** Glass fiber reinforced polyamide  
**Sealing Rings:** Nitrile butadiene rubber  
**Movable Contacts:** Phosphor bronze with gold plating  
**Stationary Contacts:** Phosphor bronze with gold plating  
**Base:** Glass fiber reinforced polyamide  
**Mounting Bracket:** Phosphor bronze with tin plating  
**Terminals:** Phosphor bronze with gold plating

## Environmental Data

**Operating Temp Range:** -30°C through +85°C (-22°F through +185°F)  
**Humidity:** 90 ~ 95% humidity for 96 hours @ 40°C (104°F)  
**Vibration:** 10 ~ 55Hz with peak-to-peak amplitude of 1.5mm traversing the frequency range & returning in 1 minute; 3 right angled directions for 2 hours  
**Shock:** 50G (490m/s<sup>2</sup>) acceleration (tested in 6 right angled directions, with 5 shocks in each direction)

## Installation

**Cap Installation Force:** 39.1N (8.8 lbf) maximum downward force on actuator

## PCB Processing

**Soldering:** Wave Soldering Recommended: See Profile A in Supplement section.  
Manual Soldering: See Profile A in Supplement section.  
**Cleaning:** Automated cleaning. See Cleaning specifications in Supplement section.

## Standards & Certifications

The GB Series pushbuttons have not been tested for UL recognition or CSA certification. These switches are designed for use in a low-voltage, low-current, logic-level circuit. When used as intended in a logic-level circuit, the results do not produce hazardous energy.

# Distinctive Characteristics

Ultra-miniature size allows high density mounting, and extremely light weight of 0.25 gram makes these switches ideal for handheld equipment.

Totally sealed body construction prevents contact contamination and allows time- and money-saving automated soldering and cleaning.

Award-winning STC contact mechanism with benefits unavailable in conventional mechanisms: smoother, positive detent actuation, increased contact stability and unparalleled logic-level reliability. (Additional STC details in Terms & Acronyms; see Supplement section.)

.100" x .100" (2.54mm x 2.54mm) terminal spacing conforms to standard PC board grid-spacing. Round terminals facilitate easier through-hole mounting on PC boards.

Matching indicators available.

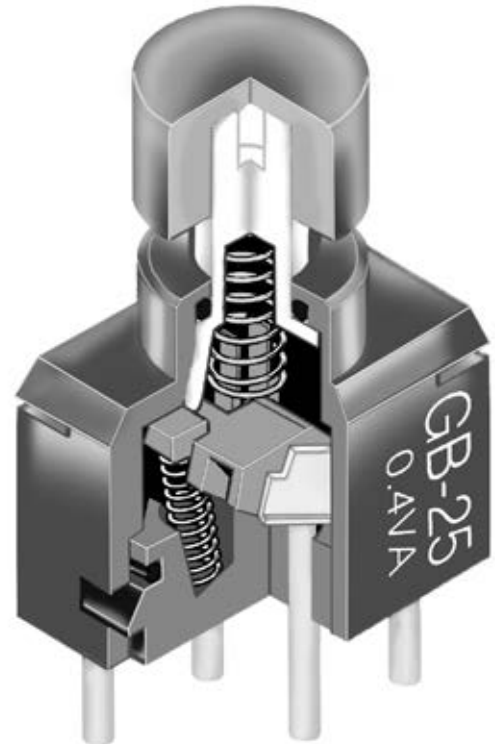

Actual Size

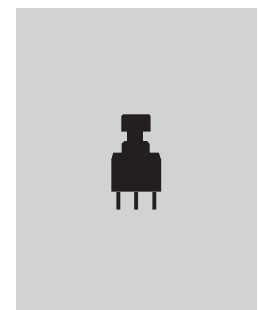

- Supplement
- Accessories
- Indicators
- Touch
- Tilt
- Tactiles
- Slides
- Rotaries
- Keylocks
- Programmable
- Illuminated PB
- Pushbuttons
- Rockers
- Toggles

### TYPICAL SWITCH ORDERING EXAMPLE

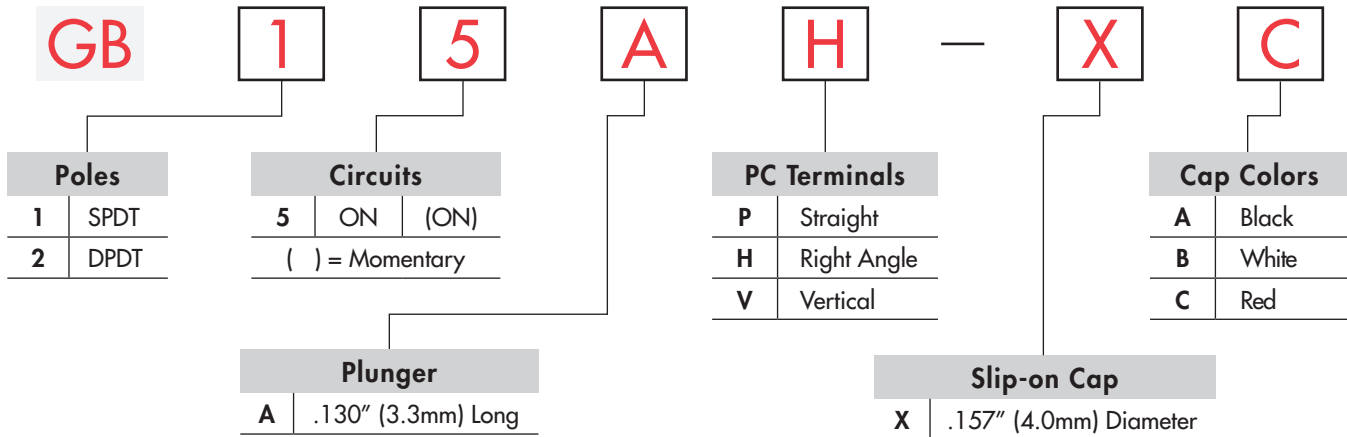

### DESCRIPTION FOR TYPICAL ORDERING EXAMPLE

#### GB15AH-XC

.130" (3.3mm) Long Plunger with  
.157" (4.0mm) Diameter Red Cap



SPDT  
ON-(ON) Circuit  
Right Angle PC Terminals

### POLES & CIRCUITS

Pole	Model	Plunger Position ( ) = Momentary		Connected Terminals		Throw & Schematics
		Normal 	Down 	Normal 	Down 	
SP	GB15	ON	(ON)	5-6	5-4	SPDT 
DP	GB25	ON	(ON)	5-6 2-3	5-4 2-1	DPDT 

Note: Terminal numbers are not actually on the switch.

### PLUNGER

**A** .130" (3.3mm) Long Plunger

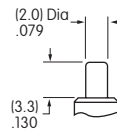

### PC TERMINALS

**P** Straight

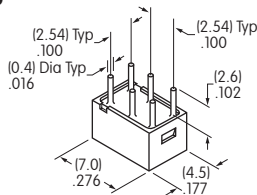

**H** Right Angle

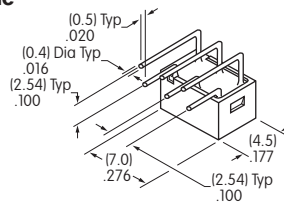

**V** Vertical

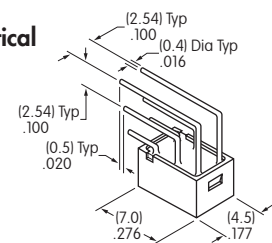

## SLIP-ON CAP & COLORS

**X** **AT4063**  
**.157" (4.0mm) Diameter Slip-on Cap**

Material: Polyamide

Finish: Glossy



Actual Size

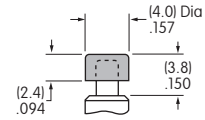

Cap Colors Available:



Black



White



Red

## TYPICAL SWITCH DIMENSIONS

### Single & Double Pole

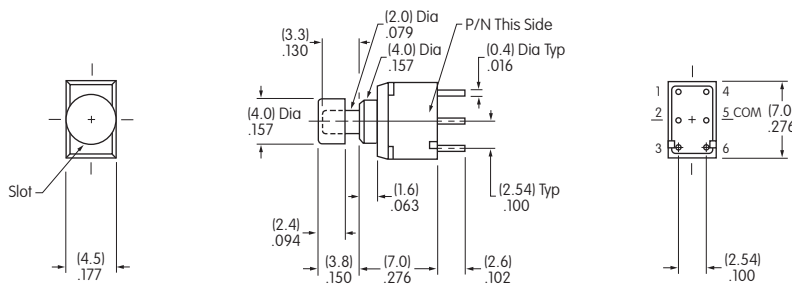

On single pole switches terminals 1 & 3 are support pins.

### Straight PC

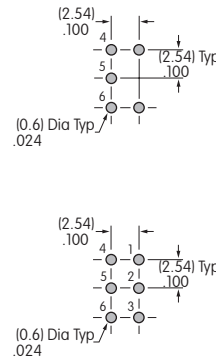

**GB25AP-XC**

### Single & Double Pole

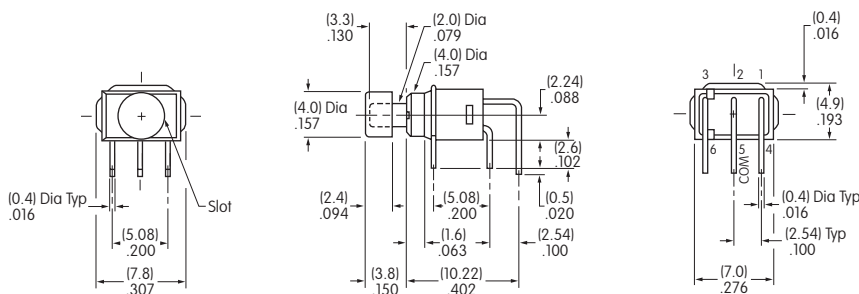

### Right Angle PC

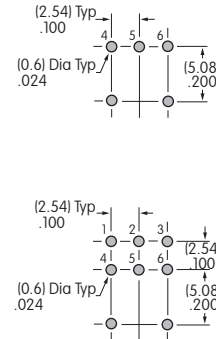

**GB25AH-XC**

### Single & Double Pole

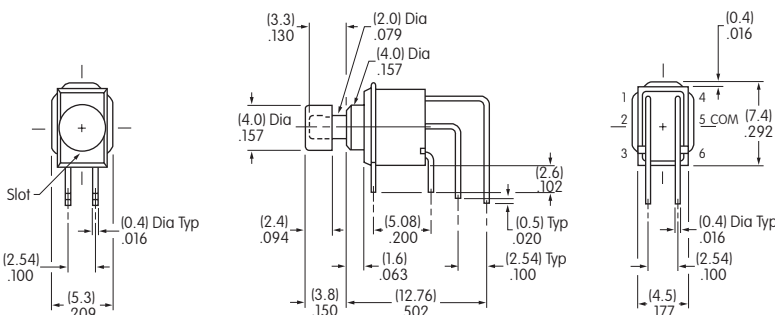

### Vertical PC

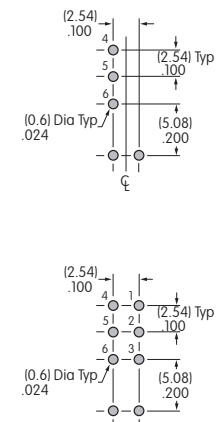

**GB25AV-XC**

# Mouser Electronics

Authorized Distributor

Click to View Pricing, Inventory, Delivery & Lifecycle Information:

## [NKK Switches:](#)

[GB15AH](#) [GB25AP](#) [GB25AP-XA](#) [GB25AP-XC](#) [GB15AV-XG](#) [GB15AP-XA](#) [GB15AP-XB](#) [GB25AP-XB](#) [GB25AV-XA](#)  
[GB25AH-XB](#) [GB25AH-XC](#) [GB15AV-XB](#) [GB15AH-XC](#) [GB15AH-XA](#) [GB25AH](#) [GB15AP](#) [GB15AV-XA](#) [GB15AH-XB](#)  
[GB25AV-XC](#) [GB25AV](#) [GB25AH-XA](#) [GB15AV-XC](#) [GB15AP-XC](#) [GB15AV](#)