

IRG4PF50WDPbF

INSULATED GATE BIPOLAR TRANSISTOR WITH
 ULTRAFAST SOFT RECOVERY DIODE

Features

- Optimized for use in Welding and Switch-Mode Power Supply applications
- Industry benchmark switching losses improve efficiency of all power supply topologies
- 50% reduction of Eoff parameter
- Low IGBT conduction losses
- Latest technology IGBT design offers tighter parameter distribution coupled with exceptional reliability
- IGBT co-packaged with HEXFRED™ ultrafast, ultra-soft-recovery anti-parallel diodes for use in bridge configurations
- Industry standard TO-247AC package
 - Lead-Free

Benefits

- Lower switching losses allow more cost-effective operation and hence efficient replacement of larger-die MOSFETs up to 100kHz
- HEXFRED™ diodes optimized for performance with IGBTs. Minimized recovery characteristics reduce noise, EMI and switching losses

Absolute Maximum Ratings

	Parameter	Max.	Units
V_{CES}	Collector-to-Emitter Breakdown Voltage	900	V
$I_C @ T_C = 25^\circ\text{C}$	Continuous Collector Current	51	A
$I_C @ T_C = 100^\circ\text{C}$	Continuous Collector Current	28	
I_{CM}	Pulsed Collector Current ①	204	
I_{LM}	Clamped Inductive Load Current ②	204	
$I_F @ T_C = 100^\circ\text{C}$	Diode Continuous Forward Current	16	
I_{FM}	Diode Maximum Forward Current	204	
V_{GE}	Gate-to-Emitter Voltage	± 20	V
$P_D @ T_C = 25^\circ\text{C}$	Maximum Power Dissipation	200	W
$P_D @ T_C = 100^\circ\text{C}$	Maximum Power Dissipation	78	
T_J	Operating Junction and	-55 to + 150	°C
T_{STG}	Storage Temperature Range		
	Soldering Temperature, for 10 seconds	300 (0.063 in. (1.6mm) from case)	
	Mounting torque, 6-32 or M3 screw.	10 lbf·in (1.1N·m)	

Thermal Resistance

	Parameter	Min.	Typ.	Max.	Units
$R_{\theta JC}$	Junction-to-Case - IGBT	—	—	0.64	°C/W
$R_{\theta JC}$	Junction-to-Case - Diode	—	—	0.83	
$R_{\theta CS}$	Case-to-Sink, flat, greased surface	—	0.24	—	
$R_{\theta JA}$	Junction-to-Ambient, typical socket mount	—	—	40	
Wt	Weight	—	6 (0.21)	—	g (oz)

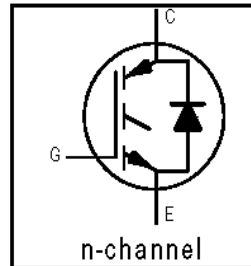

$V_{CES} = 900\text{V}$
$V_{CE(on)} \text{ typ.} = 2.25\text{V}$
@ $V_{GE} = 15\text{V}, I_C = 28\text{A}$

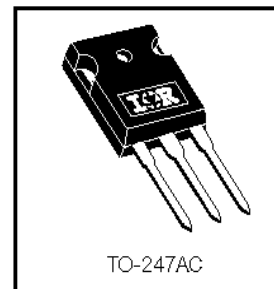

IRG4PF50WDPbF

International
IR Rectifier

Electrical Characteristics @ $T_J = 25^\circ\text{C}$ (unless otherwise specified)

	Parameter	Min.	Typ.	Max.	Units	Conditions
$V_{(BR)CES}$	Collector-to-Emitter Breakdown Voltage ^③	900	—	—	V	$V_{GE} = 0V, I_C = 250\mu A$
$\Delta V_{(BR)CES}/\Delta T_J$	Temperature Coeff. of Breakdown Voltage	—	0.295	—	V/°C	$V_{GE} = 0V, I_C = 3.5mA$
$V_{CE(on)}$	Collector-to-Emitter Saturation Voltage	—	2.25	2.7	V	$I_C = 28A, V_{GE} = 15V$
		—	2.74	—		$I_C = 60A$ See Fig. 2, 5
		—	2.12	—		$I_C = 28A, T_J = 150^\circ\text{C}$
$V_{GE(th)}$	Gate Threshold Voltage	3.0	—	6.0		$V_{CE} = V_{GE}, I_C = 250\mu A$
$\Delta V_{GE(th)}/\Delta T_J$	Temperature Coeff. of Threshold Voltage	—	-13	—	mV/°C	$V_{CE} = V_{GE}, I_C = 250\mu A$
g_{fe}	Forward Transconductance ^④	26	39	—	S	$V_{CE} = 50V, I_C = 28A$
I_{CES}	Zero Gate Voltage Collector Current	—	—	500	μA	$V_{GE} = 0V, V_{CE} = 900V$
		—	—	2.0		$V_{GE} = 0V, V_{CE} = 10V, T_J = 25^\circ\text{C}$
		—	—	6.5	mA	$V_{GE} = 0V, V_{CE} = 900V, T_J = 150^\circ\text{C}$
V_{FM}	Diode Forward Voltage Drop	—	2.5	3.5	V	$I_C = 16A$ See Fig. 13
		—	2.1	3.0		$I_C = 16A, T_J = 150^\circ\text{C}$
I_{GES}	Gate-to-Emitter Leakage Current	—	—	± 100	nA	$V_{GE} = \pm 20V$

Switching Characteristics @ $T_J = 25^\circ\text{C}$ (unless otherwise specified)

	Parameter	Min.	Typ.	Max.	Units	Conditions
Q_g	Total Gate Charge (turn-on)	—	160	240	nC	$I_C = 28A$ $V_{CC} = 400V$ See Fig. 8 $V_{GE} = 15V$
Q_{ge}	Gate - Emitter Charge (turn-on)	—	19	29		
Q_{gc}	Gate - Collector Charge (turn-on)	—	53	80		
$t_{d(on)}$	Turn-On Delay Time	—	71	—	ns	$T_J = 25^\circ\text{C}$ $I_C = 28A, V_{CC} = 720V$ $V_{GE} = 15V, R_G = 5.0\Omega$ Energy losses include "tail" and diode reverse recovery.
t_r	Rise Time	—	50	—		
$t_{d(off)}$	Turn-Off Delay Time	—	150	220		
t_f	Fall Time	—	110	170	mJ	See Fig. 9, 10, 18
E_{on}	Turn-On Switching Loss	—	2.63	—		
E_{off}	Turn-Off Switching Loss	—	1.34	—		
E_{ts}	Total Switching Loss	—	3.97	5.3	ns	$T_J = 150^\circ\text{C}$, See Fig. 11, 18 $I_C = 28A, V_{CC} = 720V$ $V_{GE} = 15V, R_G = 5.0\Omega$ Energy losses include "tail" and diode reverse recovery.
$t_{d(on)}$	Turn-On Delay Time	—	69	—		
t_r	Rise Time	—	52	—		
$t_{d(off)}$	Turn-Off Delay Time	—	270	—	mJ	Measured 5mm from package
t_f	Fall Time	—	190	—		
E_{ts}	Total Switching Loss	—	6.0	—		
L_E	Internal Emitter Inductance	—	13	—	nH	
C_{ies}	Input Capacitance	—	3300	—	pF	$V_{GE} = 0V$ $V_{CC} = 30V$ See Fig. 7 $f = 1.0MHz$
C_{oes}	Output Capacitance	—	200	—		
C_{res}	Reverse Transfer Capacitance	—	45	—		
t_{rr}	Diode Reverse Recovery Time	—	90	135	ns	$T_J = 25^\circ\text{C}$ See Fig. 14 $T_J = 125^\circ\text{C}$ 14
		—	164	245		
I_{rr}	Diode Peak Reverse Recovery Current	—	5.8	10	A	$T_J = 25^\circ\text{C}$ See Fig. 15 $T_J = 125^\circ\text{C}$ 15
		—	8.3	15		
Q_{rr}	Diode Reverse Recovery Charge	—	260	675	nC	$T_J = 25^\circ\text{C}$ See Fig. 16 $T_J = 125^\circ\text{C}$ 16
		—	680	1838		
$di_{(rec)M}/dt$	Diode Peak Rate of Fall of Recovery During t_b	—	120	—	A/ μs	$T_J = 25^\circ\text{C}$ See Fig. 17 $T_J = 125^\circ\text{C}$ 17
		—	76	—		

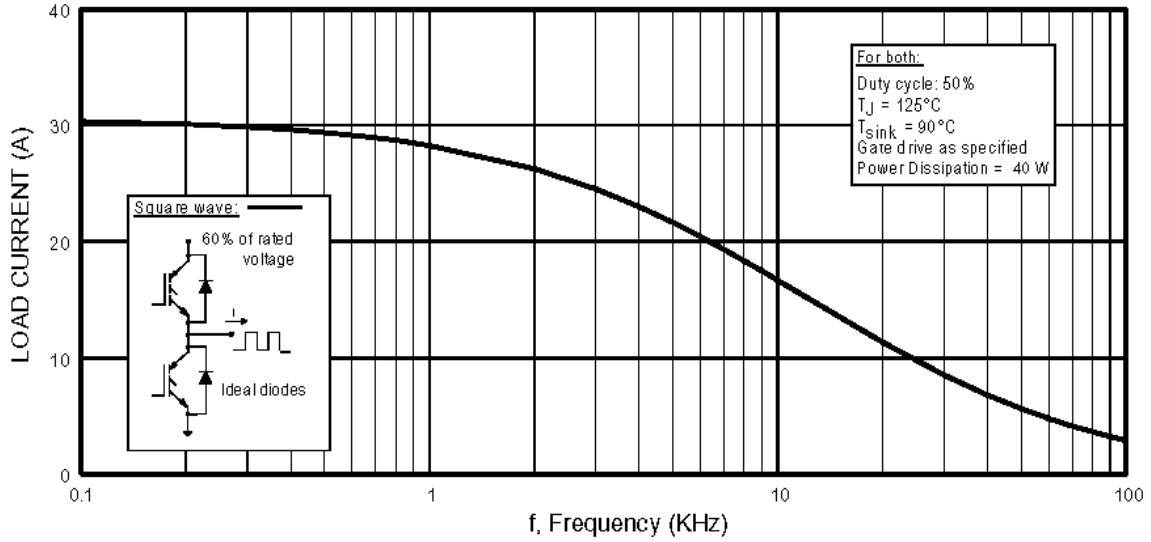

Fig. 1 - Typical Load Current vs. Frequency
 (Load Current = I_{RMS} of fundamental)

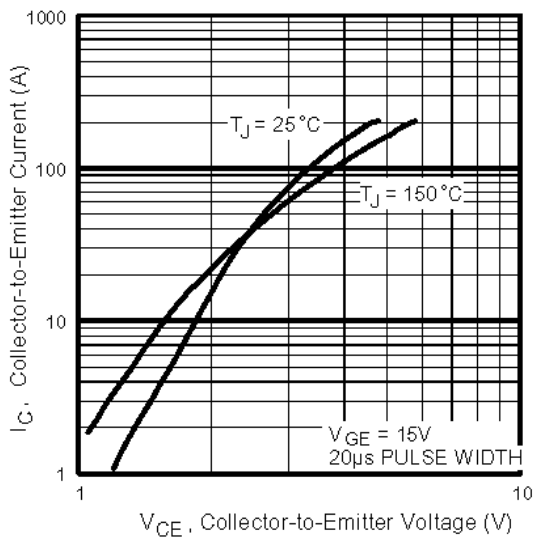

Fig. 2 - Typical Output Characteristics
www.irf.com

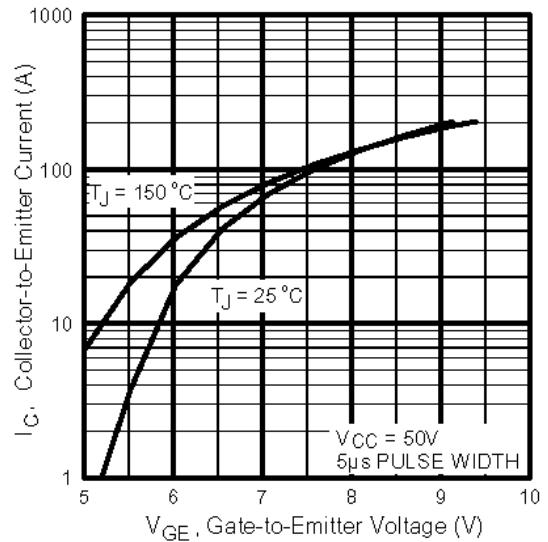

Fig. 3 - Typical Transfer Characteristics

IRG4PF50WDPbF

International
IR Rectifier

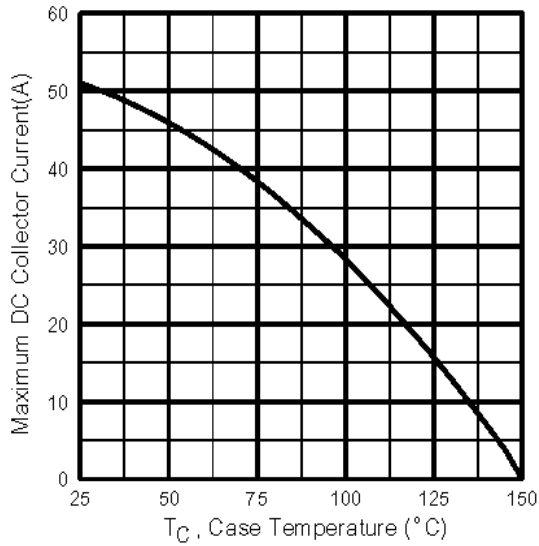

Fig. 4 - Maximum Collector Current vs. Case Temperature

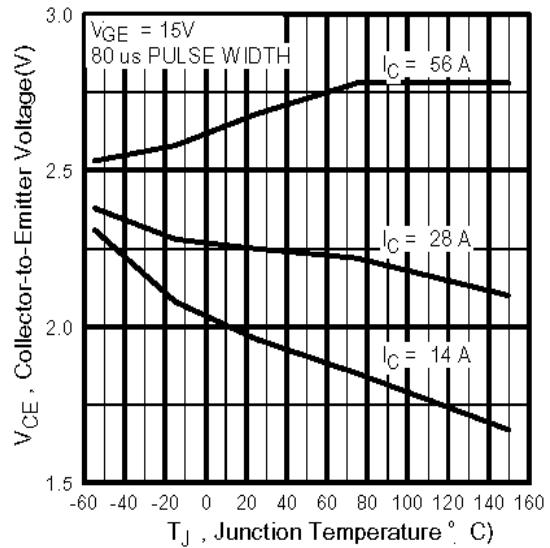

Fig. 5 - Collector-to-Emitter Voltage vs. Junction Temperature

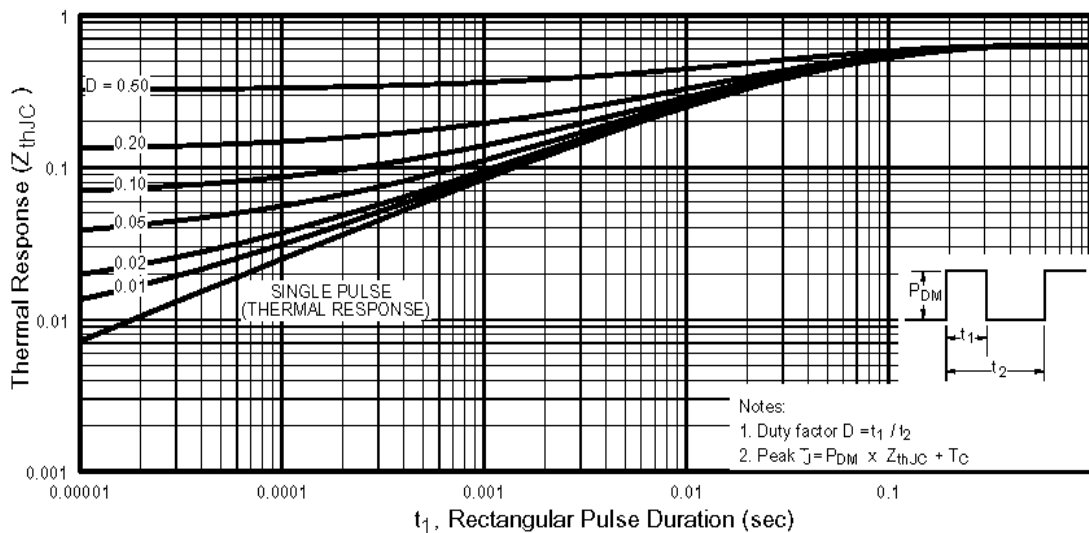

Fig. 6 - Maximum Effective Transient Thermal Impedance, Junction-to-Case

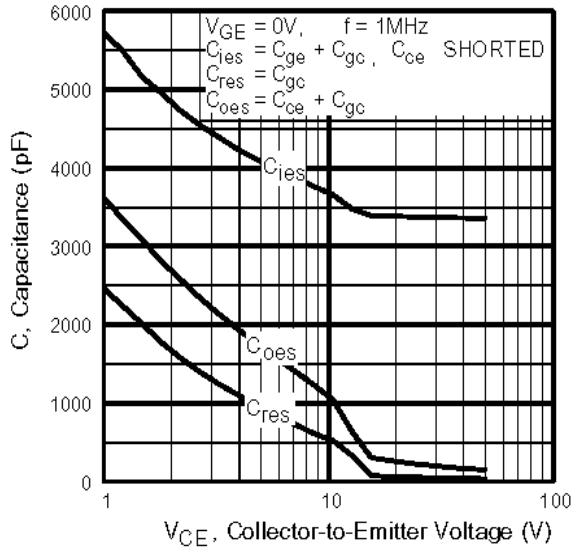

Fig. 7 - Typical Capacitance vs. Collector-to-Emitter Voltage

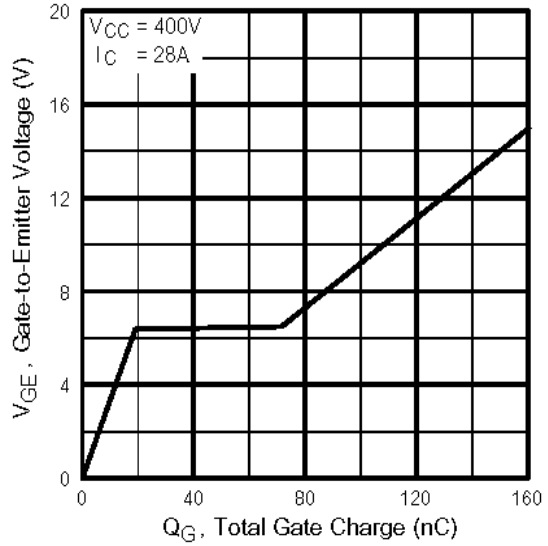

Fig. 8 - Typical Gate Charge vs. Gate-to-Emitter Voltage

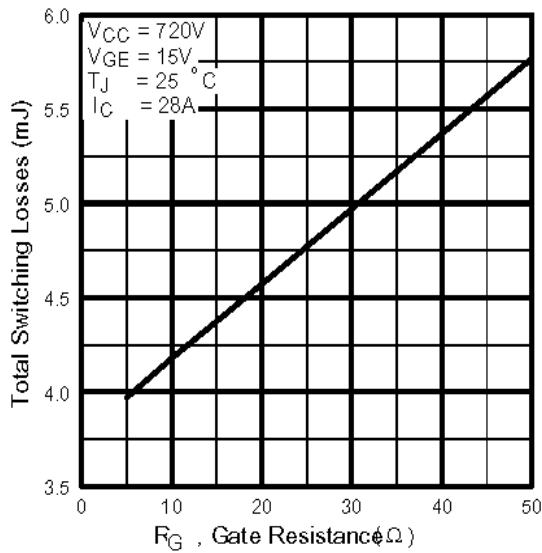

Fig. 9 - Typical Switching Losses vs. Gate Resistance

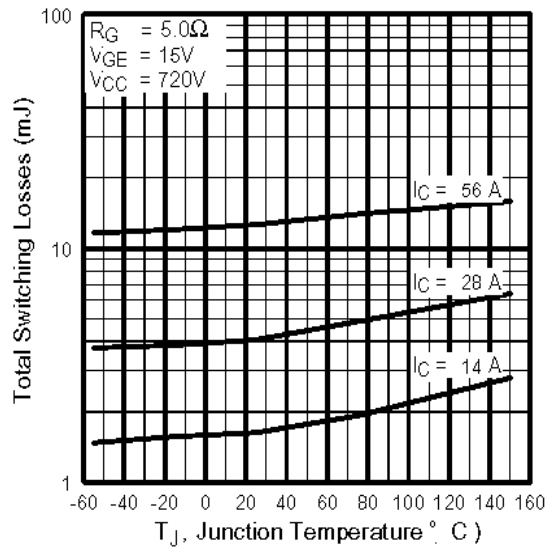

Fig. 10 - Typical Switching Losses vs. Junction Temperature

IRG4PF50WDPbF

International
IR Rectifier

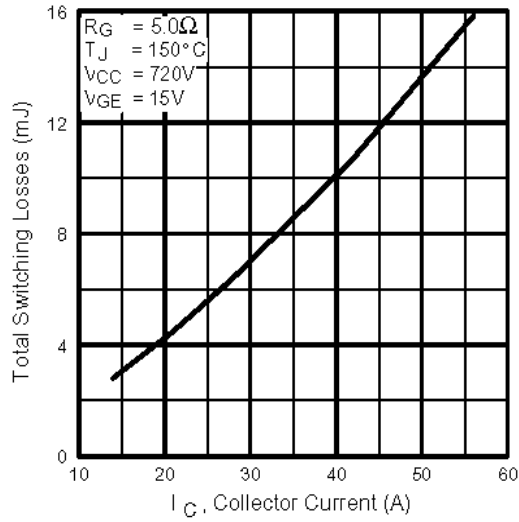

Fig. 11 - Typical Switching Losses vs. Collector-to-Emitter Current

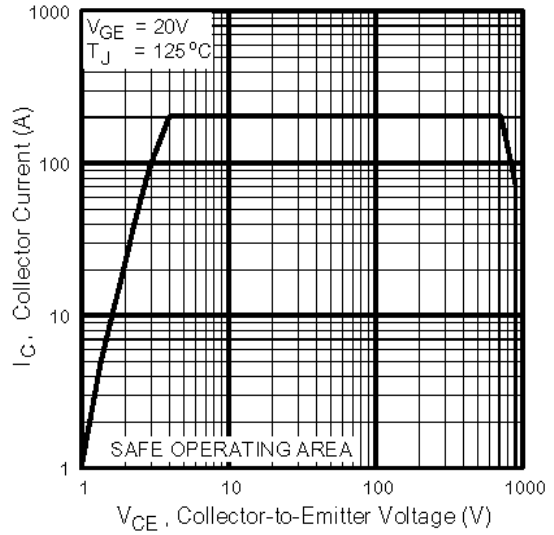

Fig. 12 - Turn-Off SOA

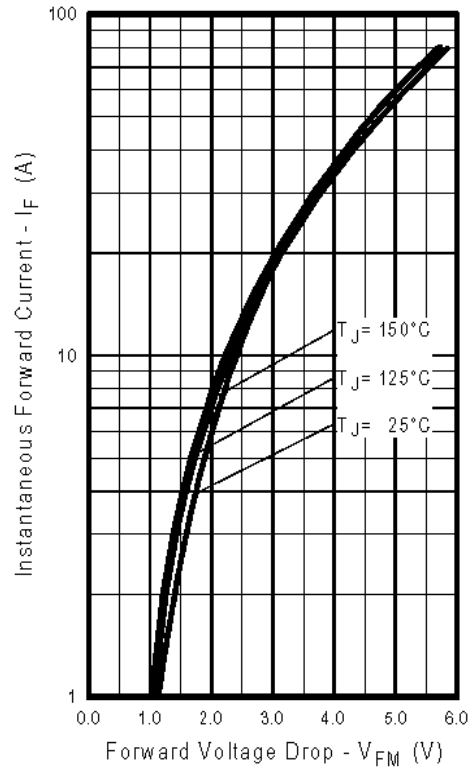

Fig. 13 - Typical Forward Voltage Drop vs. Instantaneous Forward Current

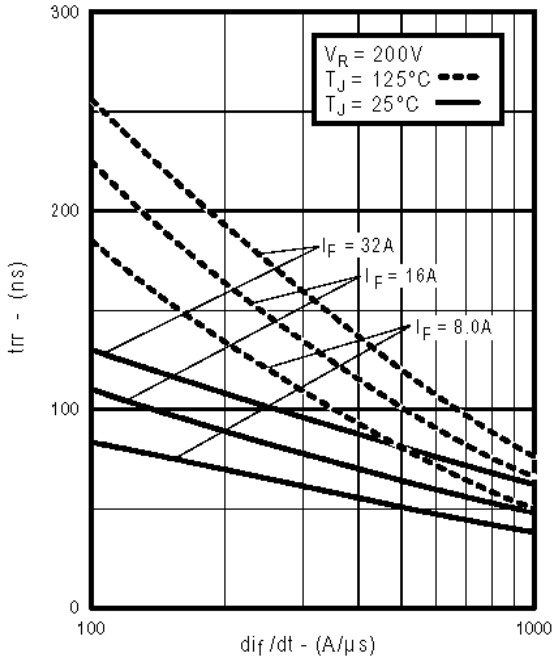

Fig. 14 - Typical Reverse Recovery vs. di_f/dt

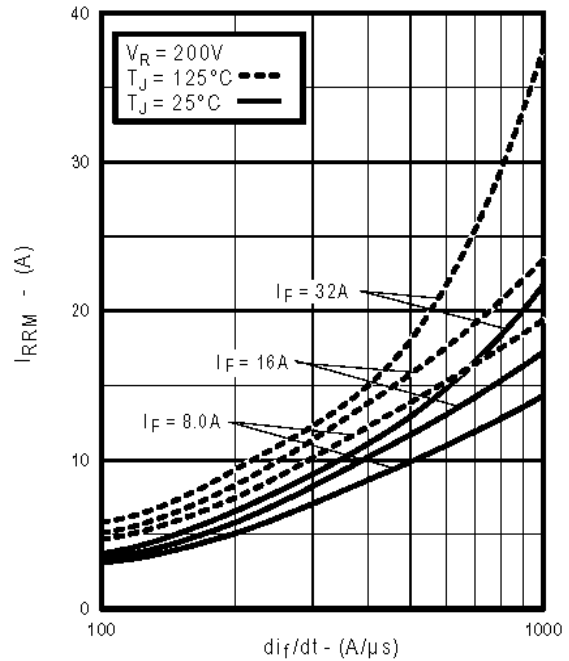

Fig. 15 - Typical Recovery Current vs. di_f/dt

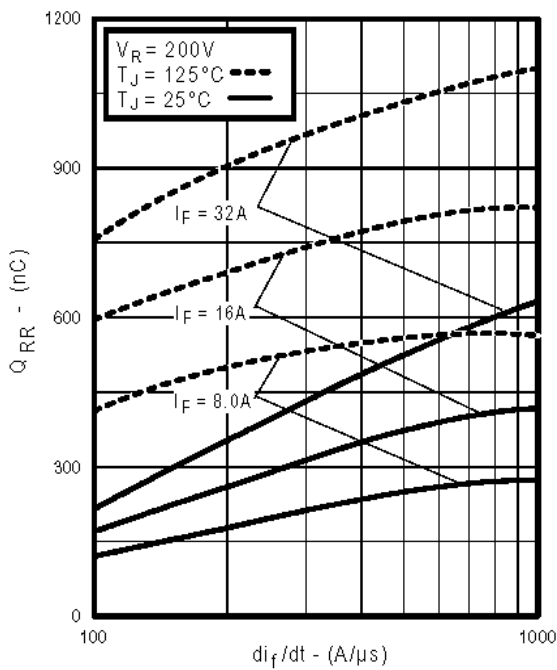

Fig. 16 - Typical Stored Charge vs. di_f/dt
www.irf.com

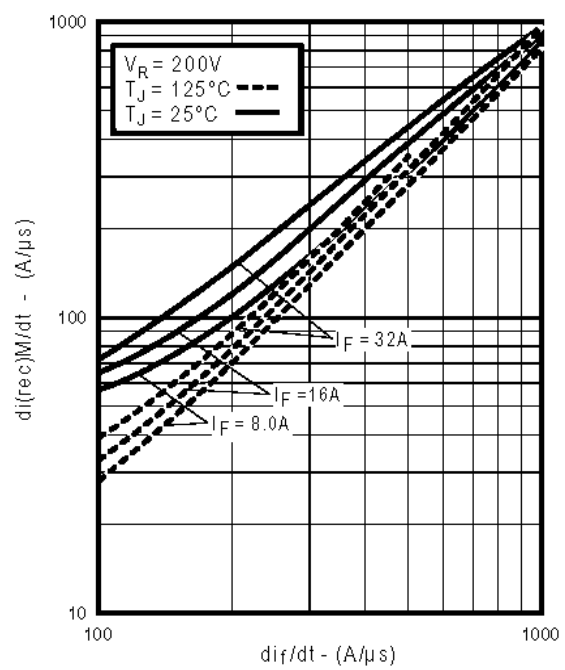

Fig. 17 - Typical $di_{(rec)M}/dt$ vs. di_f/dt

IRG4PF50WDPbF

International
IR Rectifier

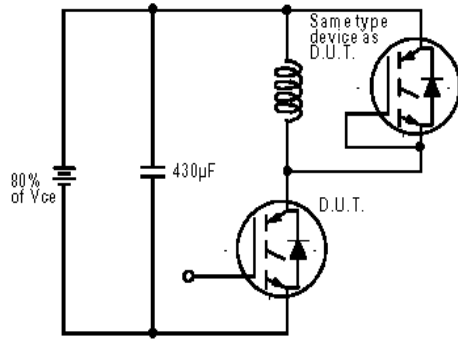

Fig. 18a - Test Circuit for Measurement of I_{LM} , E_{on} , $E_{off}(\text{diode})$, t_{rr} , Q_{rr} , I_{rr} , $t_{d(on)}$, t_r , $t_{d(off)}$, t_f

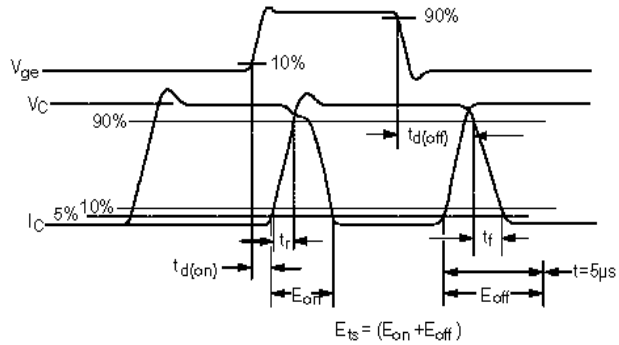

Fig. 18b - Test Waveforms for Circuit of Fig. 18a, Defining E_{off} , $t_{d(off)}$, t_f

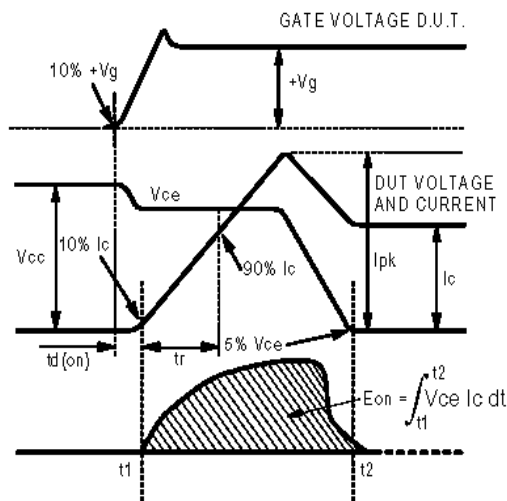

Fig. 18c - Test Waveforms for Circuit of Fig. 18a, Defining E_{on} , $t_{d(on)}$, t_r

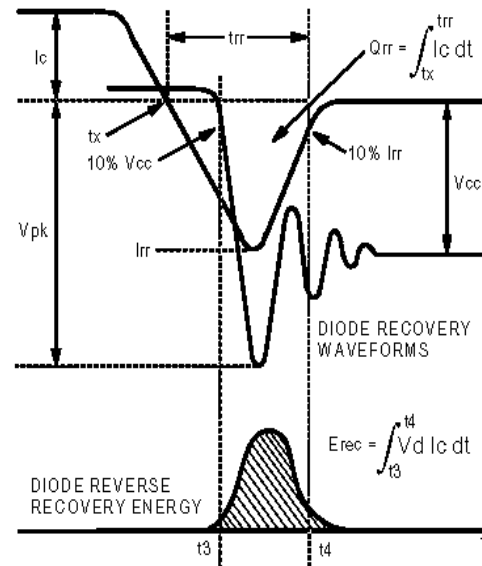

Fig. 18d - Test Waveforms for Circuit of Fig. 18a, Defining E_{rec} , t_{rr} , Q_{rr} , I_{rr}

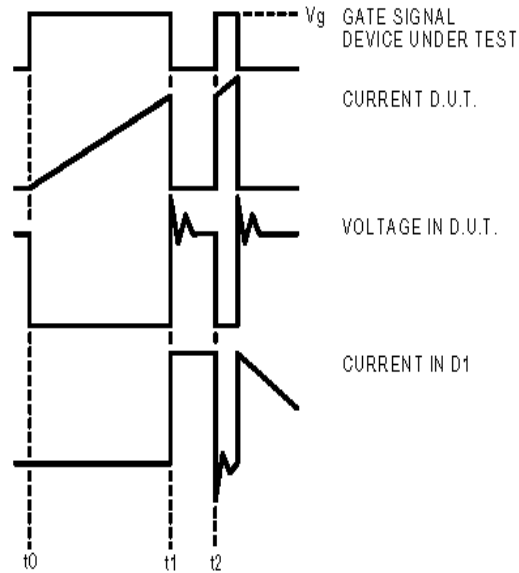

Figure 18e. Macro Waveforms for Figure 18a's Test Circuit

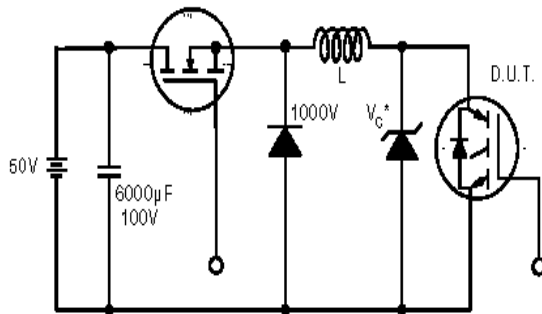

Figure 19. Clamped Inductive Load Test Circuit

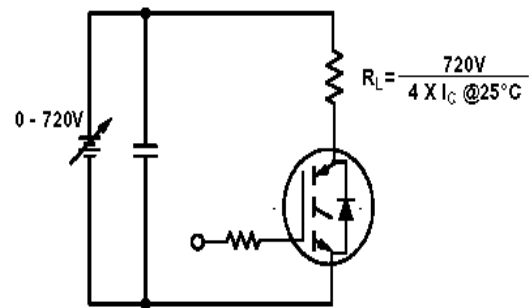

Figure 20. Pulsed Collector Current Test Circuit

IRG4PF50WDPbF

International
IR Rectifier

TO-247AC Package Outline

Dimensions are shown in millimeters (inches)

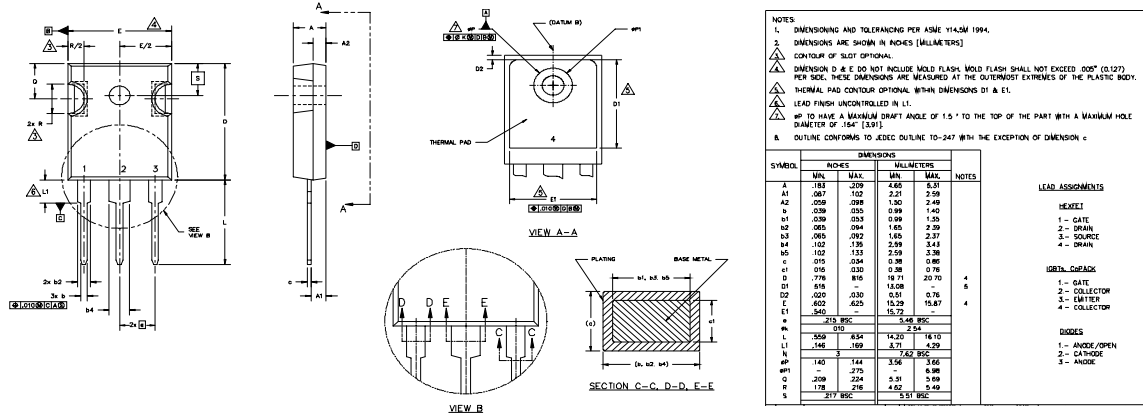

TO-247AC Part Marking Information

EXAMPLE: THIS IS AN IRFPE30
WITH ASSEMBLY
LOT CODE 5657
ASSEMBLED ON WW 35, 2000
IN THE ASSEMBLY LINE "H"

Note: "P" in assembly line position indicates "Lead-Free"

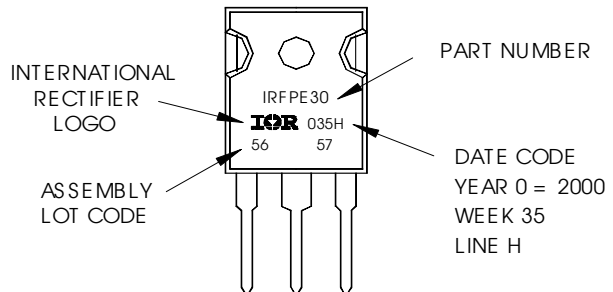

Data and specifications subject to change without notice.

International
IR Rectifier

IR WORLD HEADQUARTERS: 233 Kansas St., El Segundo, California 90245, USA Tel: (310) 252-7105
TAC Fax: (310) 252-7903

Visit us at www.irf.com for sales contact information. 04/04

www.irf.com

Note: For the most current drawings please refer to the IR website at:
<http://www.irf.com/package/>

Mouser Electronics

Authorized Distributor

Click to View Pricing, Inventory, Delivery & Lifecycle Information:

[Infineon:](#)

[IRG4PF50WDPBF](#)